

Jones Beach State Park

New York State Office of Parks,
Recreation & Historic Preservation



Jones Beach State Park
Wantagh, New York
11793

Historic Structures &
Cultural Landscape
Report



2013

Prepared By:
Erin Moroney
Building & Landscape
Conservation Unit

Edited By:
Julian Adams,
Agency Preservation Officer &
Director, Bureau of Community
Preservation

Division for Historic Preservation

New York State Office of Parks,
Recreation & Historic Preservation

EXECUTIVE SUMMARY

This historic structure report and cultural landscape report documents the construction, history and use of Jones Beach State Park. This report is limited to historic structures and landscape features identified as contributing features in the National Register Nomination (2005). Despite their significance, parkways, causeways and bridges are not covered in this report.

Jones Beach State Park has been recognized for its significance in recreation, planning, architecture and landscape architecture. The scale and magnitude of design and construction of Jones Beach was unprecedented in Park planning in New York State or the country.

Robert Moses, the famous 20th-century park and city planner, is the primary creator of Jones Beach. It was his vision and perseverance that made Jones Beach a reality. Jones Beach was designed for a very specific patron: the car owning, city dwelling middle class. The Park was designed to provide safe public recreation in a clean and beautiful setting. Gone were the rundown commercial boardwalks and amusements parks of the 19th century and in their place was a magnificent beachside city.

Jones Beach was designed on a formal Beaux Arts plan: symmetry and hierarchy were employed to establish order and harmony. The park plan includes the ocean and bay fronts, the roadways, pedestrian paths, boardwalk, recreation areas, parking areas and buildings. The centerpiece of the plan is the 231-foot high Water Tower, set at the intersection of the two main roadways, the Wantagh State Parkway and the Ocean State Parkway.

The sheer size of the Park and the structures illustrates the massive visitation anticipated by the Park planners. If anything, the popularity of Jones Beach has exceeded initial estimates with visitation increasing from 3.5 million in the 1930's to more than 14 million visitors in the peak years of the 1960's. Today, Jones Beach remains a very popular summer destination with millions of visitors a year.



History

Jones Beach was designed by a core team of architects, engineers and landscape planners working under Robert Moses. The team included Herbert Magoon (architect), W. Earle Andrews (supervising architect/engineer), A. E. Howland (engineer) & Clarence Combs (landscape architect). Robert Moses was a demanding and active participant in the Park's design; providing design ideas and granting final approval. Almost all major project architectural drawings from the 1920's through the 1960's featured Moses' signature.

Jones Beach State Park was an unprecedented type of park that was designed and construction on a monumental scale. The natural landscape was totally redesigned in an extraordinary engineering feat that converted an inaccessible, wind-swept, tidal island into the nation's first fully-planned seaside recreation area.

The creation of Jones Beach required a complete redesign of the natural landscape to accommodate parking areas, athletic fields, pathways, boardwalks, bathing beaches and buildings. A completely new network of roads, causeways and bridges also had to be designed to provide access. Services including electricity, plumbing, sewage treatment, and maintenance all needed to be designed and built.

Thousands of workers were recruited to construct Jones Beach. By the early 1930's the core of the Park plan had been fully executed. City planners from around the world came to view Jones Beach and marvel at the landscape, buildings and infrastructure.

The park was constructed in three phases between 1925—1955¹
Phase I (1925-34) Completion of the core of Jones Beach including the beach, roads, causeways, bridges & significant buildings and landscapes.

Phase II (1935-43) Depression era state and federal relief funds allow for expansion of Park features including roads, buildings and parking fields.

Phase III (1944-55) Major increase in funding to improve and renovate existing infrastructure and the creation of new facilities.

¹ LaFrank, Kathleen. National Register Nomination Form (2005)



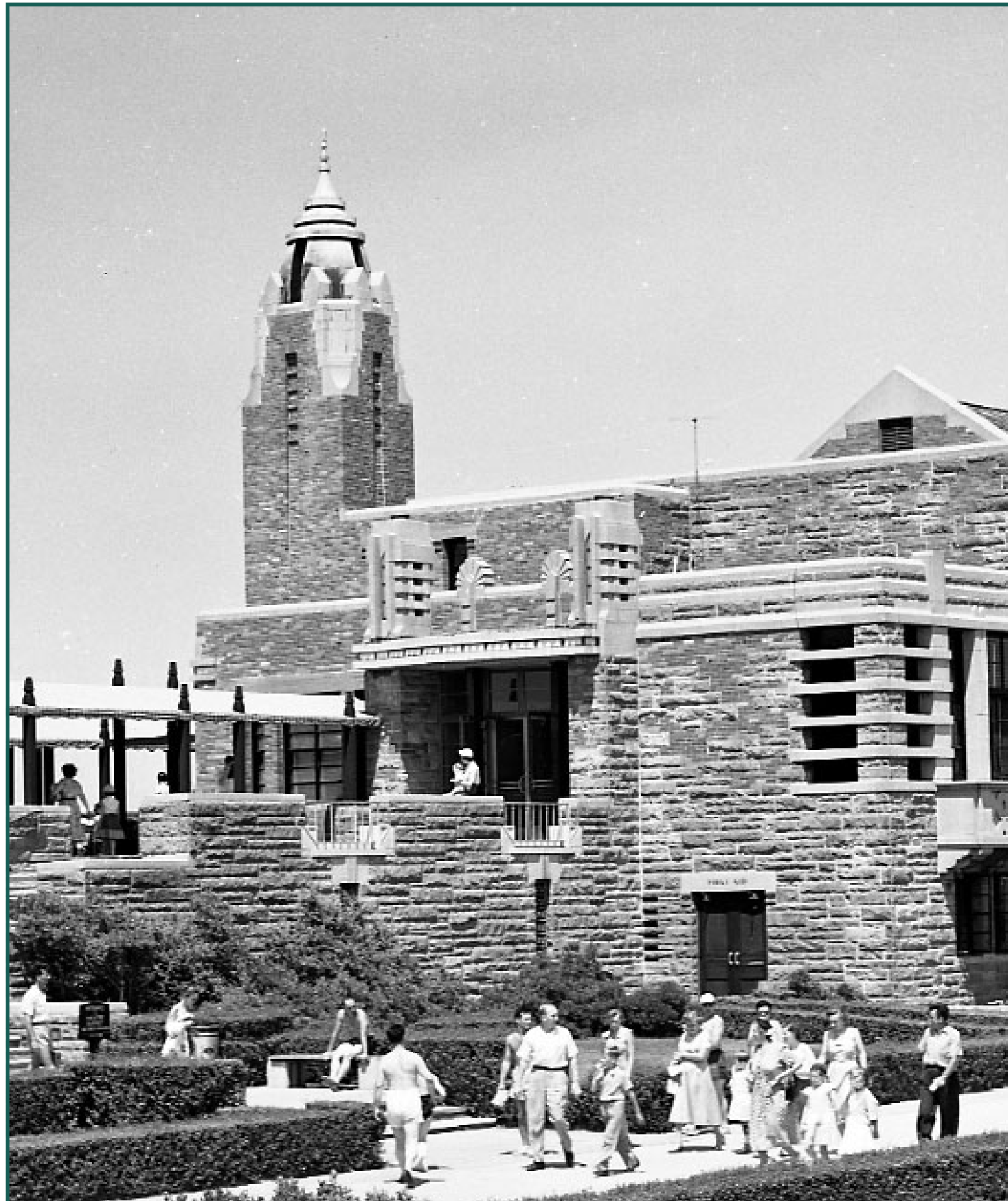

Characteristics

Jones Beach is monumental and complex yet completely harmonious. Every need and convenience was planned for and thoughtfully executed. Visual interests, beauty and fun were all considered important needs that are reflected in the final design.

The repeated use of materials, architectural style and design helps unify the Park. Materials were used to establish a hierarchy of facades and spaces while maintaining a unified pallet of colors and materials to tie dissimilar elements of the park together. A clear hierarchy of materials was used at Jones Beach to identify significant building, spaces & facades.

Materials: Buildings were constructed of Barbizon Brick, Ohio sandstone and cast stone. Tradition holds the R. Moses specifically selected the brick and stone to be used at Jones Beach after seeing the Barbizon Hotel (1927) in Manhattan.

- Barbizon brick: The brick features a pallet of muted reds, oranges, and yellows with a very low percentage of black brick. The brick has slightly irregular edges and features small inclusions. The brick was typically set in the American Common bond with accent courses of header, rowlock, soldier, sailor and projecting brick.
- Ohio Sandstone: The sandstone featured a pallet of buff, yellow, orange and grayish-blue. The sandstone was either rock faced or honed smooth. The more sandstone used on a façade the more significant the façade.
- Cast Stone: The cast stone was a light buff color with exposed aggregate. Cast stone was used primarily to execute the Art Deco ornament. Cast stone was also used for window sills and lintels and on canopies, balconies and terraces. Cast stone was also used for custom designed, built in lighting fixtures.
- Copper, wood and bronze trim elements were used to accent the buildings. Copper and bronze were both also used for custom designed lighting features.

Architectural Style: A formal Beaux Arts design is at the heart of the Park plan and the main buildings at Jones Beach. Symmetry, hierarchy, sculptural design, abundant ornament and subtle use of polychromy define and unify the buildings in the Park. Art Deco motifs were applied over the Beaux Arts design lending a whimsical and engaging touch to the buildings. Buildings and structures featured Art Deco inspired design elements including modern streamlined elements & repeated geometric shapes.

Massing & Scale: The buildings, with the exception of the Water Tower, are generally low, horizontal structures. The horizontal nature of the buildings is reinforced by bands of cast stone trim, rows of windows, canvas awnings and low pitched roofs. The building are anchored by symmetrically set, square masonry towers. The Water Tower is the one vertical element in the Park, providing an iconic reference point, visible from almost all locations in the Park.

Layout: Beach front buildings were designed to connect the interior and exterior and to flow seamlessly from north to south. Buildings features windows & open passageways that provided views of the ocean at every opportunity.

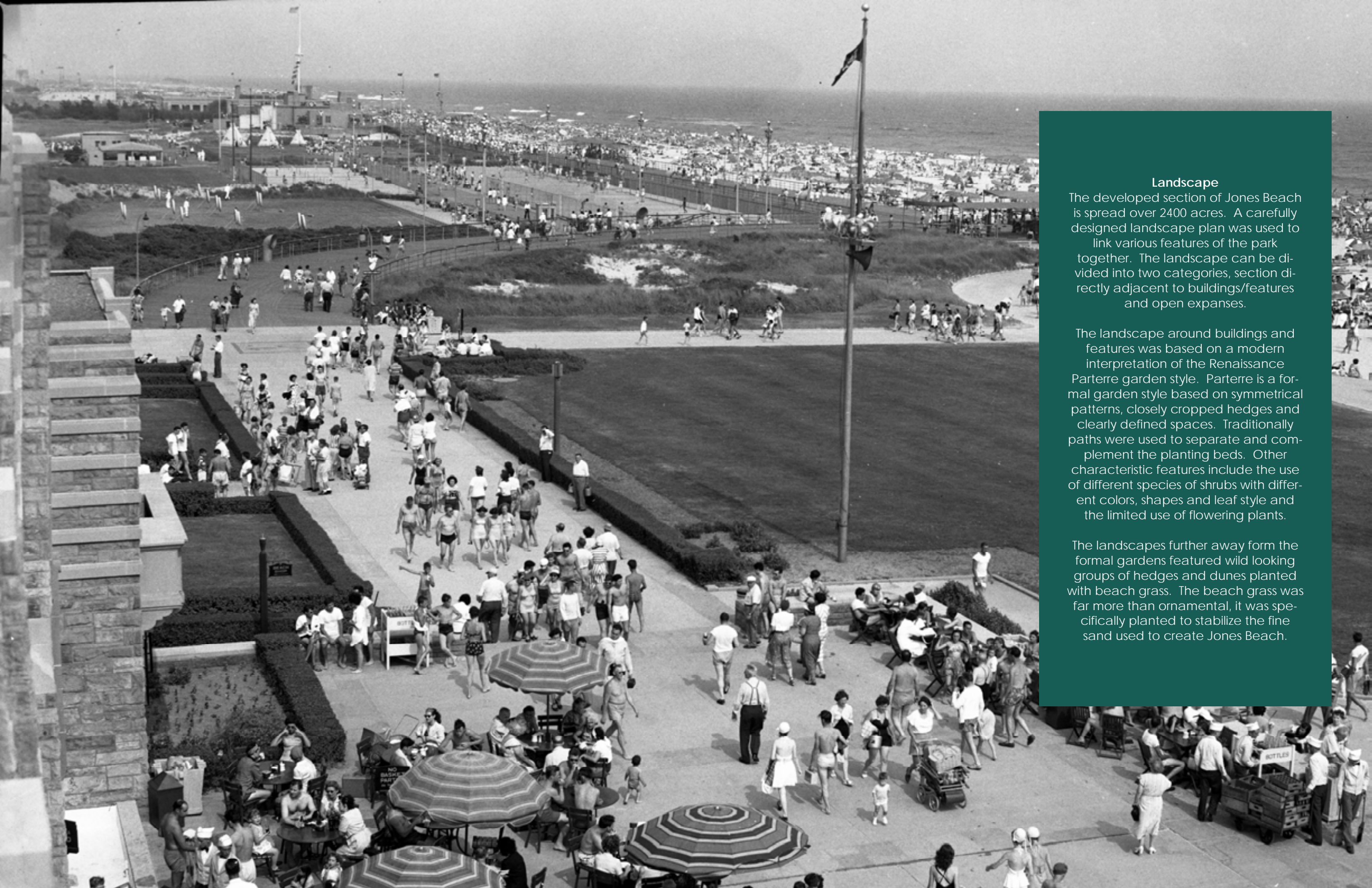

Landscape

The developed section of Jones Beach is spread over 2400 acres. A carefully designed landscape plan was used to link various features of the park together. The landscape can be divided into two categories, section directly adjacent to buildings/features and open expanses.

The landscape around buildings and features was based on a modern interpretation of the Renaissance Parterre garden style. Parterre is a formal garden style based on symmetrical patterns, closely cropped hedges and clearly defined spaces. Traditionally paths were used to separate and complement the planting beds. Other characteristic features include the use of different species of shrubs with different colors, shapes and leaf style and the limited use of flowering plants.

The landscapes further away from the formal gardens featured wild looking groups of hedges and dunes planted with beach grass. The beach grass was far more than ornamental, it was specifically planted to stabilize the fine sand used to create Jones Beach.

*Significant
Buildings & Features*

*Jones Beach State Park
Wantagh, Long Island
New York*

*New York State Office of Parks,
Recreation & Historic Preservation*



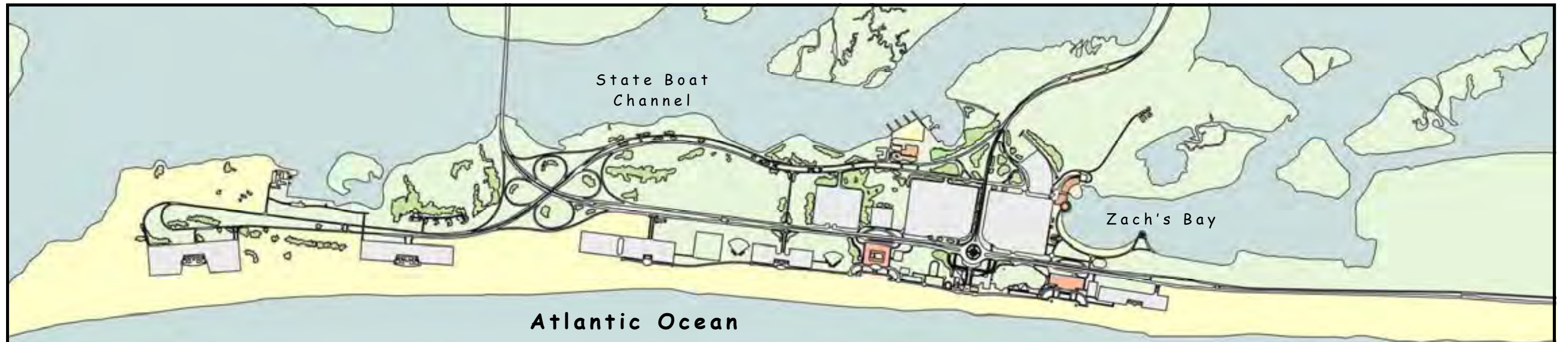

Jones Beach State Park
Wantagh, Long Island
New York

New York State Office of Parks,
Recreation & Historic Preservation

The buildings and landscape features at Jones Beach have been categorized for organizational purposes in this report.

Each major feature has been assigned to a "zone" based primarily on the historic use of the structure or feature.

Six "zones" have been established covering everything from the Water Tower to the Sewage Treatment Complex. Hopefully all of the significant features of the Park have been covered, even those that have been lost.

Regretfully all of the available information regarding these buildings/features could not be included in this report. OPRHP has thousands of original drawings and historic photographs, many of which have yet to be archived. The information in this report, however, should be sufficient to guide the preservation of the Park. As specific rehabilitation projects are undertaken more information can be provided.

Zones:

Zone 1—Central Mall

- Water Tower
- Boardwalk
- Central Mall Plaza
- West Mall Building
- East Mall Building
- Administration Building

Zone 2—The Bathhouse

- East Bathhouse
- West Bathhouse

Zone 3—The Games Areas

- East Games Area
- West Games Area

Zone 4—Comfort Stations & Bathhouse

- Parking Fields 3, 4, 5 & 10
- Comfort Stations & Parking Fields at 1, 2, & 6

Zone 5—Infrastructure

- Police Headquarters
- Gas Station & Pump House
- Maintenance Storehouse
- Commissary
- Sewage Treatment Complex
- Pump Houses & Electrical Vaults
- Fort Benedict Reservoir
- Watchman's Booth
- Staff Residences

Zone 6—Zach's Bay

- Zach's Bay Comfort Station
- Zach's Bay Cafeteria
- Marine Theater

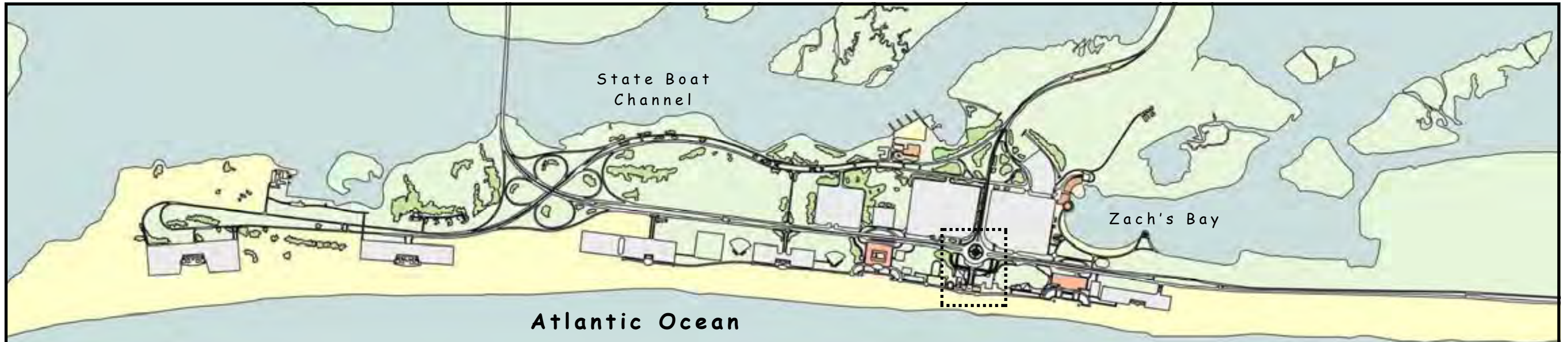

Zone 1: Central Mall

*Jones Beach State Park
Wantagh, Long Island
New York*

*New York State Office of Parks,
Recreation & Historic Preservation*

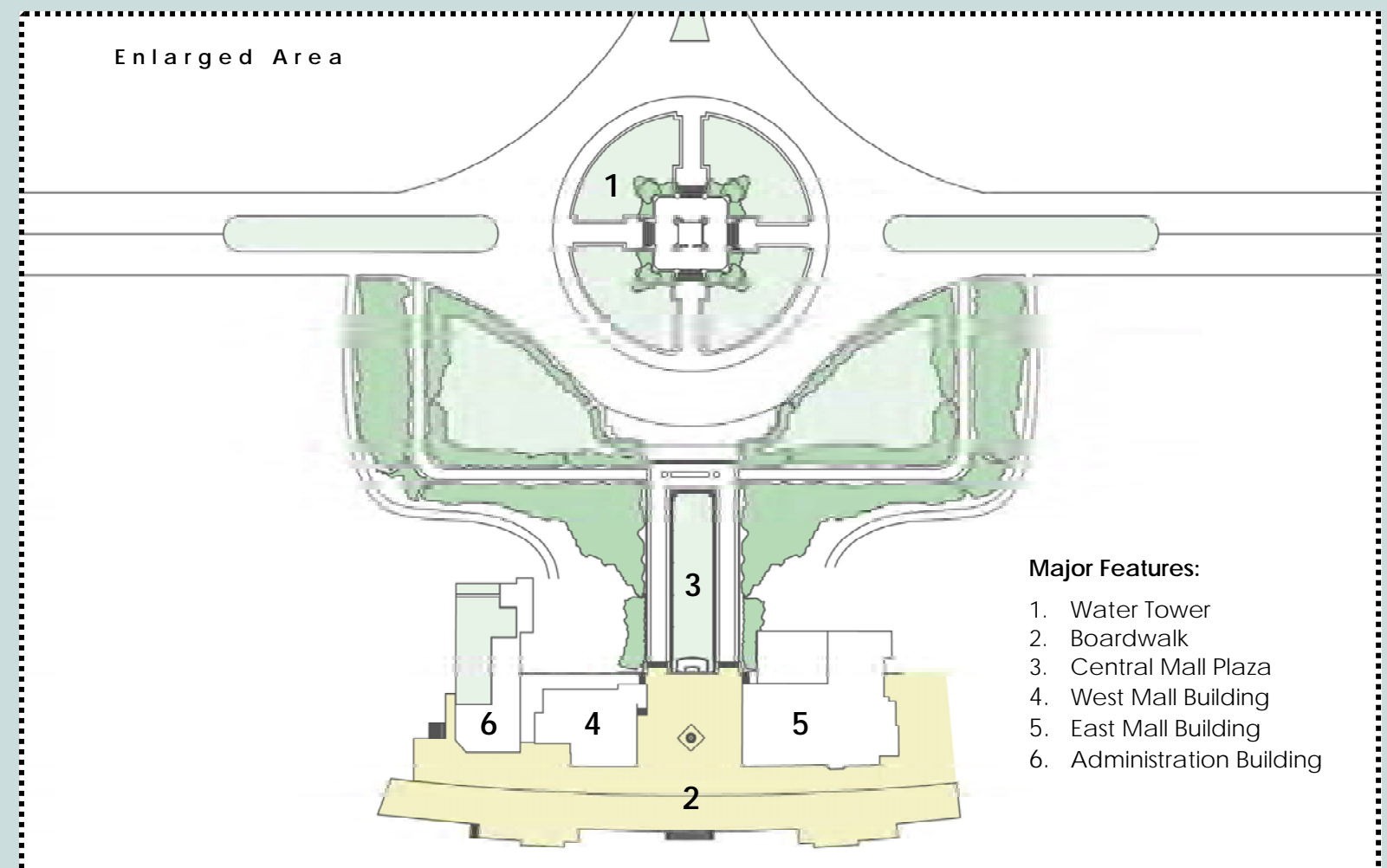

- Major Features:**
- 1. Water Tower
 - 2. Boardwalk
 - 3. Central Mall Plaza
 - 4. West Mall Building
 - 5. East Mall Building
 - 6. Administration Building

Zone 1—Central Mall

The Central Mall is the principle entrance and heart of Jones Beach. The Water Tower, the universal symbol of the Jones Beach, draws vehicles from each of the compass points to the center of the Park. Patrons are then funneled to the Central Mall plaza and finally to the Boardwalk and beach.

The Water Tower, Central Mall Plaza & Boardwalk are key elements of the formal Beaux Arts design of Jones Beach. Symmetry and hierarchy were used to establish order and harmony throughout the Park.

Symmetry was used at all levels of the Park, from the grand aerial view, to the alignment of the parkway & the location of buildings, plantings and pathways.



Aerial View: 1950's

Zone 1 Central Mall

- Water Tower (1930)
- Boardwalk (1930)
- Central Mall Plaza (1931)
- West Mall Building (1931)
- East Mall Building (1935)
- Administration Building (1950)

CHARACTERISTICS

- The Central Mall zone includes the area and buildings directly adjacent to the Central Mall Plaza—the heart of Jones Beach SP. This zone includes the Water Tower, Central Mall plaza, three adjacent buildings and the Boardwalk. The three buildings included are the Administration Building, the West Mall Building, and the East Mall Building (demolished).
- The Central Mall zone is the principle entrance to Jones Beach. The Water Tower is the main vehicular reference, the pedestrian walks lead from the parking fields funneling patrons to the Central Mall plaza and finally to the Boardwalk and beach.
- The Central Mall area is a key component of the Beaux Arts design of the Park. The strong lines of the Boardwalk, and the Central Mall define the axial components of the Park plan.
- Symmetry, materials, scale and architectural style were used to unify the area.
- The Central Mall Plaza was balanced on the north by the Water Tower and at the south by each of flanking restaurant buildings.
- All of the core buildings were set parallel to the Boardwalk reinforcing the strong lines of the Park plan.
- Despite different uses, each building was of a similar scale. Each building presents a low single story at Boardwalk level accented by masonry towers.
- Barbizon brick and sandstone were used to unify the buildings.
- Each building featured a high style beach (south) façade of sandstone accented with brick. The north facades were treated much more simply.

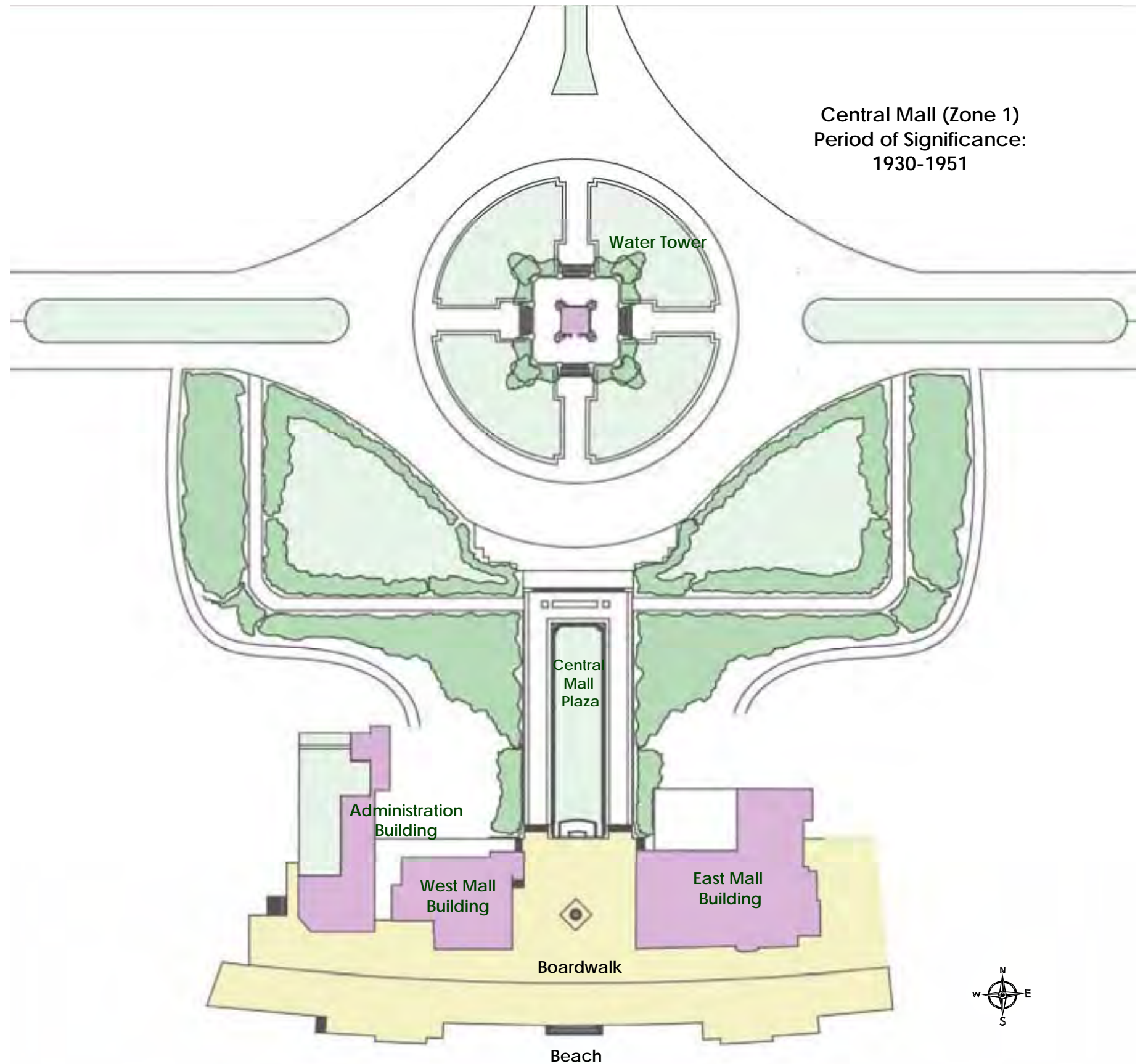

Central Mall Zone Chronology of Development 1929—2013

- 1924 Central Mall was a key element of original JPSP Plan
- 1930 1st Boardwalk Restaurant Opened (Boardwalk Café)
- 1931-1935 Temporary Buildings were constructed at key locations to maintain park plan and provide amenities. Buildings include a beach shop (6), a restaurant(5) and band shell (5).
- 1935-1951 Area is Complete—*Period of Significance*
- 1964 Fire Destroys historic Boardwalk Restaurant
- 1965 “New” modern style Boardwalk Restaurant constructed.
- 2004 “New” Boardwalk Restaurant Demolished (structural failure)
- 2004-Present First time since 1935 that the Central Mall features a vacant lot (East Mall Building) directly adjacent to Central Mall Plaza.



Period of Significance 1929-1951

1929-1935

1951

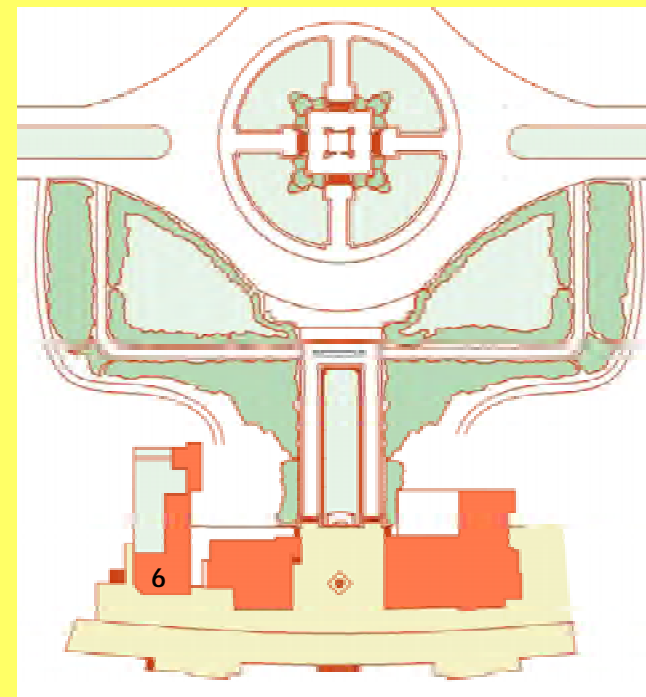
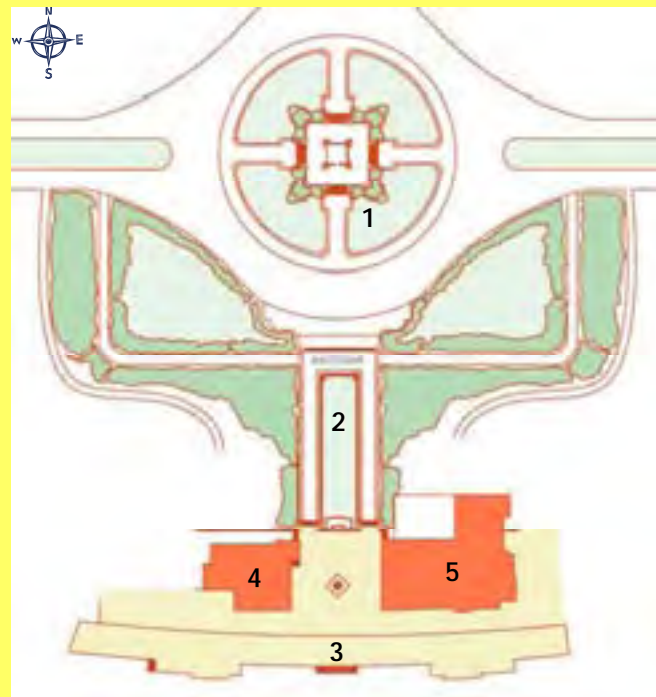

Central Mall 1929-1935

Central Mall 1950-1964

- Water Tower (1929) (1)
- Landscape, Plaza & Walkways (1929) (2)
 - Boardwalk (1929)(3)
- West Mall Building (1931)(4)
- East Mall Building (1935)(5)

- Administration Building (6)

Erosion of Park Plan & Buildings

1967-2004

2004-2013

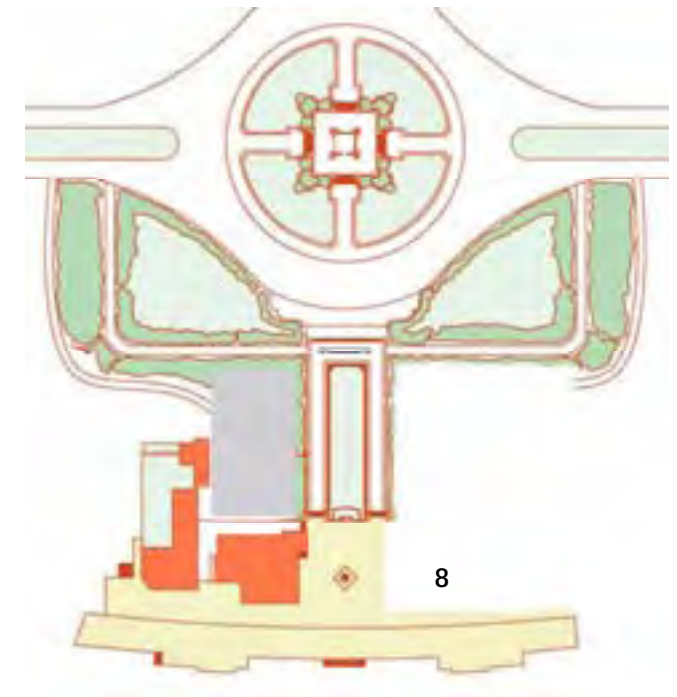
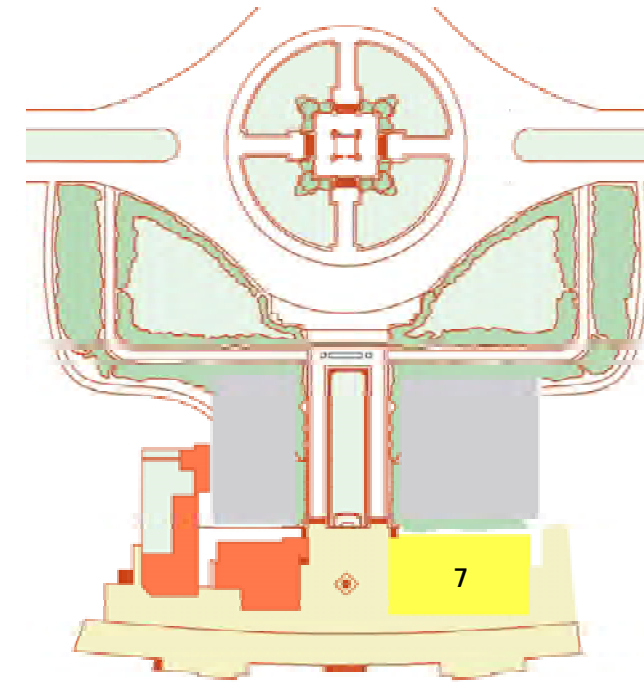

Central Mall 1964-2003

Central Mall 2004-Present

- East Mall Building destroyed by a fire in 1964.
- New Boardwalk Restaurant (1967) (7)
- Parking Expanded

- Boardwalk Restaurant demolished 2004.
- Super-Storm Sandy destroys footings for planned boardwalk restaurant. Future planning must consider post-Sandy FEMA regulations regarding shoreline construction. (8)

Zone 1—Central Mall

Key features used to unify the Central Mall area:

Spatial Organization:

- Axial components of plan established by lines of Water Tower, Central Mall & Flag Pole (north/south) and Ocean Parkway, building alignment and boardwalk (east/west)
- The park symmetry is based around line created by Water Tower, Mall Plaza, and flag pole. This is reinforced by the location of the two mall buildings, the building towers, the central mall walkways, pedestrian walks from parking fields and driveways.
- The building's primary elevations face the boardwalk—established by the use of high style materials and details while secondary facades are treated much more simply.

Scale & Massing:

- Low horizontal profile of the buildings maintains a single story at boardwalk level
- Uniform scale of the buildings and building components including bays, windows and towers.

Materials & Style

- Common materials: Barbizon Brick and sandstone with accents of copper and bronze.
- The use of the Jones Beach Architectural Style—Art Deco.
- The horizontal feel of the boardwalk buildings was reinforced by the large window openings divided into horizontal bands, the canvas fixed frame awnings and parapet details.

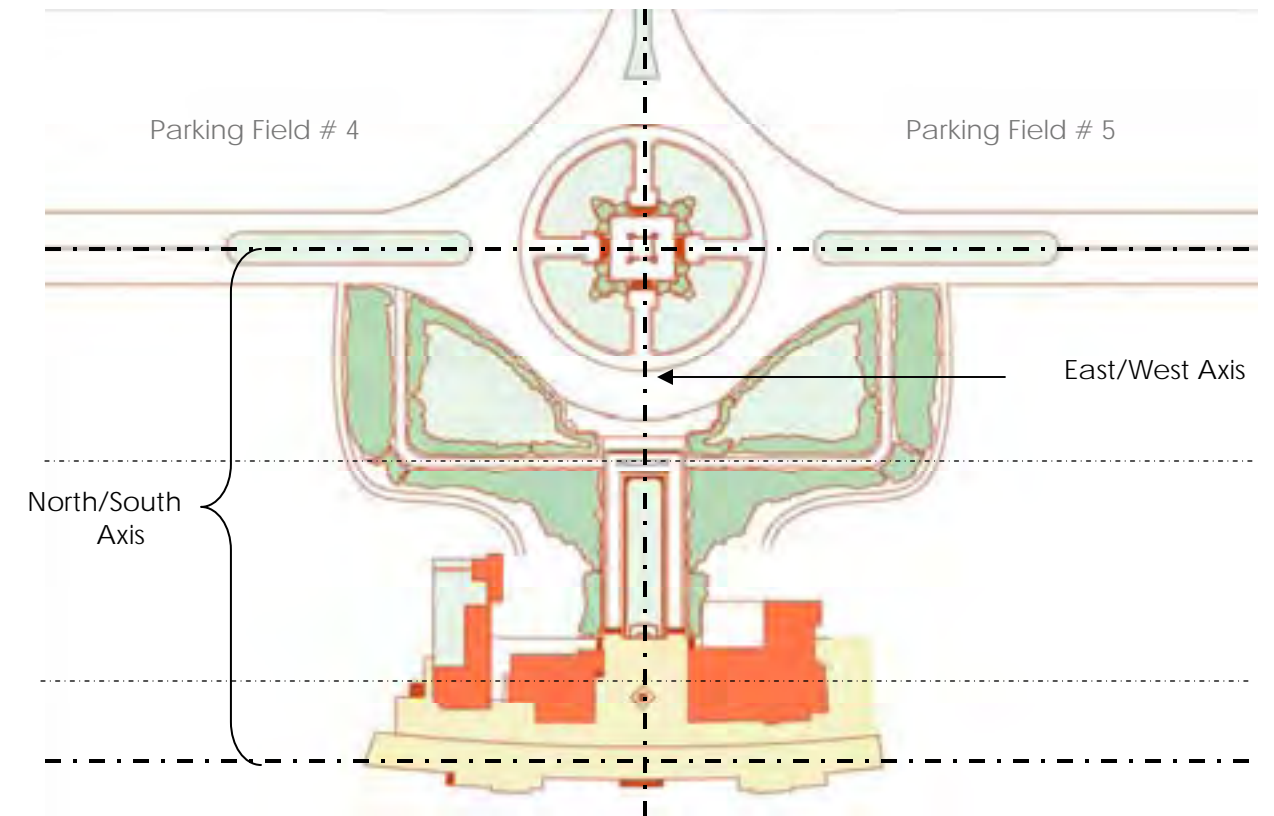

West Mall Building Tower 2013. Note Barbizon Brick, sandstone and Art Deco details.



East Mall Building c. 1949 Note tower, low massing and horizontal nature of building.

Zone 1—Features

- Water Tower (1930)
- Boardwalk (1930)
- Central Mall (1931)

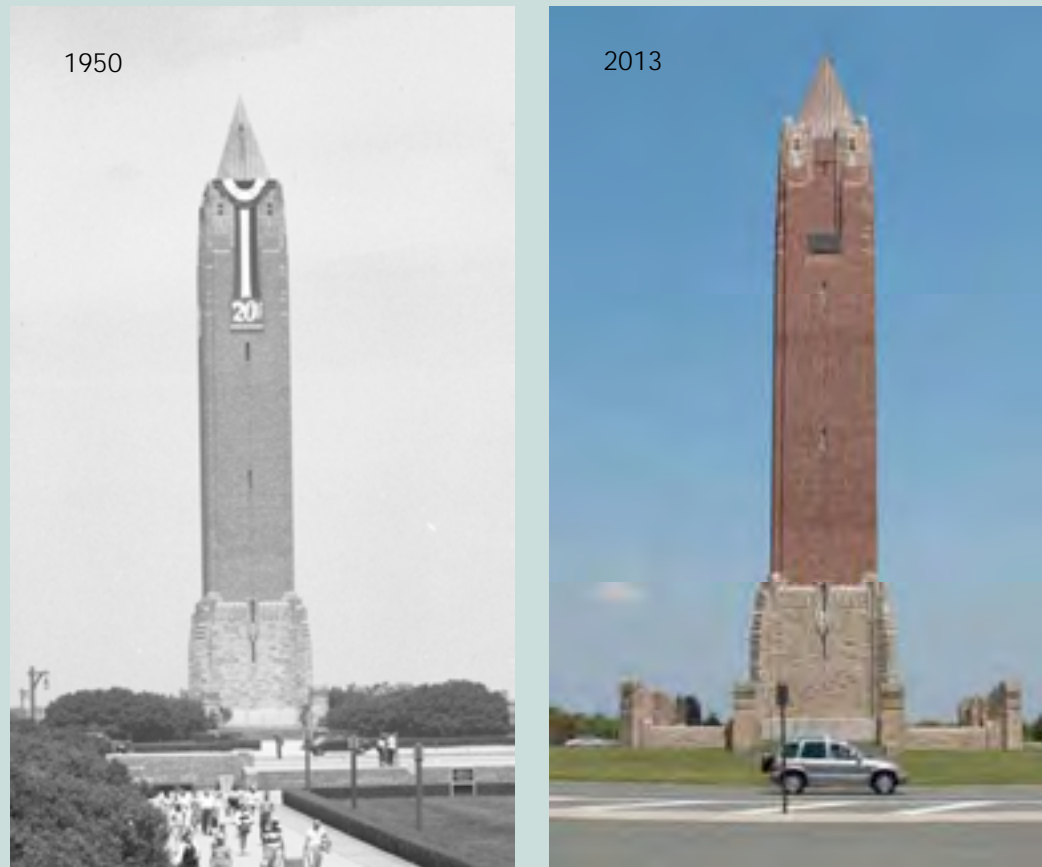

Water Tower

- A key complement of the Beaux Art Park Plan
- The main vertical element & reference point in the Park
- Art Deco Style
- Materials: Barbizon Brick & Sandstone
- Landscaping of plaza added to symmetry of park and connected the Water Tower to the Central Mall Plaza.



Central Mall Plaza

- The Central Mall plaza is the pedestrian core of Jones Beach—directing patrons from the parking fields to the Boardwalk.
- Symmetry is a key component of the design—each walkway, drive and landscape feature mirrored across the center of the Mall plaza.
- Common paving materials link the area including buff colored concrete, slate and stone mosaics.
- Landscape features are also used to reinforce the symmetry of the area and clearly define walkways. The landscape was design to allow patrons to emerge from the vast parking areas into a cool, green, plant lined walk leading before arriving at the formally planted main plaza.

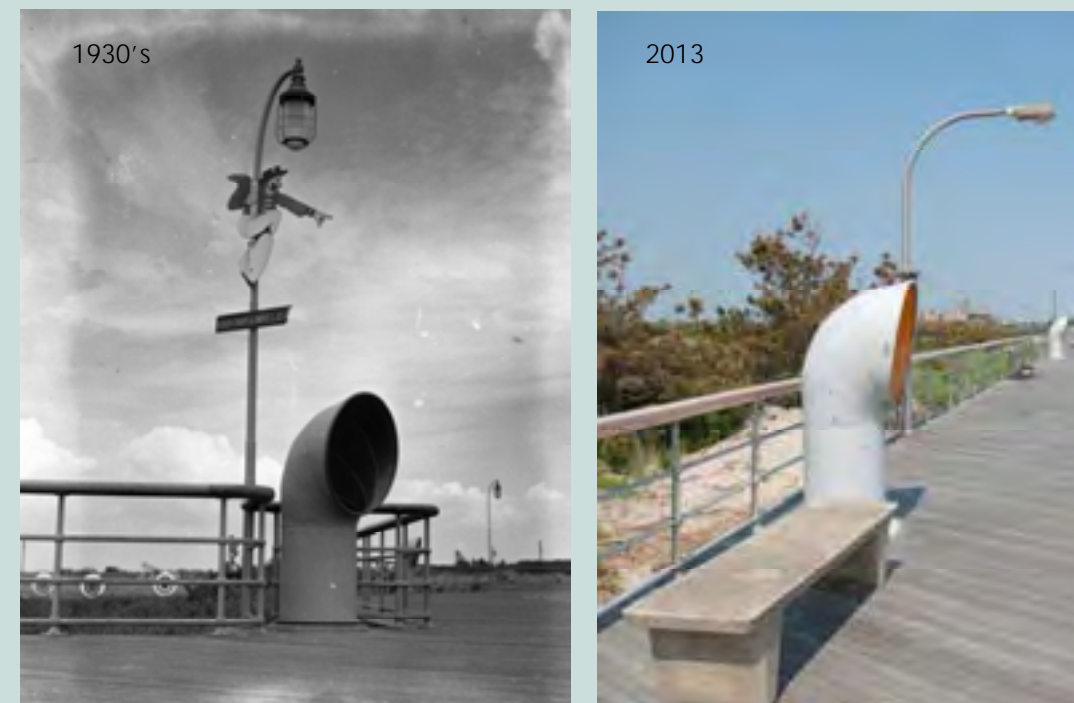

Boardwalk

- A significant component of the Beaux Arts Park Plan. One of the major horizontal elements of plan.
- Physically and stylistically links the major features of the park south of Ocean Parkway.
- Meticulously designed to maintain the whimsical—nautical theme used through out Jones Beach. Elements of the boardwalk include the nautically inspired railings, bins, water fountains and benches.
- The lighting was also scaled to the boardwalk and incorporated signage to limit clutter.

Zone 1—Features

- East Mall Building (1935)
- West Mall Building (1931)

East Mall Building

- The original East Mall Building was destroyed in a fire in 1964 and its modernist replacement was demolished in 2004. The location is currently vacant.
- A original building was a key component of the Beaux Art Park Plan. As one of the primary buildings lining the Boardwalk it reinforced the horizontal elements of plan.
- The building also significantly contributed to the symmetry of the Central Mall area; balancing the West Mall Building across the Mall plaza.
- Art Deco Style
- Materials: Barbizon Brick & Sandstone
- Massing: low horizontal structure anchored by a squat tower.
- Horizontal nature of building reinforced by the wide row of window openings, narrow bands of windows and strong lines of the parapet.



West Mall Building

- The first major building completed on the Boardwalk. The historic building is primarily intact but with significant alterations.
- The West Mall building was a key component of the Beaux Art Park Plan.
- The building also significantly contributed to the symmetry of the Central Mall area; balancing the planned East Mall Building across the plaza.
- Art Deco Style.
- Materials: Barbizon Brick & Ohio Sandstone. Copper Trim Elements.
- Massing: low horizontal structure anchored by a square masonry tower.



East Mall Building c. 1940's



'New' East Mall Building c. 1967



East Mall Building Location 2013

Zone 1—Features

- Administration Building (1950)

Administration Building

- The last major building completed on the Boardwalk.
- The building significantly contributed to the axial nature of the Park plan reinforcing the strong lines of the Boardwalk.
- Art Deco Style.
- Materials: Barbizon Brick & Ohio Sandstone. Slate trim elements.
- Massing: low horizontal structure.
- Horizontal nature of building reinforced by the wide row of window openings, narrow bands of windows and strong lines of the parapet.
- Important example of the use of primary and secondary facades at Jones Beach. High style facades faced the beach and boardwalk while non-public elevations were treated much more simply.
- The historic fixed awning (45°) with a scalloped valance have been replaced with inappropriate dome awnings.



Administration Building 2013
South & West Elevations



Administration Building c. 1949
South Elevation



Administration Building 2013
East Elevation

Zone 1—Central Mall

Temporary Buildings (1930—1950)

The construction of Jones Beach was a massive undertaking. In some cases temporary buildings were constructed to provide important public amenities, and staff needs until permanent buildings could be constructed.

At the Central Mall area temporary buildings were constructed in locations that reinforced the Beaux Arts park plan. The buildings aligned with boundaries of the mall and maintained primary façade parallel to the Boardwalk. Temporary buildings include a small restaurant that pre-dated the East Mall Building, a band shell and a boardwalk beach shop.

A temporary wood-framed administration building was also located on the east side of the Central Mall. The building was not accessed off the main plaza but from on the pedestrian walkways leading to the parking fields. The building was constructed in the mid-1930's and was not demolished until after the boardwalk level Administration Building was completed in 1950.



Beach shop c. 1935

Boardwalk Beach Shop 1934-1950

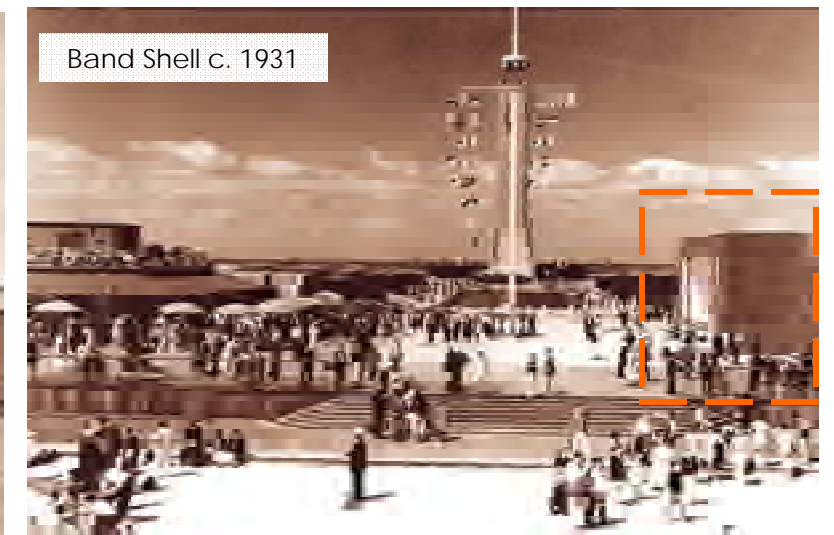

Band Shell c. 1931

Band Shell at Central Mall/Boardwalk intersection c.1931

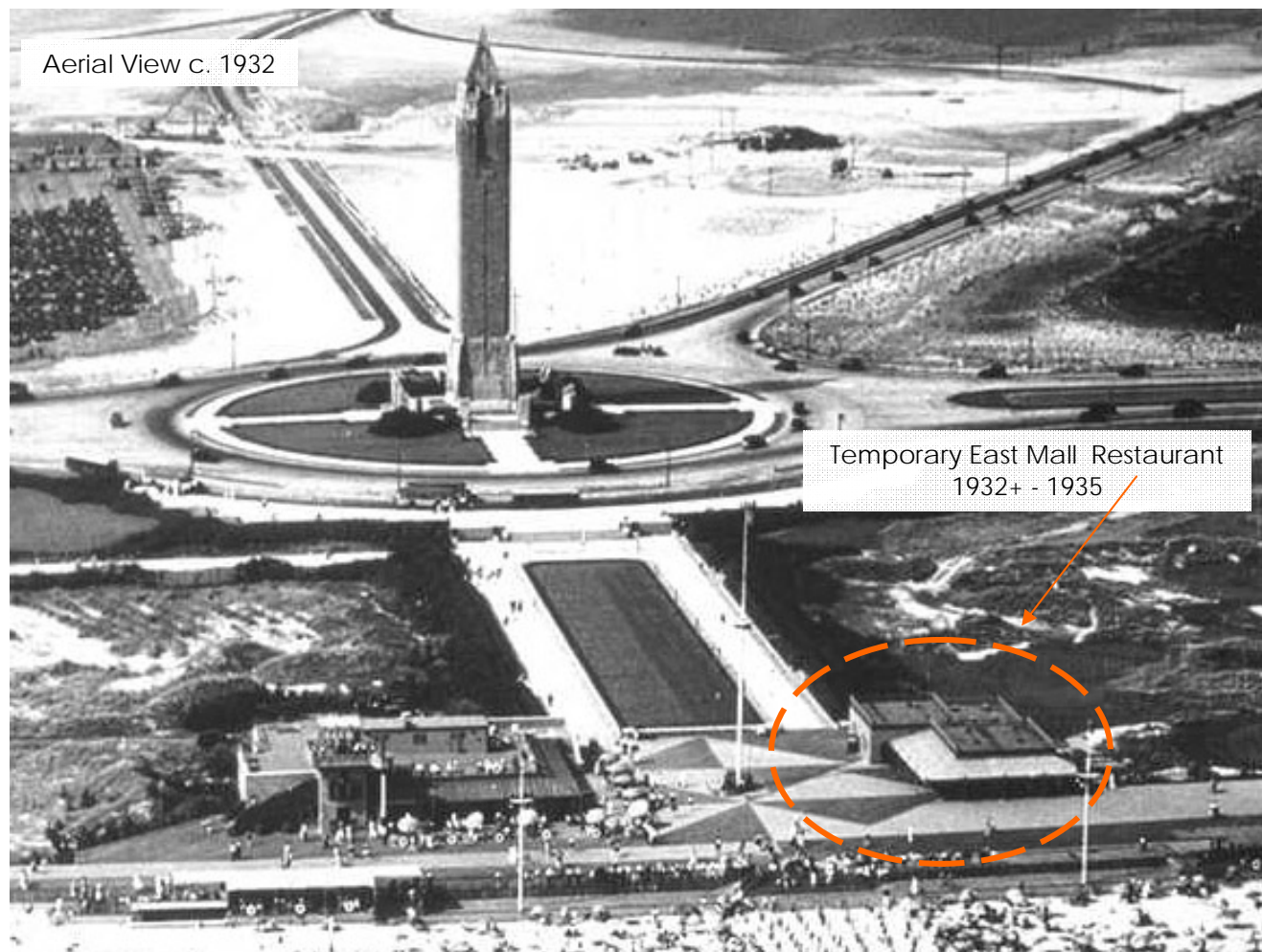

Aerial View c. 1932

Temporary East Mall Restaurant
1932+ - 1935

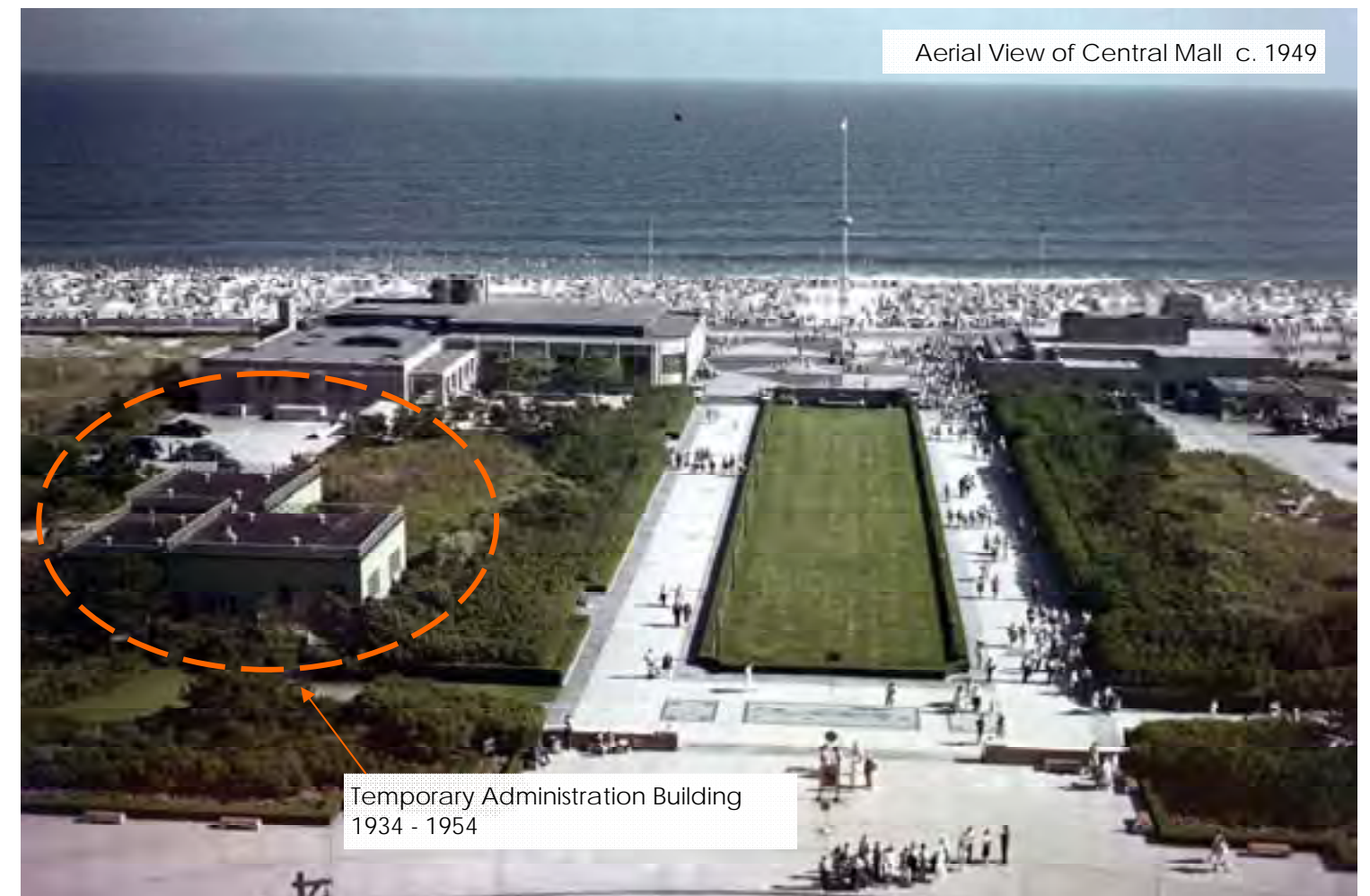

Aerial View of Central Mall c. 1949

Temporary Administration Building
1934 - 1954

Central Mall Zone Existing Conditions



Central Mall—looking south, 2013

Zone 1—Central Mall

The integrity of the Central Mall area has slowly been eroded by unsympathetic additions, deterioration and the forces of nature.

- The visual impact Beaux Arts design has been greatly diminished by the loss of the East Mall Building. The loss of this historic structure in 1964 and the loss of its replacement in 2004 has resulted in the loss of the core symmetry of the Central Mall.
- The integrity of the Central Mall has also been reduced by the erosion of the planting around the Central plaza. Expansion of parking areas and poor landscape planning has resulted in the loss of the cultivated planting around the plaza. Finally, salt water and wave damage from Super-storm Sandy killed many of the hedges that line the center of the plaza. The poor condition of the plantings has allowed Park patrons to create free form shortcuts across the plaza lawn—further damaging the space.
- The addition of a partially enclosed metal and glass wind screen in front of the Boardwalk Café has intruded on the Boardwalk and reduced the impact of the axial design of the Boardwalk and Boardwalk buildings. The materials chosen for the windscreen are also at odds with the character defining materials



Central Mall Plaza, 2013



Boardwalk & Boardwalk Cafe, 2013

ZONE 1 CENTRAL MALL: USE, SIGNIFICANCE & PRESERVATION

BUILDING SIZE & USE

Recommendation:

The Central Mall area is the heart of Jones Beach. The Central Mall (CM) itself (plaza) is the primary pedestrian entrance for millions of patrons, the Boardwalk connects all of the oceanfront facilities and the buildings provide key patron and park services.

Location/Size

| Building | Location | Sq. Foot (Aprox.) |
|--------------------|-----------------|-------------------|
| Water Tower | North end of CM | |
| Plaza | Central Mall | 45,000 sq. ft. |
| Boardwalk | Boardwalk | 7200 linear ft. |
| Admin Building | West of CM | 7000 sq. ft. |
| West Mall Building | West of CM | — sq. ft. |
| East Mall Building | Demolished | 0 sq. ft. |

Use

| Building | Historic Use | Current (2013) |
|--------------------|--------------------------------------|----------------|
| Water Tower | 350,000 gal. water tower | Same |
| Central Plaza | Entrance to Beach | Same |
| Boardwalk | Walkway | Same |
| Admin Building | Beach Shop, First Aid & Staff Office | Same |
| West Mall Building | Café | Same |
| East Mall Building | Restaurant/ Cafe | na |

SIGNIFICANCE

The Central Mall area is significant:

1. As an important component of the formal Beaux Arts plan of Jones Beach State Park: the layout of the Plaza, the boardwalk and buildings helps create the strong axial and symmetrical components of the Park plan.
2. For its architectural design: The buildings and landscape features reflect careful thought regarding use, layout, materials and design. These elements are skillfully used together to create a harmonious and unified Park.

Significant Elements include:

1. **Plan/Layout** The axial alignment of the Boardwalk and Central Mall is a critical feature of the Beaux Arts plan of the Jones Beach. This alignment is reinforced by the placement of the buildings parallel to the boardwalk.
2. **Materials.** The use of specific materials was consistent throughout Jones Beach and helped maintain a sense of unity through the large park. Important materials used include Barbizon Brick and sandstone for buildings, concrete and slate for paving and wood for the boardwalk.
3. **Scale & Profile.** The buildings adjacent to the Central Mall present a uniform low horizontal profile and a comparable scale.
4. **Architectural Style:** The use of the unique Jones Beach style featuring a combination of the Moorish and Art Deco characteristics.

Period of Significance: 1930-1951

TREATMENT

Recommendations: **Rehabilitation**

Retention and preservation of Historic Materials

1. The impact of alterations, repairs and additions should be weighed for their effect on the Park design and historic fabric.

Restoration of Historic Features

1. Reestablishment of symmetry of the Central Mall. Specifically the construction of a historically sympathetic structure/shelter/boundary on the east side of the Central Mall Plaza at the intersection with the Boardwalk to balance the West Mall building and provide a boundary on the east side of the mall.
2. Restoration of architectural details on the West Mall Building.
3. Restoration of the Central Mall Plaza including paving details, plantings and fountain.
4. Restoration of relationship between Boardwalk Restaurants and Central Mall Plaza.

Removal of Inappropriate modern additions/features

1. Removal of intrusive metal and glass windscreen and other inappropriate additions on the West Mall Building.

**ZONE 1: CENTRAL MALL AREA
WATER TOWER**

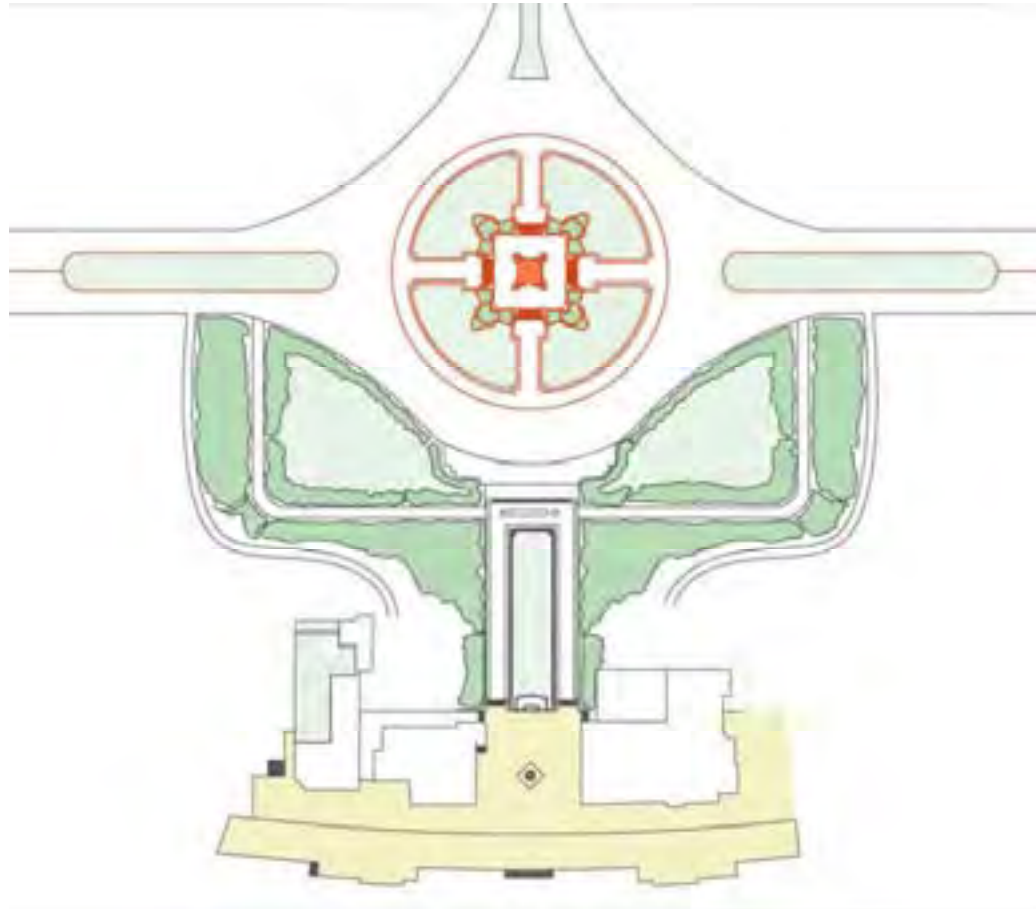

Water Tower & Plaza

WEST MALL BUILDING CHRONOLOGY OF DEVELOPMENT & USE

- The Water Tower is the iconic symbol of Jones Beach.
- The building was one of the first structured completed at Jones Beach in 1930.
- Designed in 1929 by:
 - Architect: Herbert Magoon, AIA
 - Engineers: A.E. Howland & W. Earle Andrews
 - LIPC President: Robert Moses (Final approval)
- Architecturally, the building is based on St. Mark's Campanile, Venice (1514).
- The Water Tower is the main water supply for the entire Park.
- The steel tank within the tower holds 315,000 gallons of fresh water pumped from three wells.
- As a historic resource the Water Tower includes the masonry terrace at the base of the building, the circular central plaza at the intersection of Ocean Parkway and the Wantagh Parkway and the two adjacent traffic plazas to the east and west.

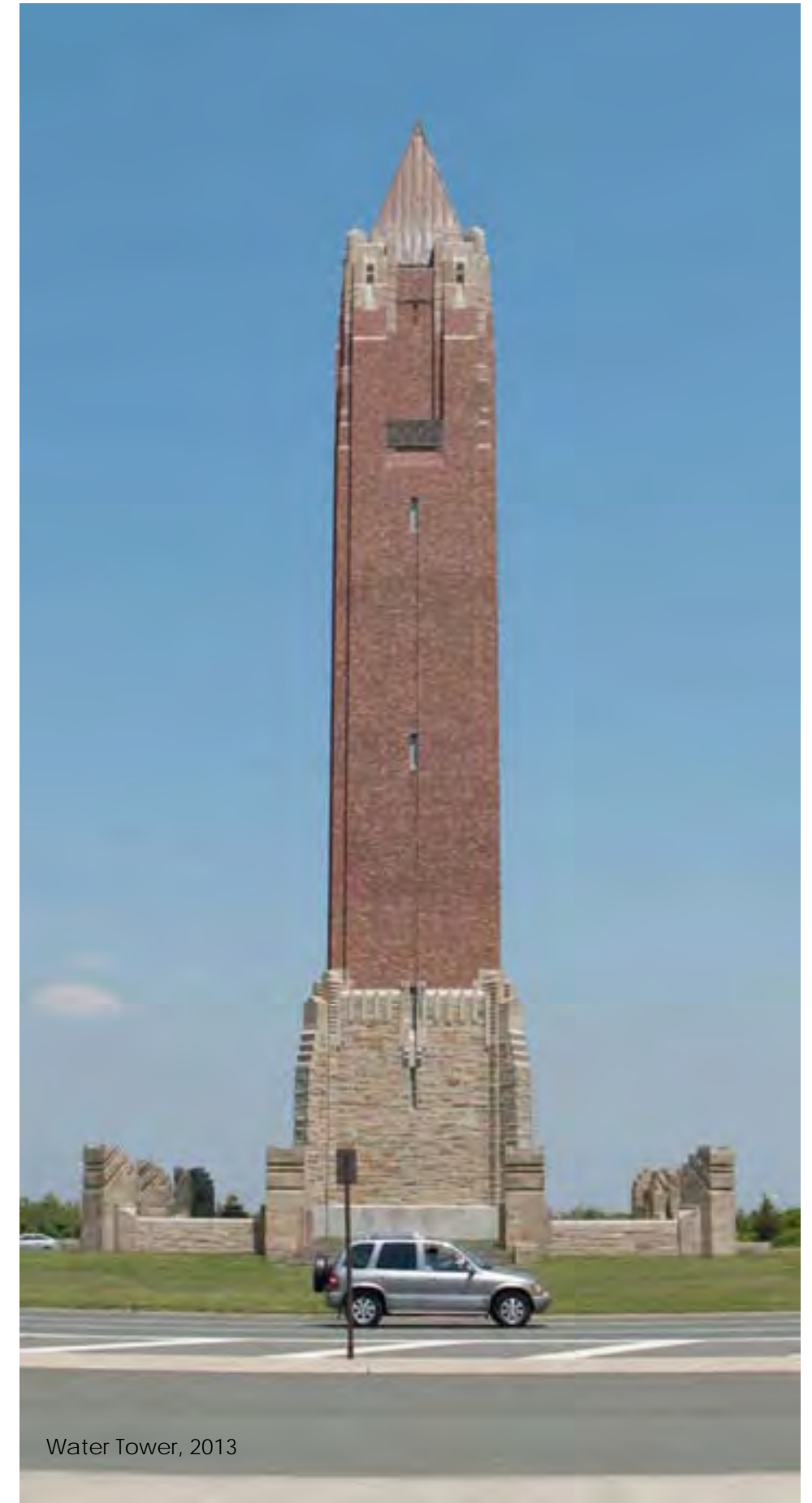

Water Tower, 2013

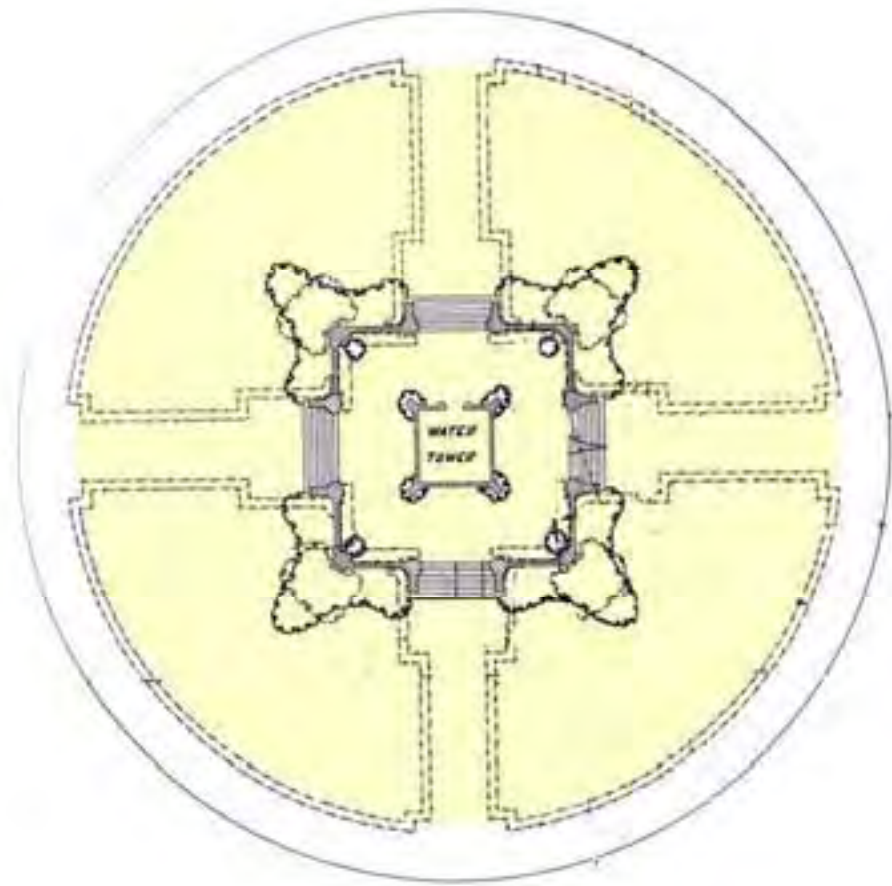

Water Tower—Central Plaza

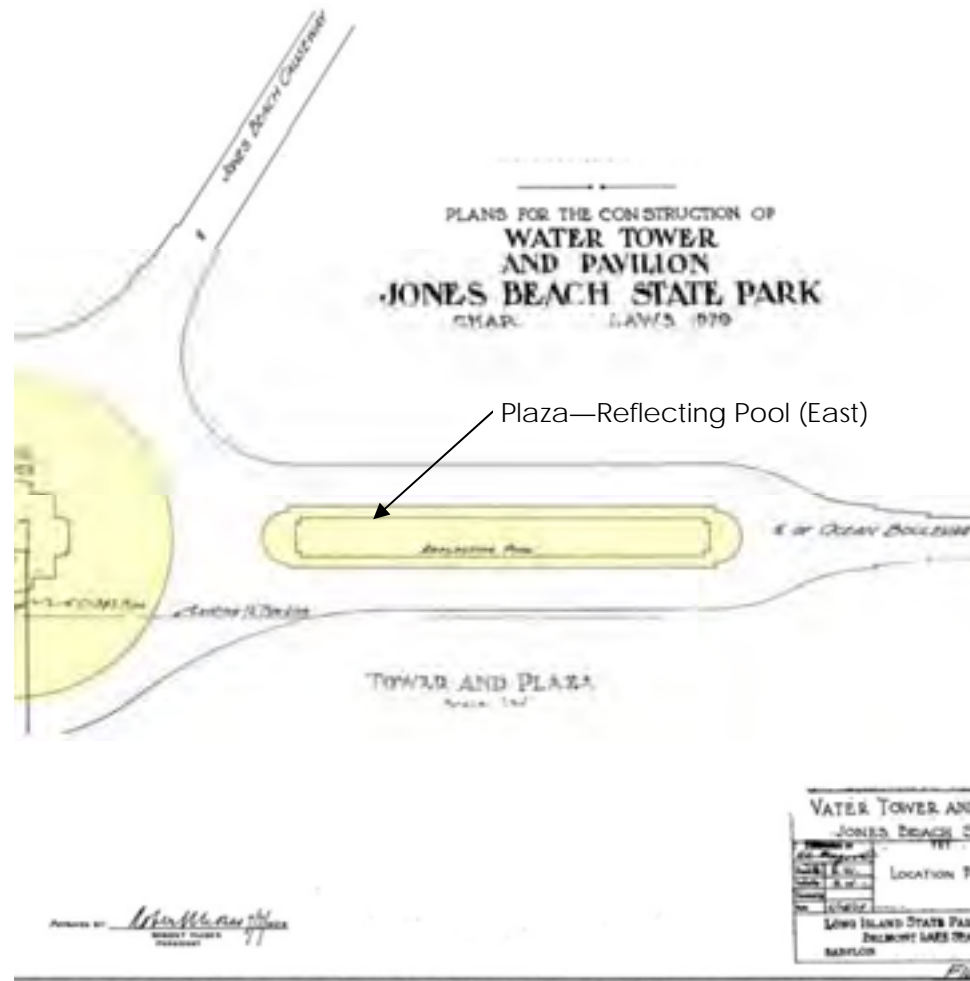

Water Tower Plaza—Plan

WATER TOWER (1930)

DESCRIPTION

EXTERIOR

- The Water Tower is 231' feet tall and 25' feet wide (brick shaft).
- The circular plaza at the foot of the Water Tower is 150' in diameter.
- The Water Tower is constructed of steel and masonry. Barbizon Brick was used with sandstone, granite and copper trim.
- The Tower is symmetrical and with the exception of the north façade, each elevation is identical.
- The Water Tower is composed of four primary components: the base, the shaft, spire and the plaza.
- The central circular plaza was originally formally landscaped with plantings, walkways and hardscape features.
- The circular plaza is flanked by oblong plazas to the east and west that are 300' long. The flanking plazas originally featured long rectangular reflecting pools and formal plantings.

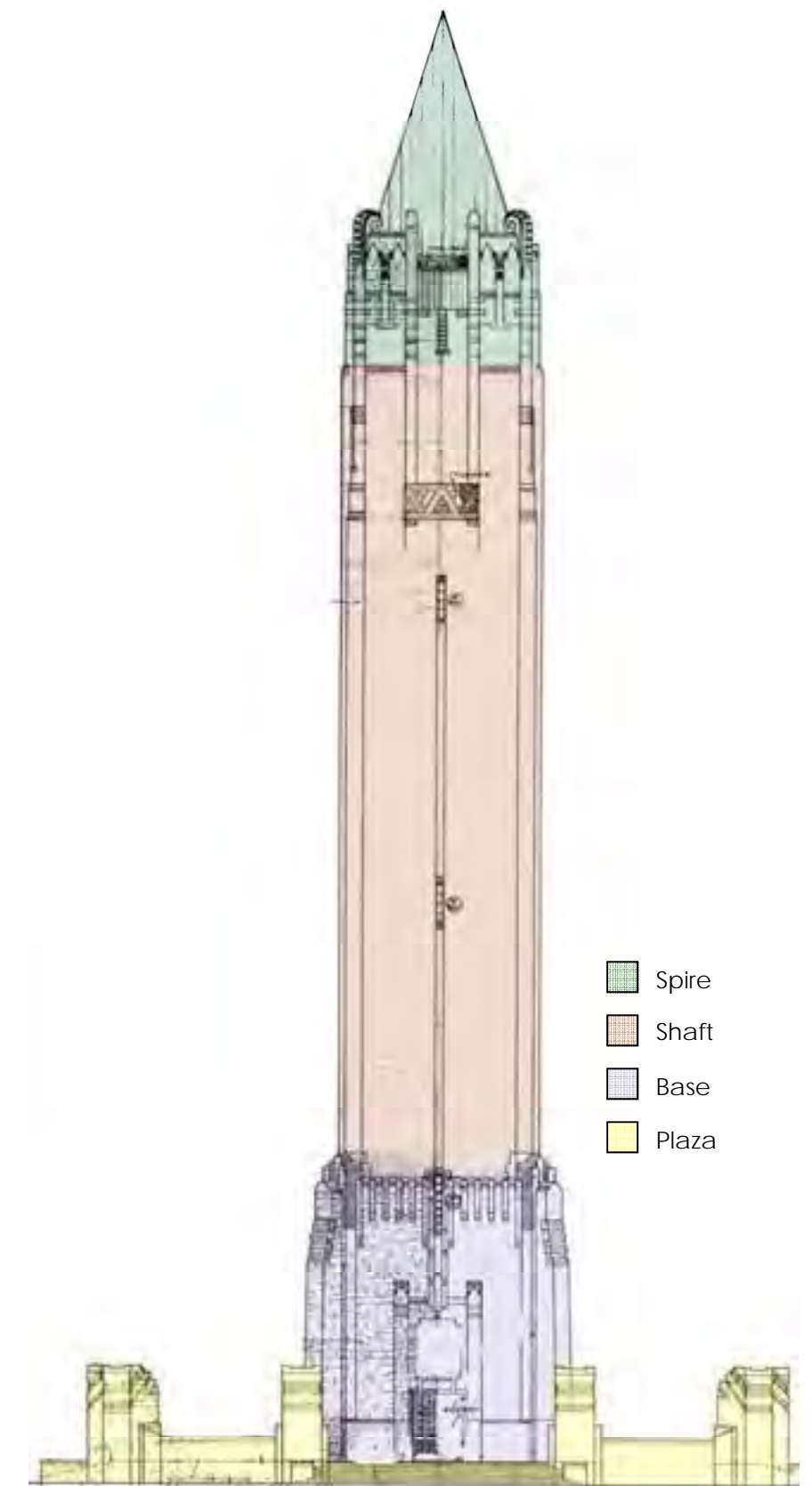

WATER TOWER (1930)

DESCRIPTION

EXTERIOR—SPIRE

- The Water Tower is 231' feet tall
- The spire is approximately 33' tall and set above the 14th Floor of the Water Tower.
- The pyramidal roof of the tower is lead coated copper.
- The Art Deco trim is primarily limestone with bands of brick trim.
- The surrounding masonry is Barbizon Brick.
- A small copper clad balustrade is set at the base of the spire. The balustrade features a raised Art Deco chevron pattern. The balustrade is set back in the masonry and is accessed at the through at trap door on the 11th floor.
- The steel water tank in the Water Tower extends up to the top of the 14th floor.
- The Water Tower was originally lit at the base, the balustrade and at the cornice level. The lights aimed upward illuminating the spire.



Water Tower Spire—illuminated at night c. 1949



Water Tower Spire—detail 2013

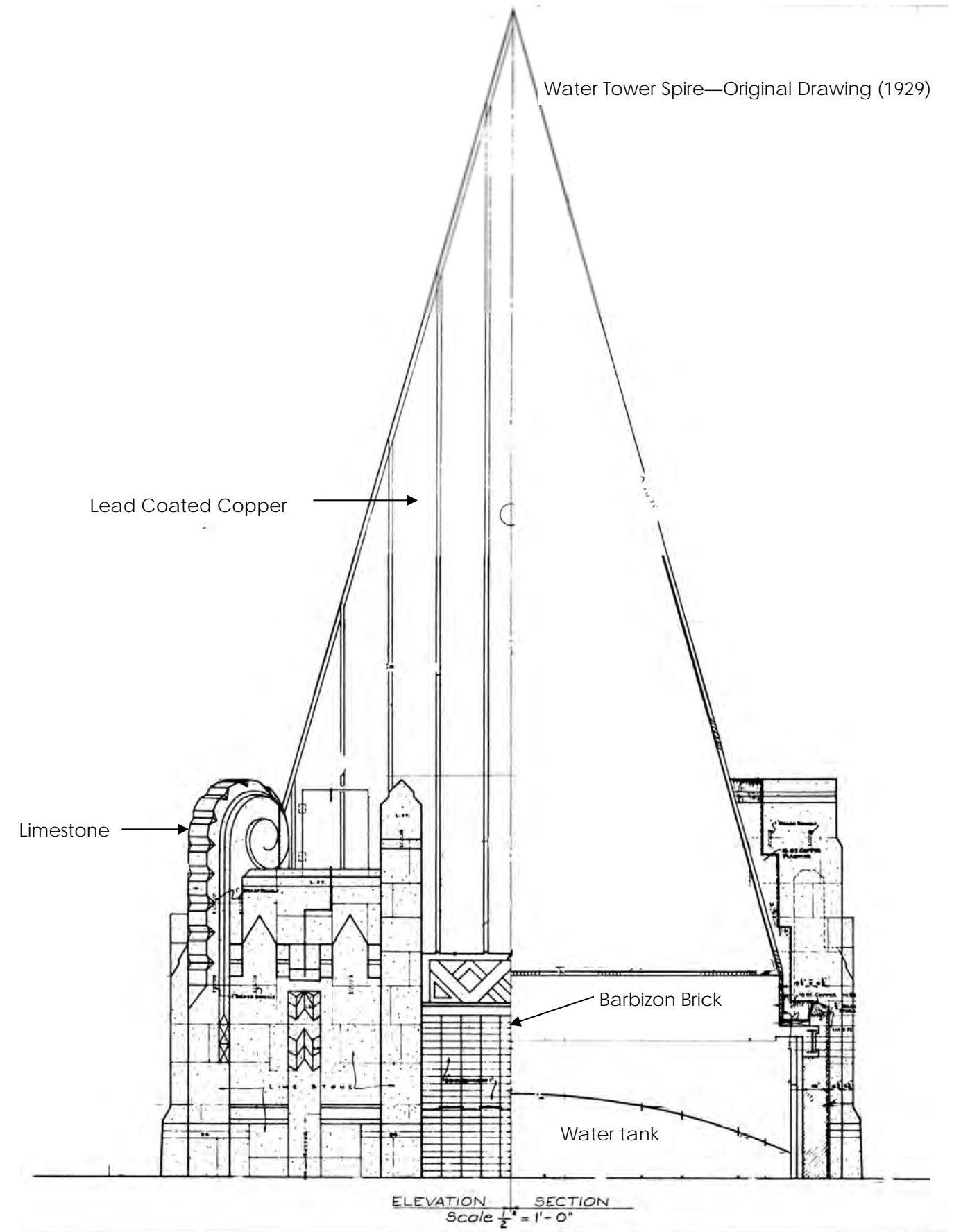

WATER TOWER (1930)

DESCRIPTION

EXTERIOR—SHAFT

- The main shaft of the Water Tower is composed of Barbizon Brick.
- The brick is set in an American common bond (five rows of stretcher brick alternating with a single row of headers.)
- Each brick façade is 25' wide.
- Each of the four identical elevations features a reveal at the center of the façade.
- Two narrow windows are centered on the reveal at the 6th and 9th floors.
- The windows feature four fixed lights set in a narrow column.
- Each of the corners features a set back that runs the length of the shaft from the base to the limestone cornice.

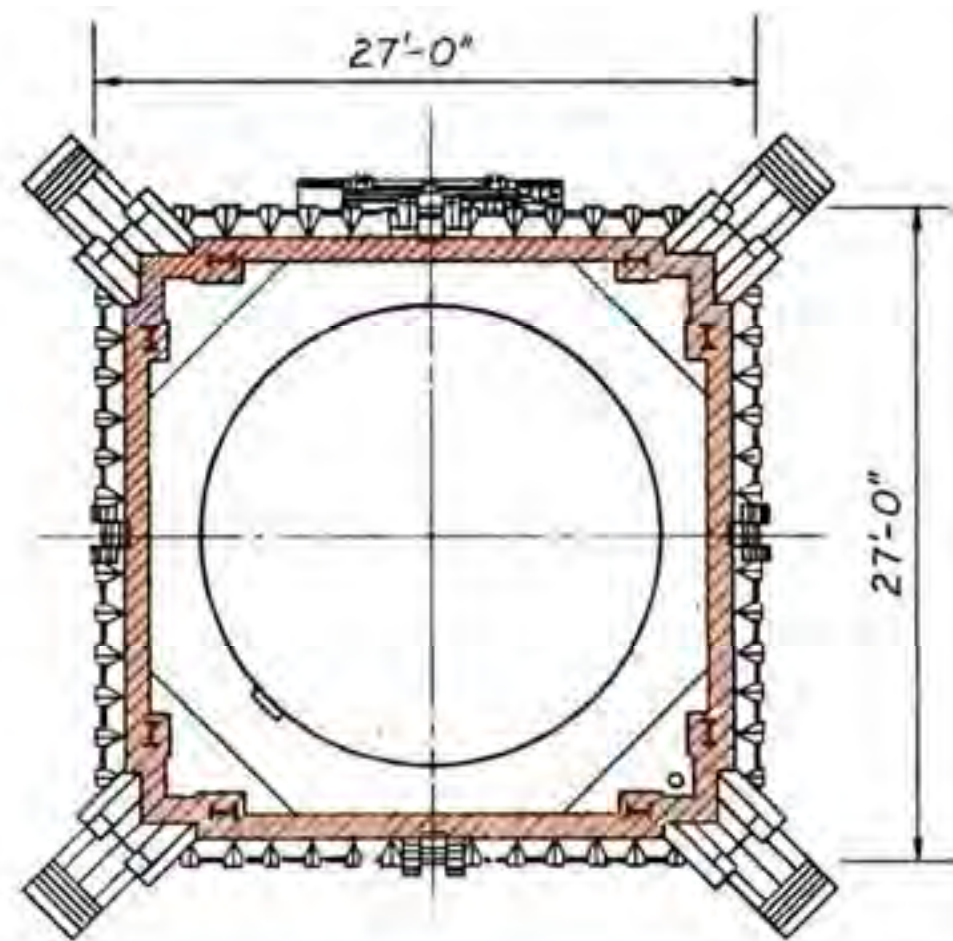

Water Tower Shaft—plan

Water Tower (1949)



Water Tower Spire—
Original Drawing (1929)

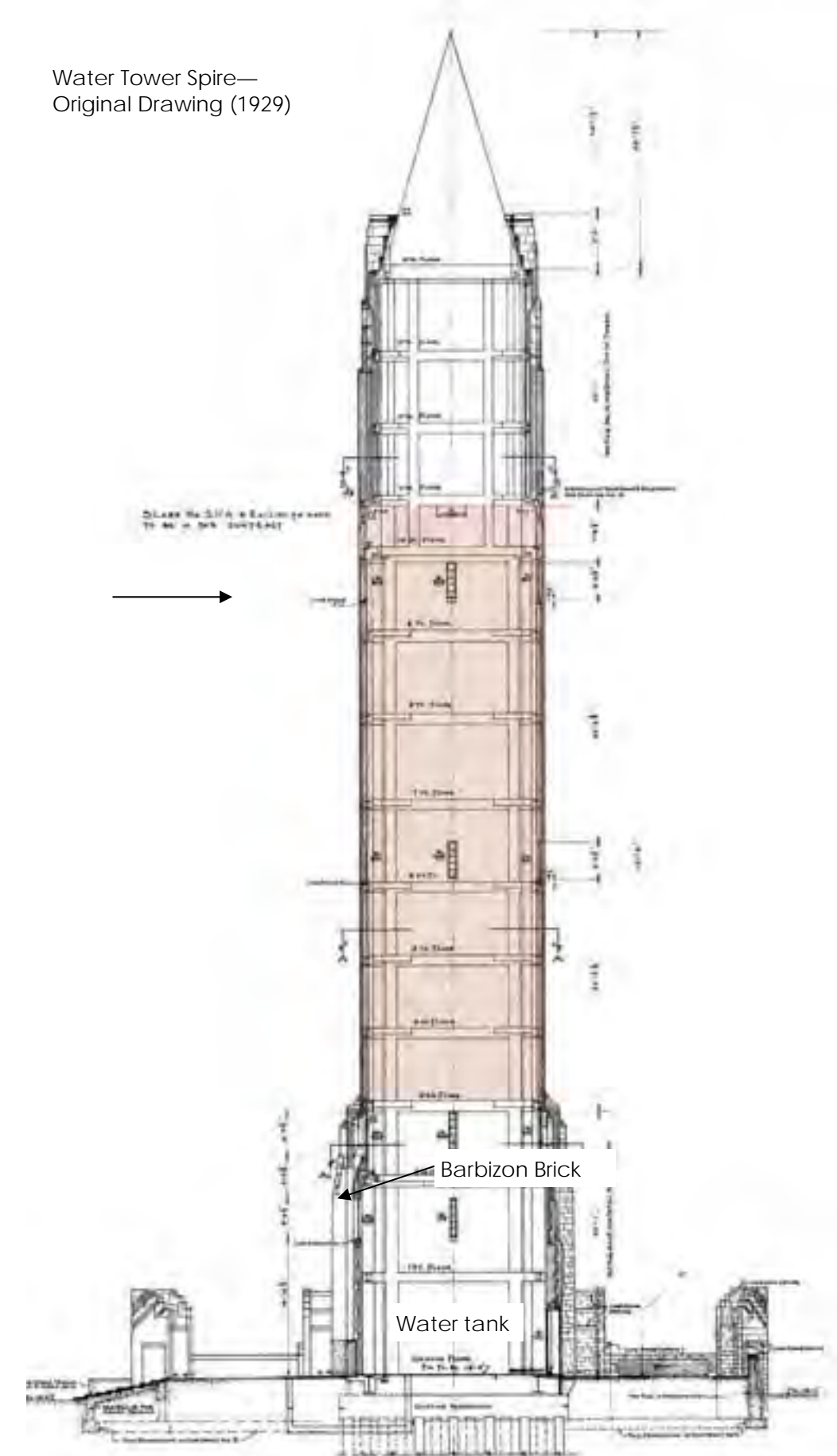

WATER TOWER (1930)

DESCRIPTION

EXTERIOR—BASE

- The base of the Water Tower features Art Deco style trim in a range of characteristic geometric shapes.
- The base is constructed of rock faced sandstone with limestone and granite trim elements.
- The base of the Water Tower is three stories tall and identical of three façades.
- The north façade is unique featuring the entrance to the building.
- A large stone carving of the seal of New York State is centered over a large set of ornate bronze doors. The NY State Seal is over 11' feet tall and carved from limestone. The NY State motto "Excelsior" is carved at the base of the seal. (Excelsior (Latin) translates to "Ever upward" an especially appropriate motto for a tower.)
- A narrow window is set on the center of each façade. The window features five lights set in a narrow column.
- Lights in the masonry base cast light up the Tower at night.



Water Tower Base, 2013

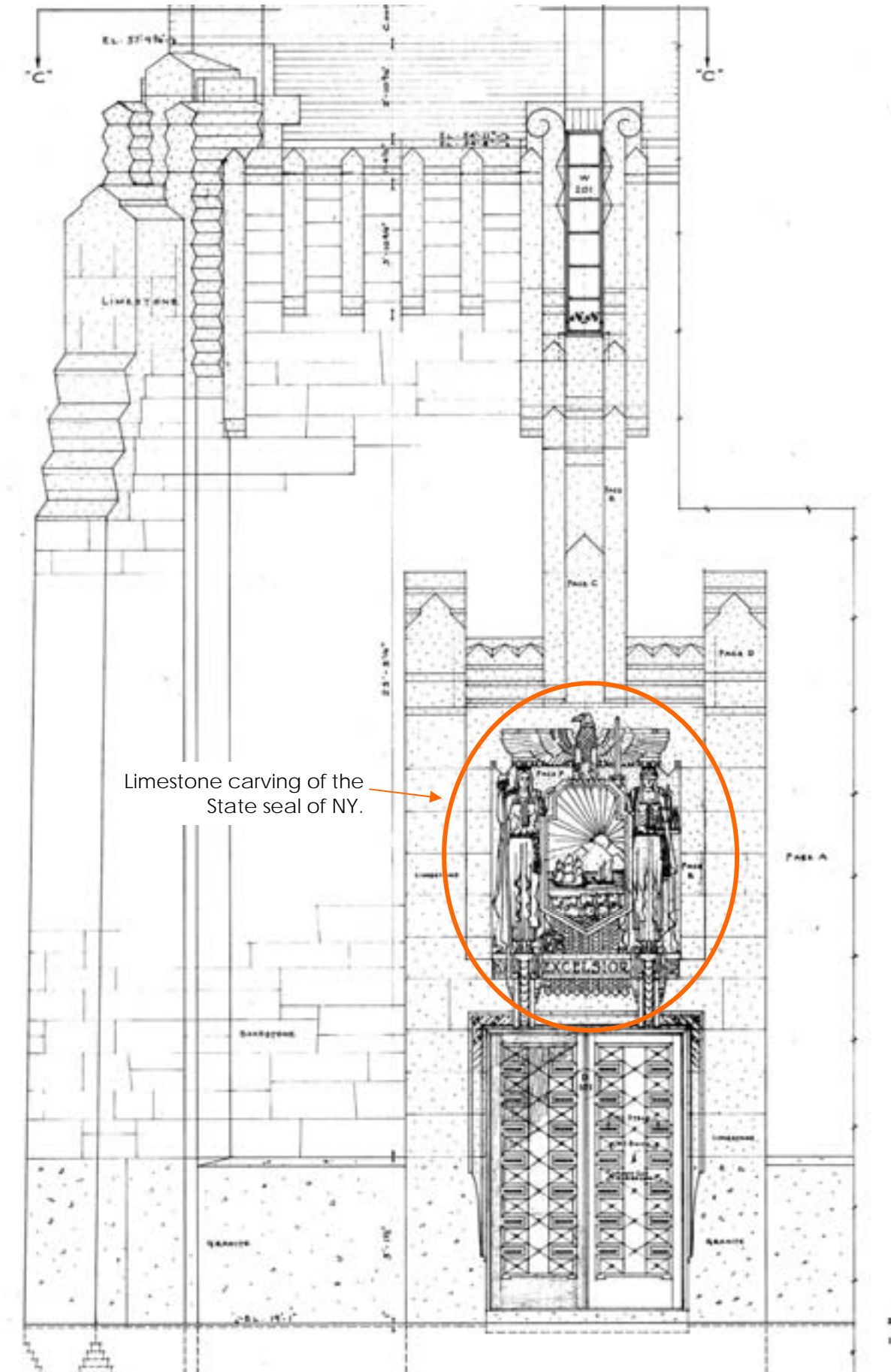

Limestone carving of the State seal of NY.

WATER TOWER (1930)

DESCRIPTION

EXTERIOR—PLAZA

- The Water Tower is composed of three primary components, a central circular plaza and two flanking long rectangular plazas. The east and west ends of the plazas were shaped to form a half circle.
- The central plaza originally featured a formal landscape based around the Water Tower. The Water Tower is set on a raised base at the center of the plaza.
- Wide walkways, set at the compass points, lead from the outer edge of the plaza to the Water Tower.
- Four identical quadrants are created by the walkways. Each quadrant was outlined with low shrubbery along the perimeter and large shaped hedges against the raised base of the Water Tower. Grass filled the area outlined by the shrubbery.
- The hardscape elements of the formal landscape remain but all of the plantings have been lost.
- The two rectangular plazas to the east and west of the central plaza also originally featured formal landscapes.
- Each of the plazas featured a long rectangular reflecting pool that ran almost the entire length of the plaza.
- The outer edge of the plaza was outlined with long shrubbery. Grass filled the space between the shrubbery and the edge of the reflecting pool.
- The long plazas have been completely altered; the plantings and the reflecting pools have been lost.



Water Tower & Reflecting Pool c. 1949



WATER TOWER SUMMARY OF EXISTING CONDITIONS

The Water Tower underwent a major restoration in 2008. The multimillion dollar project included extensive structural repairs to the steel and masonry as well as roof replacement and improvements to the water tank and plumbing. The structure is currently in very good condition.

The landscape of the Water Tower plazas, however, is in very poor condition. All of the plantings relating to the formal landscape plan have been lost. The two reflecting pools have also been lost. The erosion of the original Moses designed formal landscape reduces the integrity of the Water Tower and Jones Beach as a whole.



Water Tower Plaza—2013

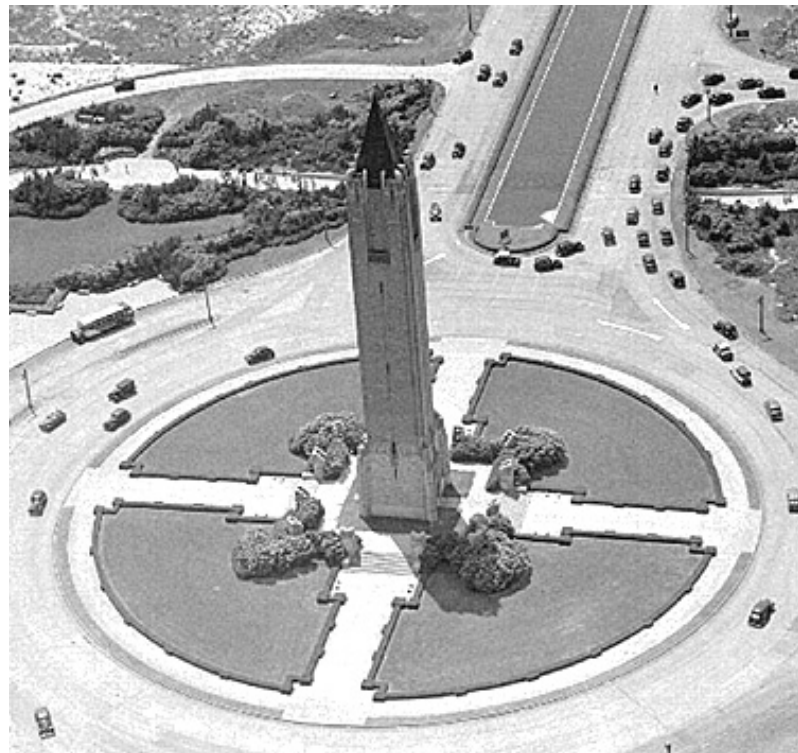

Water Tower Plaza—c. 1940's



Water Tower Plazas—c. 1970s
Note: Loss of formal plantings
and reflecting pools.

WATER TOWER: USE, SIGNIFICANCE & PRESERVATION

USE

Recommendation:

The Water Tower is currently, and has always functioned as the main water source for Jones Beach.

The building has also become the iconic symbol of Jones Beach.

SIGNIFICANCE

The Water Tower is significant:

1. As an important component of the formal Beaux Arts plan of Jones Beach State Park. The specific location reinforces the strong axial component of the Boardwalk.
2. For its architectural design. The building reflected careful thought regarding use, layout, materials and ornamental design. These elements are skillfully used together to create a structure that works individually and as part of the overall park design.

Significant Elements include:

1. **Materials.** The use of specific materials was consistent throughout Jones Beach and helped maintain a sense of unity through the large park. Important materials uses at the Water Tower include Barbizon Brick, buff colored sandstone, limestone and copper trim element. Copper was especially used in the early buildings at Jones Beach (pre-1940)
2. **Design Elements.** Important design elements include:
 - Art Deco style.
 - Symmetry of the building in relation to the central mall.
 - High level of ornamentation on primary elevations.
3. **Function & Design.** The relationship between design and function is significant. The building was designed to transcend its utilitarian purpose, becoming a fundamental part of the greater park design. The building was designed to be the center piece of Jones Beach.
4. **Period of Significance: 1930**

TREATMENT

Recommendations: Rehabilitation

Retention and preservation of Historic Materials

1. The impact of alterations, repairs and even code upgrades should be weighed in terms of their effect on historic fabric. Code requirements specifically the ability to meet health and safety, energy codes and ADA requirements should be addressed without damaging historic spaces, features or finishes.

Repair of Historic Materials and Features

1. When necessary deteriorated fabric should be replaced in kind. While replacing in kind is an option the integrity of the building is tied to its original fabric so the primary goal should be the preservation of historic fabric.

Replacement of Missing Historic Features

1. The formal landscape of the central Water Tower plaza should be restored.
2. The possibility of reinstalling the reflecting pools should be explored.

**ZONE 1: CENTRAL MALL AREA
BOARDWALK**

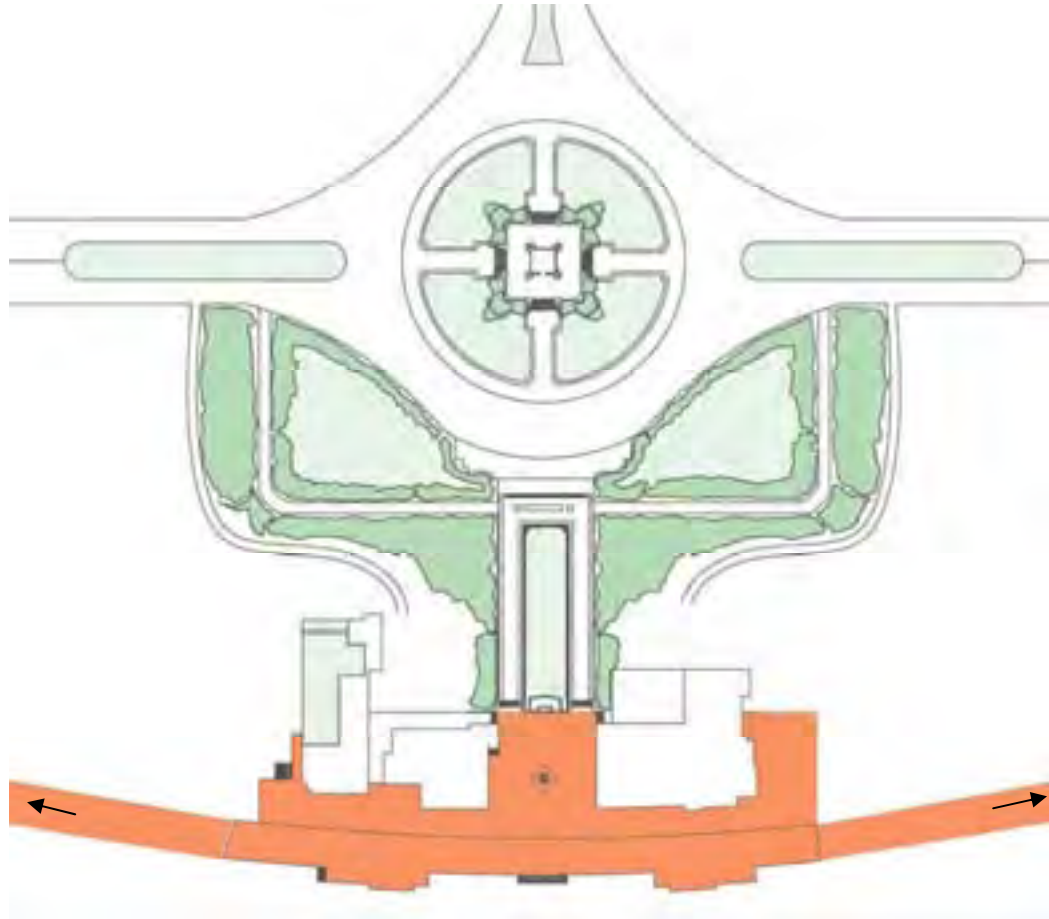

Boardwalk



Boardwalk, 1949

BOARDWALK CHRONOLOGY OF DEVELOPMENT & USE

- The Boardwalk is the pedestrian spine of Jones Beach. It connects all of the public amenities along the south (Atlantic Ocean) elevation of the Park.
- The Boardwalk was constructed in multiple phases; growing as the Park expanded out from the Central Mall.
- Designed in 1929 by:
 - Landscape Architect: Clarence Combs, MLA
 - Engineers: A.E. Howland & W. Earle Andrews
 - LPC President: Robert Moses (Final approval)
- In addition to the boardwalk and railings the Boardwalk included a number of important features including a fire suppression system, shelters & canopies, lighting, water fountains and benches.
- The Boardwalk was designed to maintain the nautical theme of Jones Beach. As originally designed the railing resembled a ship railing: round wood hand rail with aluminum pipe railing below. The other features were also whimsically designed to maintain the nautical theme.



Boardwalk, 2013

BOARDWALK (1930-1951)

CHRONOLOGY OF DEVELOPMENT & USE

- The Boardwalk at Jones Beach was constructed in three phases. The first section of the Boardwalk was developed in conjunction with the Central Mall area. This section of the Boardwalk connected the three major features along beach, the West Bathhouse, the East Bathhouse and the Central Mall.
- After the 'Great Hurricane' of 1938 much of the original section of Boardwalk was re-constructed.
- In 1947-48 the Boardwalk was extended to the east and west. On the east, the boardwalk was extended to Parking Field 6, and on the west it reached Parking Field 2.
- In 1951 the Boardwalk was extended to the west to reach Parking Field 1.
- The Boardwalk at Jones Beach is used year round. Depending on the season dozens to tens of thousands of patrons per day may use the Boardwalk.

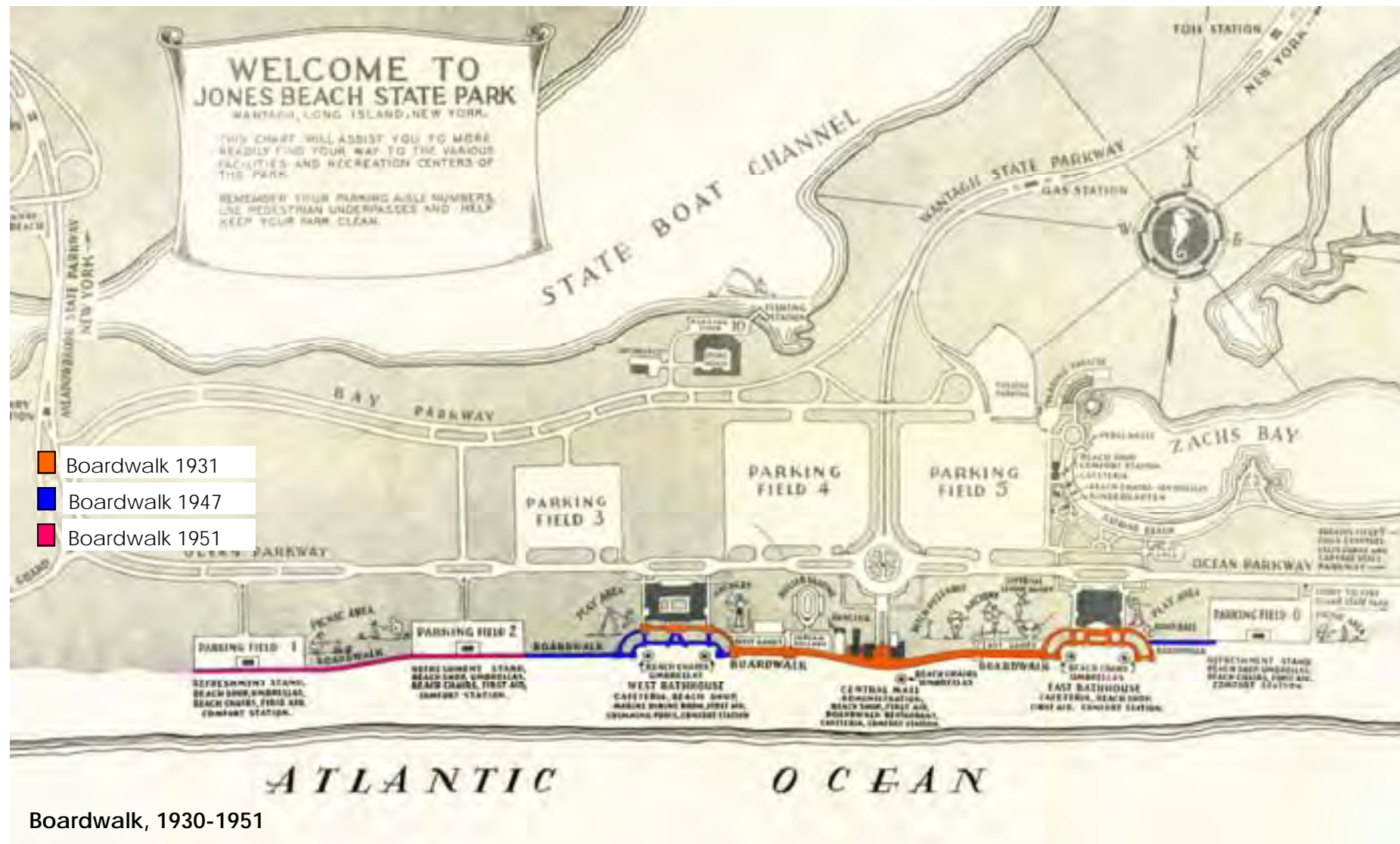

Boardwalk, 1930-1951



BOARDWALK

DESCRIPTION

- The Boardwalk is two (2) miles long and, with the exception of the Central Mall area, 40' wide.
- The wood boards of the Boardwalk are set in a complex pattern. The pattern is based around the main axis of the Central Mall.
- The Boardwalk is divided into triangles around the Flag Pole at the center of the Mall. The planks are set at a different angles within each triangle. Early photographs indicate that the pattern created by the placement of the boards may have been reinforced with wood stain.
- The main east-west section of the Boardwalk also features alternating patterns based around the central axis.
- The Boardwalk also features a number of sheltered pavilions. The shelters project off the main boardwalk toward the beach and are covered with low flat roofs. Canvas awning originally cover the shelters.

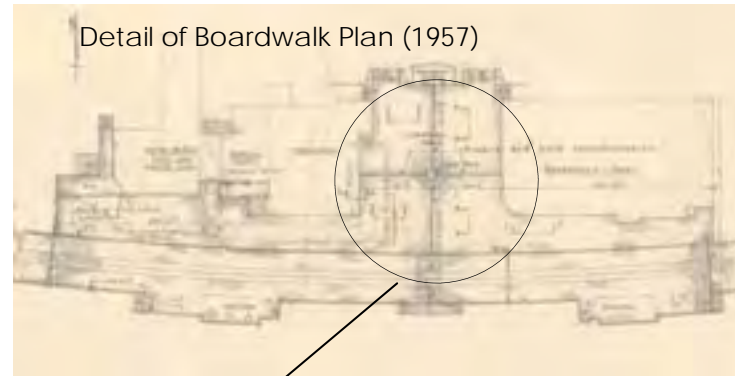

Detail of Boardwalk Plan (1957)

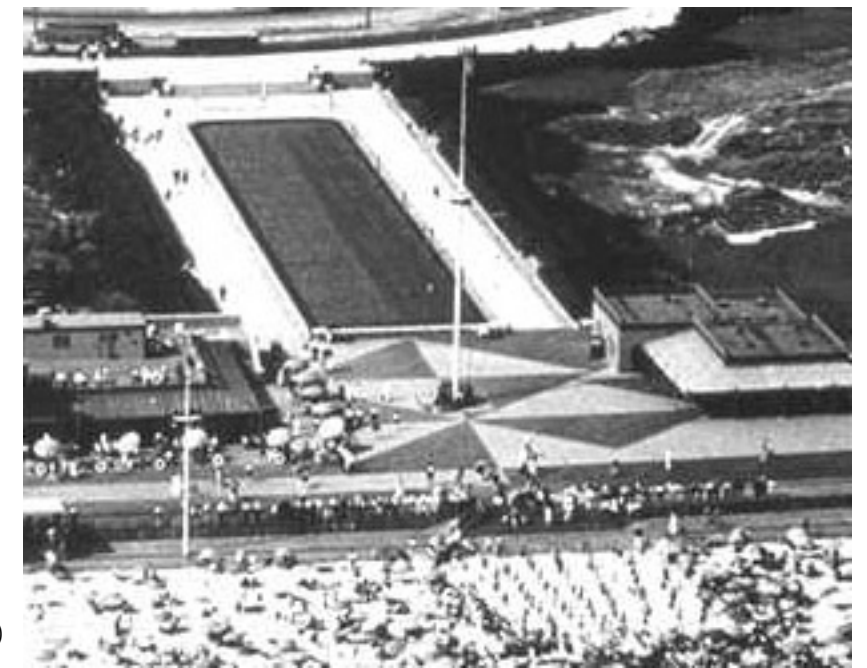

Boardwalk pattern (1932)

Detail of Boardwalk Plan (1957)
Diagonal Lines indicate angle of decking.

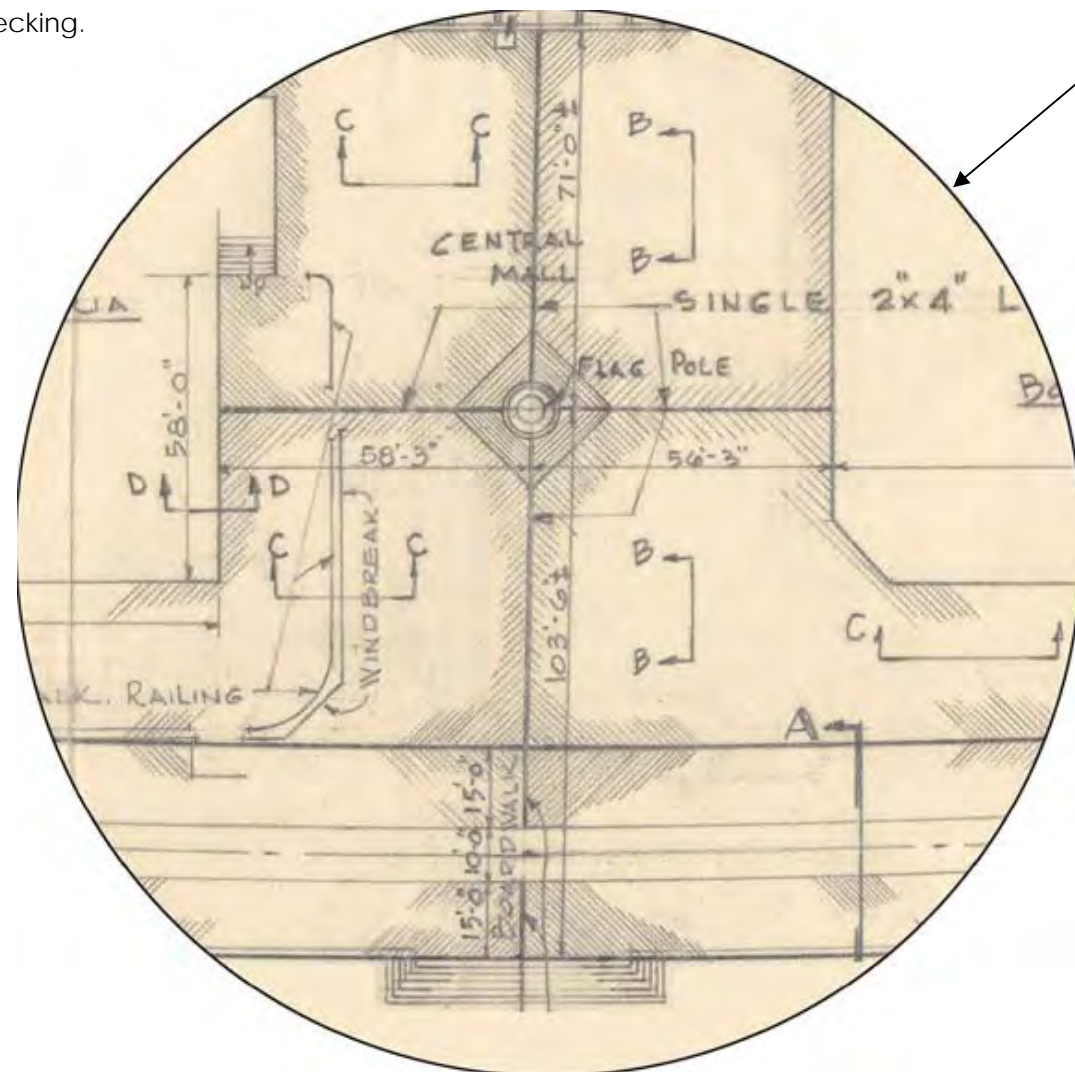

Boardwalk pattern (1949)

Boardwalk shelter

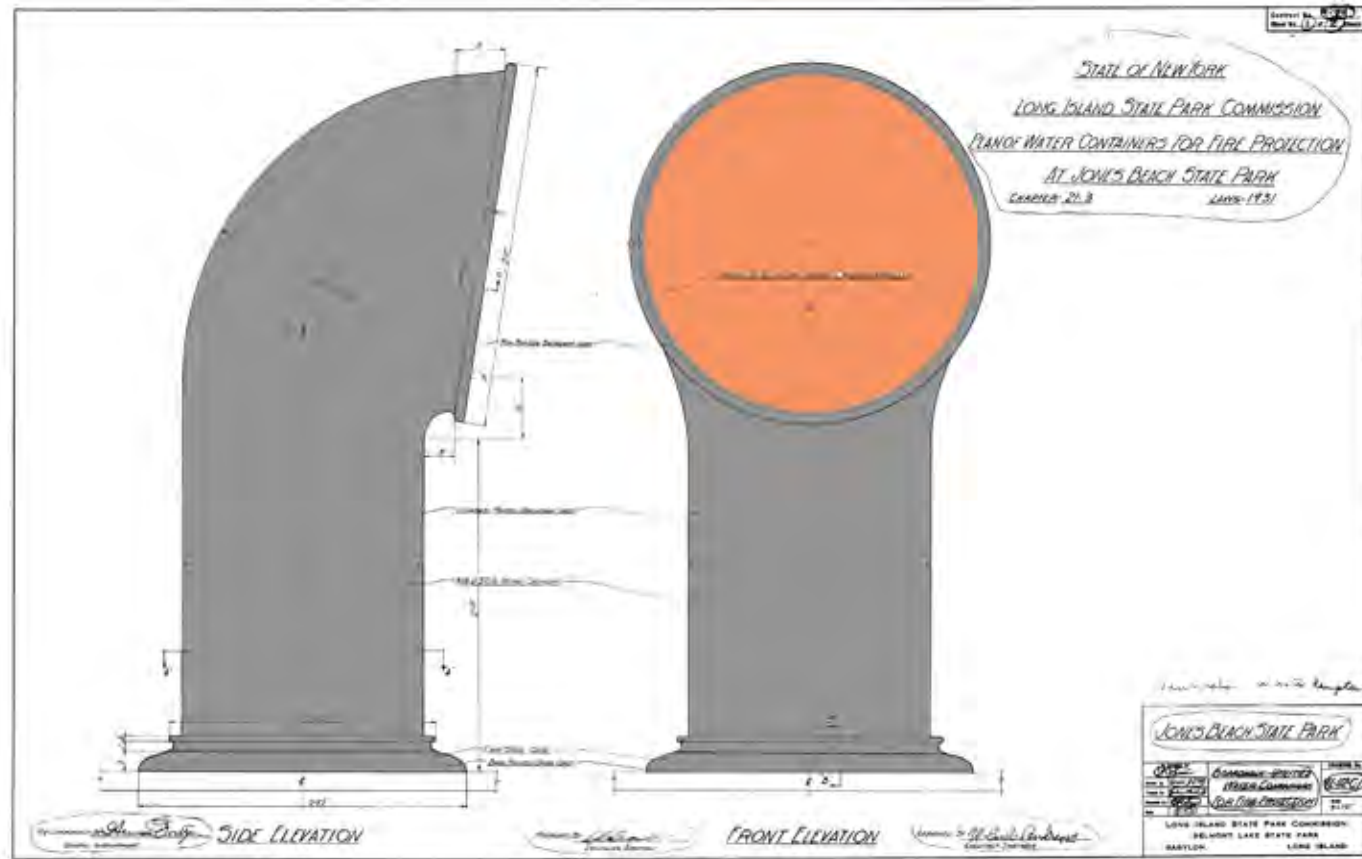

Boardwalk Features: Water Containers for Fire Protection designed as ship funnels.

BOARDWALK (1930-1950's)

DESCRIPTION

- The Boardwalk was defined by a number of key features that were all inspired by the Parks' nautical theme.
 - Fire Suppression System: In the late 19th and early 20th century many boardwalk style amusement/trolley parks were destroyed in very large, public fires (i.e. Dreamland at Coney Island). Jones Beach was designed with a fire suppression system to prevent or respond to the risk. The large funnel shaped containers along the boardwalk were part of this system. The containers were designed to resemble the funnels on the deck of a ship.
 - Lighting: The lighting was designed for the pedestrian level. Caged lamps were hung from a low stanchion with a slight arch at the top.
 - Signage: Signage was also incorporated into the light poles to reduce clutter.
 - Railing: The Boardwalk railing was designed to resemble a period ocean liner railing. The railing originally featured a rounded wood hand-rail supported by cast iron stanchions. 1 1/2" aluminum pipe was used for the lower part of the railing.
 - Life-preservers: Traditional round 'donut' life preservers were secured on the railing and boardwalk shelters.



Boardwalk Fire Suppression System & Light Pole with signage



Boardwalk Railing—note wood hand rail.

BOARDWALK (1930-1950's)

DESCRIPTION

- The Boardwalk was defined by a number of key features inspired by the Parks' nautical theme.
 - Boardwalk Shelters: The shelters featured canvas awning and ship style railings ornamented with life rings. The water fountains in front of the shelter recalled buoys.
 - Flag Pole: The flag pole features an oversized wood railing recalling the railings used around a ship's mast. The flag pole and mast can also support Coast Guard style signal flags.
 - Water Fountains: At least two nautically themed styles of water fountains were installed on the boardwalk. The first resembled a ship's wheel—the wheel had to be turned to activate the spout. The second type of fountain resembled a channel buoy.



Flag pole with signal flags, 1931



Flag pole base, 2013



Boardwalk Shelter, 1936



Buoy style water fountain c. 1940



Ship wheel style water fountain c. 1940

BOARDWALK SUMMARY OF EXISTING CONDITIONS

- As the major pedestrian walkway at Jones Beach the Boardwalk itself (plank walkway) is kept in very good condition. The Boardwalk was heavily damaged by Super Storm Sandy in 2012 but was repaired and ready for the 2013 beach season.
- The character of Boardwalk, however, has been dramatically impacted over time by the loss and replacement of historic features.
- Important features that have been lost include the wood hand rail on the railings, the historic light features, the nautically inspired water fountains and the canvas awnings on the boardwalk shelters. The loss of these features reduced the overall character and unity of the boardwalk and the Park as a whole.
- Fortunately, some features have been retained and adapted for modern use. The fire suppression funnels have been replicated and converted to trash receptacles. The railing and funnels help maintain the character of the boardwalk.

BOARDWALK: USE, SIGNIFICANCE & PRESERVATION

USE

Recommendation:

The Boardwalk is currently, and has always functioned as the main pedestrian walkway at Jones Beach. The boardwalk also links all of the major ocean side facilities.

SIGNIFICANCE

The Boardwalk is significant:

1. As an important component of the formal Beaux Arts plan of Jones Beach State Park. The specific location reinforces the strong axial component of the Boardwalk.
2. For its architectural design. The Boardwalk was skillfully designed by architects, engineers and Robert Moses to unify the park physically and stylistically. The boardwalk elements were designed to maintain the nautical theme of Jones Beach.

Significant Elements include:

1. **Materials.** The use of specific materials was consistent throughout Jones Beach and helped maintain a sense of unity through the large park.
 - The Boardwalk planks were wood, the railing was aluminum with steel stanchions and a wood handrail.
 - Canvas awnings were used on the shelters linking the boardwalk to the buildings and beach umbrellas.
2. **Design Elements.** Important design elements include:
 - Low horizontal character of the boardwalk and shelters.
 - Nautical Style.
 - High level of ornamentation on functional elements including:
 - Fire suppression funnels
 - Water Fountains
 - Railings
 - Flagpole
3. **Period of Significance: 1930-1950's**

TREATMENT

Recommendations: Rehabilitation

Retention and preservation of Historic Materials

1. The impact of alterations, repairs and even code upgrades should be weighed in terms of their effect on historic fabric.

Repair of Historic Materials and Features

1. When necessary deteriorated fabric should be replaced in kind. While replacing in kind is an option, the primary goal should be the preservation of historic fabric.

Replacement of Missing Historic Features

1. The nautical theme should be restored at the Boardwalk. When new or upgraded facilities are required on the boardwalk an effort should be made to maintain and restore the cohesive character of the boardwalk.
 - Signage
 - Railing—wood hand rail
 - Nautical Water Fountains
1. The lighting on the boardwalk should be returned to the pedestrian scale. Efforts should be made to incorporate elements of the original design while still meeting modern illumination and energy efficiency requirements.

**ZONE 1: CENTRAL MALL AREA
CENTRAL MALL PLAZA**

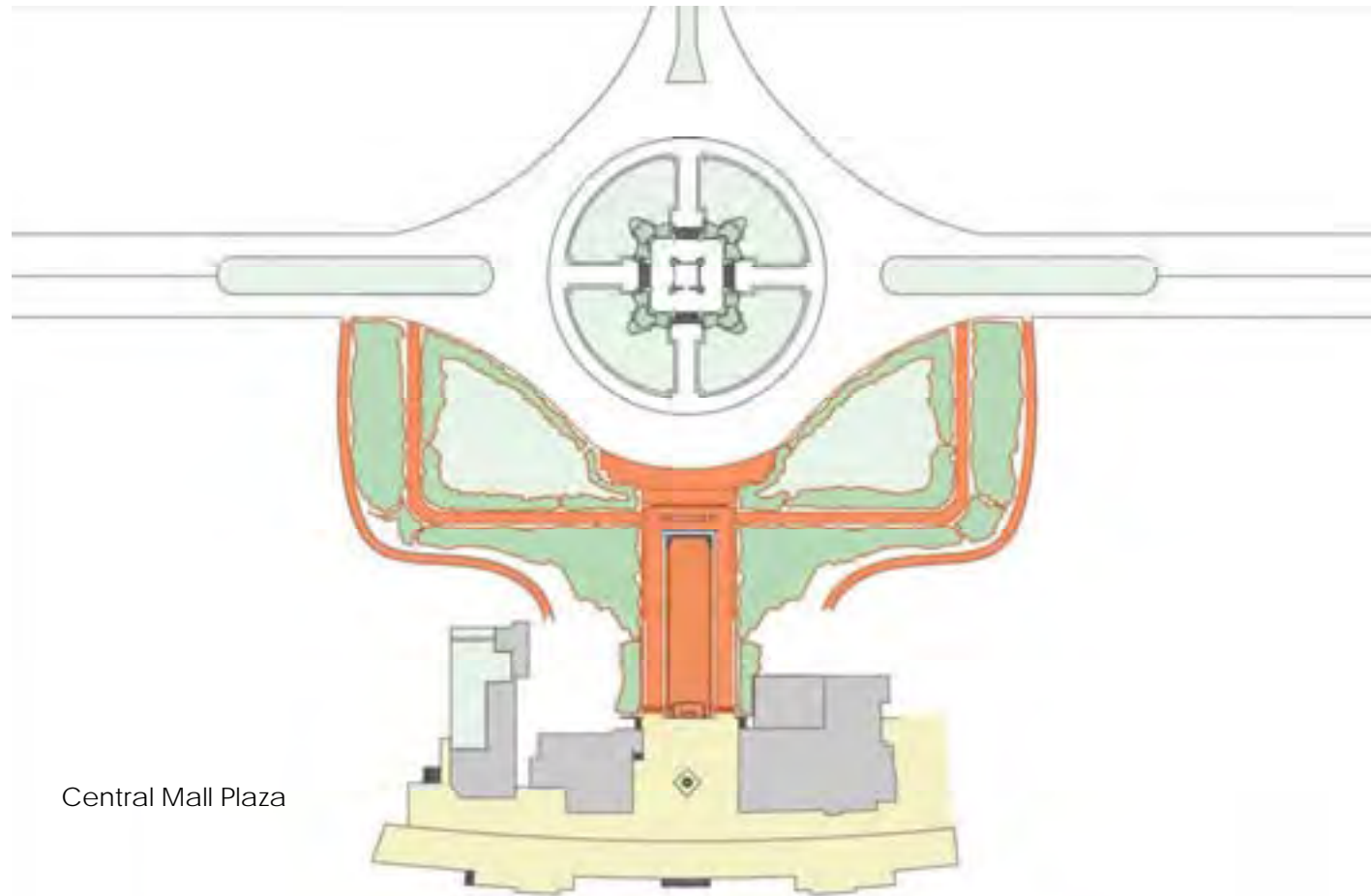

Central Mall Plaza

**CENTRAL MALL PLAZA
CHRONOLOGY OF DEVELOPMENT & USE**

- The Central Mall plaza is the heart of Jones Beach. The Mall includes the main plaza, the traffic plaza, the walkways to the parking fields, the adjacent drives and the surrounding landscape.
- The Mall Plaza and pedestrian underpasses were opened in July of 1931.
- Designed by:
 - Landscape Architect: Clarence C Combs, MLA
 - Engineers: A.E. Howland & W. Earle Andrews
 - LPC President: Robert Moses (Final approval)
- Symmetry is a key component of the design—each walkway, drive and landscape feature mirrored across the center of the Mall plaza.
- Common paving materials link the area including buff colored concrete, flagstone and stone mosaics.
- Landscape features are also used to reinforce the symmetry of the area and clearly define walkways. The landscape was design to allow patrons to emerge from the vast parking areas into a cool, green, plant lined walk leading before arriving at the formally planted main plaza.



Central Mall Plaza, c. 1940's



Central Mall Plaza, 2013



■ Service Drive
 ■ Pedestrian Walkway
 ■ Traffic Plaza
 ■ Main Plaza

CENTRAL MALL PLAZA (1930)

DESCRIPTION

- The Central Mall Plaza is the center of Jones Beach. The main ocean side facilities of the park are organized around the central axis of the mall. Everything is either east or west based on the Central Mall.
- It is important to understand that Jones Beach was designed to be a 'new' type of park for the masses—a safe, clean, & beautiful Park based on European palace grounds and the Olmstead park tradition. The Central Mall clearly represents this design aesthetic. Layout, landscaping and hardscape were used to shape the visitors impressions and experience.
- The hardscape elements and landscape were used to draw patrons from the vast parking fields to the beach in a carefully orchestrated way. Plantings were used to define views and control vistas as well as define the character of the Park.
- The hardscape features include the service drives, the pedestrian walkways, the main plaza and plaza at the traffic circle. The Main Plaza also included a water feature at the south end of the plaza and small seating areas tucked into the landscaping. These features are defined by a hierarchy of material, style and ornamentation. Flagstone and natural stone mosaics were used to denote significant spaces while concrete was used in more utilitarian and high traffic areas. Every element, even the light fixtures were carefully designed to contribute to design and the overall theme of the Park.
- The areas between walkways and driveways were defined by a formal landscape plan.

■ Concrete
■ Flagstone
■ Mosaics
■ Grass
■ Shrubbery
■ Light Poles

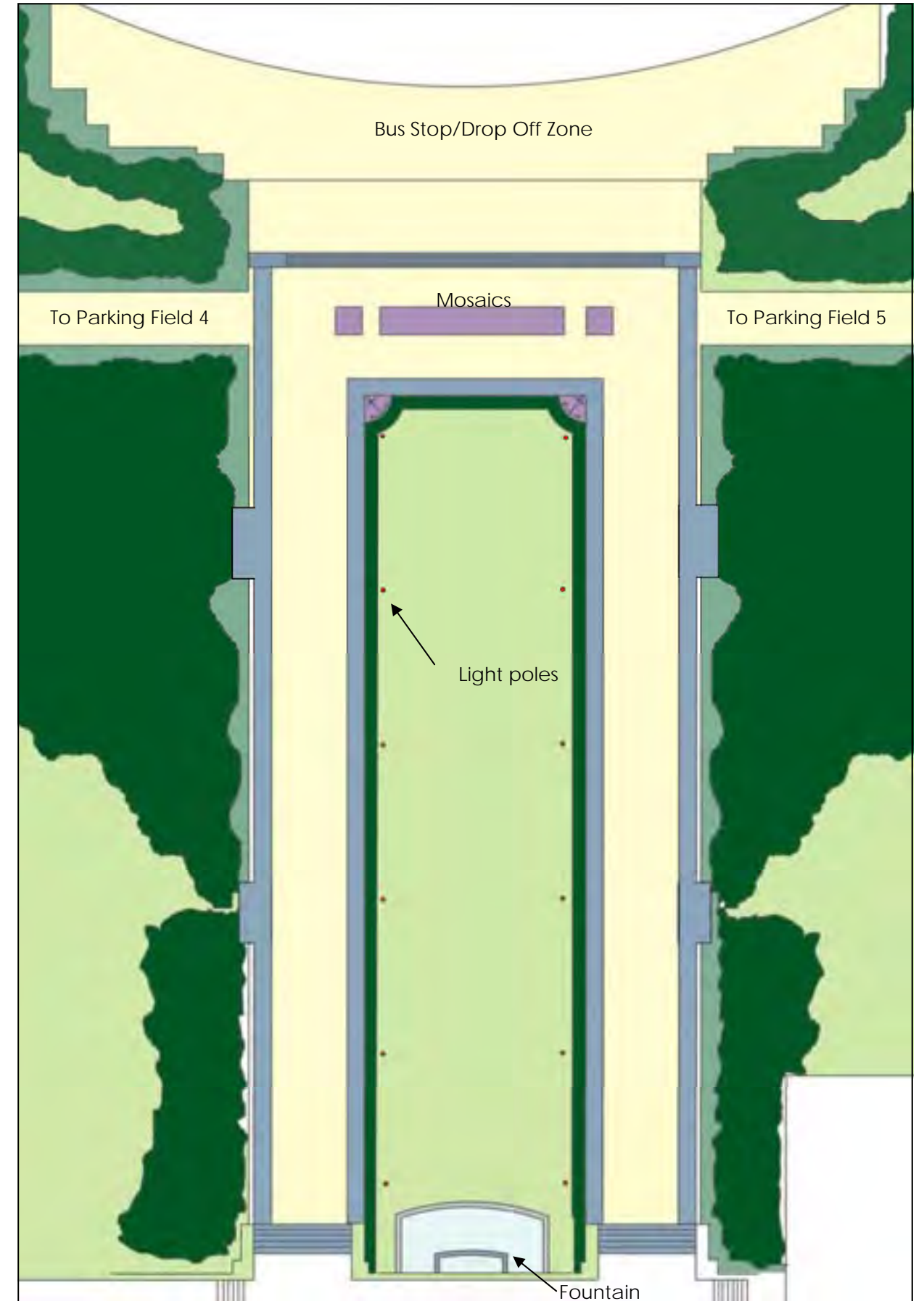

CENTRAL MALL PLAZA
DESCRIPTION—LANDSCAPE

- The Central Mall was defined by a formal landscape plan. The landscape plan was based on a modern interpretation of the Renaissance Parterre garden style.
- Parterre is a formal garden style based on symmetrical patterns, closely cropped hedges and clearly defined spaces. Traditionally paths were used to separate and complement the planting beds. Other characteristic features include the use of different species of shrubs with different colors, shapes and leaf style and the limited use of flowering plants.
- The original Mall design featured a variety of hedges and shrubs that were symmetrically planted along the main axis of the Central Mall. The hedges were most closely cropped and shaped at the center of the mall, growing in height, wildness and depth of color as they extended to the east and west.
- This pattern was continued along all of the garden paths and along the traffic plaza at the head of the Mall.
- Flowers were only used in small closely defined areas at the traffic plaza.
- While gravel may have been traditionally used in a Parterre garden, the designers of Jones Beach substituted concrete and slate. Modern materials were much better suited to the harsh ocean environment and traffic from millions of patrons.



CENTRAL MALL
DESCRIPTION—HARDSCAPE

- The hardscape features were an important part of the formal garden plan.
- The main pathways were constructed of concrete. In more significant areas the concrete was outlined with flagstone. Flagstone was used to line both sides of the Central Mall plaza, the stairs and for the recessed seating areas along the plaza.
- At the north end of the plaza, mosaics were set into the bluestone boarder. The mosaics reinforced the nautical theme of the Park depicting stylized anchors and ropes. The mosaics were constricted of cut natural stone (red & blue sandstone) set in a mortar bed.
- A large three part mosaic was also located at the north end of the Plaza at the intersection of the pedestrian walkways, the traffic plaza and main plaza. The large central mosaic featured a map of Long Island with the parks highlighted. The map was flanked by two smaller mosaics of sea creatures including lobsters and shells. The mosaics were constructed on natural stone (blue, red, purple and green sandstone)
- The Central Mall also featured a fountain at the south end. Water cascaded from a outlet in the south wall, spilling first into a small raised pool and then a larger pool.



Central Mall—Bluestone paving 1930's



Central Mall—Mosaic, 2013



Central Mall—Fountain (1960's)



Central Mall—Mosaic, 2013

CENTRAL MALL PLAZA
DESCRIPTION—SIGNAGE & LIGHTING

- The Central Mall also originally featured distinctive lighting and signage.
- The main plaza featured a dozen Art Deco inspired lanterns. The bronze lanterns had frosted glass, glass 'fins' and a central light source. Each lantern featured a single 400 candle bulb (550+/- Watt) and a metal reflector at the top of the lamp. The light poles were 8'9" high and the lanterns were 3'2" high. The Art Deco 'fins' on the lanterns helped to direct the light.
- The Central Mall lamps were designed by LIPC staff in 1931. Drawings approved by W. Earle Andrews, AIA.
- Jones Beach featured a unified sign system along the Boardwalk and Central Mall. Metal signs were hung from square wood posts. The signs featured a variety of whimsical character and messages on the top of the sign rail with a metal plaque below. Amenities and directions were listed on the plaque.



Original Art Deco Light fixture. This fixture is part of the Jones Beach Castles in the Sand Exhibit at the East Bathhouse. 2013

Lantern fins.



Reproduction Sign at Central Mall, 2013

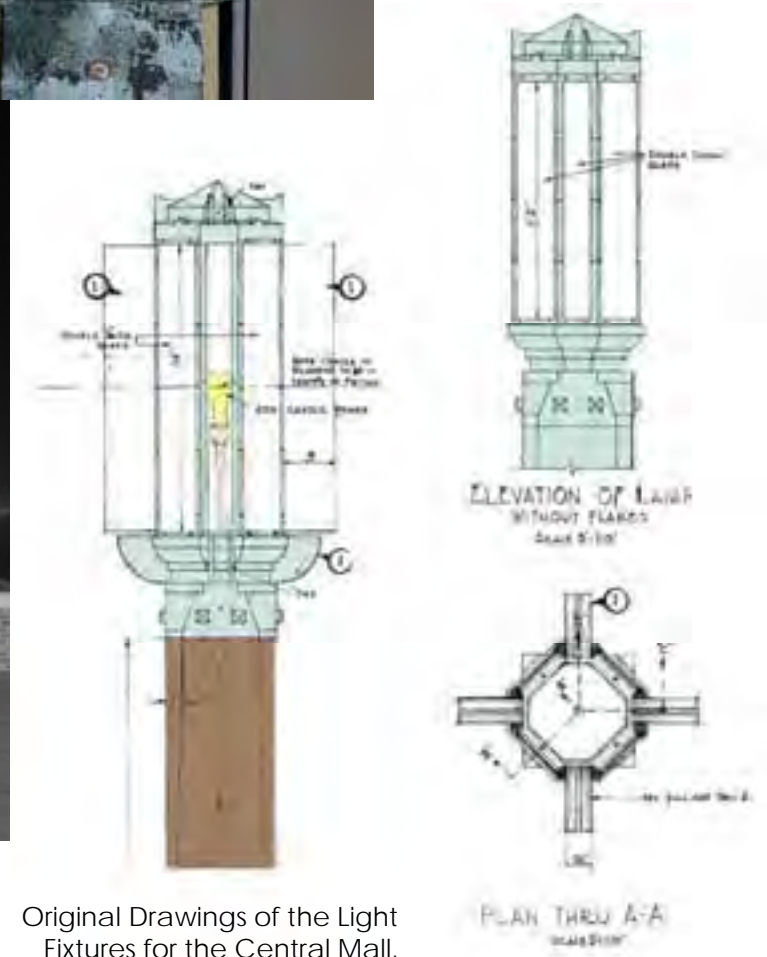

Original Drawings of the Light Fixtures for the Central Mall.

CENTRAL MALL PLAZA SUMMARY OF EXISTING CONDITIONS

The Central Mall is one of the most seriously eroded sections of the Park. Time, deterioration and Super Storm Sandy have greatly diminished the character of the Mall.

Since the Central Mall is the heart of Jones Beach and the main entrance for millions of visitors, the erosion of this area diminishes the character and integrity of Jones Beach as a whole.

Landscape: The original landscape that flourished from the 1930's through the 1960's has degraded to the point that the original plan is barely recognizable. The majority of the shrubbery is lost, dead or overgrown. The loss of the boundaries created by the planting has resulted in the melding of spaces and pedestrian created of short cuts that further undermine the space.

Hardscape: Much of the original hardscape features are still intact. Unfortunately, the mosaics have been greatly undermined by heavy foot traffic and environmental conditions. The mosaics are spalled, cracked and are missing significant pieces. Note: Funding for the restoration of the mosaics was allocated in the 2013 budget. The fountain at the south end of the Mall is also in poor condition. The fountain has been converted into a planting bed.

The Art Deco bronze lanterns along the Central Mall have also been lost. The replacements do not capture the detail or character of the original fixtures.



Loss of formal garden plan.



Deterioration of Central Mall Mosaics.



Original fountain converted into a planting bed.



Significant Erosion of Central Mall Plaza

Short-cut across Central Mall.

CENTRAL MALL PLAZA: USE, SIGNIFICANCE & PRESERVATION

USE

Recommendation:

The Central Mall Plaza is currently, and has always functioned as the main pedestrian entrance to Jones Beach. The original layout, landscape, hardscape and design details were carefully crafted to define the visitors impressions and experience.

SIGNIFICANCE

The Central Mall is significant:

1. As an important component of the formal Beaux Arts plan of Jones Beach State Park. The specific location reinforces the strong axial component of the Boardwalk.
2. For its landscape design. The landscape reflected careful thought regarding use, layout, materials and ornamental design.

Significant Elements include:

1. **Hardscape:** The use of specific materials was consistent throughout Jones Beach and helped maintain a sense of unity through the large park. Important materials used include buff colored concrete, flagstone, slate and cast stone.
2. **Landscape:** The landscape was a formally designed to create defined spaces and a specific atmosphere. Plantings were used to direct crowds, create vistas and establish a sense of arrival.
3. **Design Elements.** Important design elements include:
 - Art Deco style Lanterns.
 - Water Fountain at the south end of the mall.
 - Slate mosaics.
 - Symmetry of the hardscape & landscape features.
4. **Function & Design.** The relationship between design and function is significant. The landscape was designed to transcend its basic purpose; channeling millions of visitors to the beach, becoming a fundamental part of the greater park design.
5. **Period of Significance: 1930**

TREATMENT

Recommendations: Rehabilitation

Retention and preservation of Historic Materials

1. The impact of alterations & repairs should be weighed in terms of their effect on historic fabric. Code requirements specifically the ability to meet health and safety, energy codes and ADA requirements should be addressed without damaging historic spaces, features or finishes.

Repair of Historic Materials and Features

1. When necessary deteriorated fabric should be replaced in kind. While replacing in kind is an option the integrity of the building is tied to its original fabric so the primary goal should be the preservation of historic fabric.

Replacement of Missing Historic Features

1. The formal landscape of the Central Mall should be restored.
 - Landscape: The loss of the formally designed landscape greatly diminishes the integrity and character of Jones Beach. Alterations to original plant section should be considered to allow plantings to better survive in the harsh ocean environment and account for reductions in staff. A number of species of plants are available that will meet these requirements while still achieving the formal Parterre aesthetic.
 - Design Elements: Water Fountain, Art Deco Lanterns, signage and the plaza mosaics.

**ZONE 1: CENTRAL MALL AREA
WEST MALL BUILDING**

East Mall Building, 1931-1964

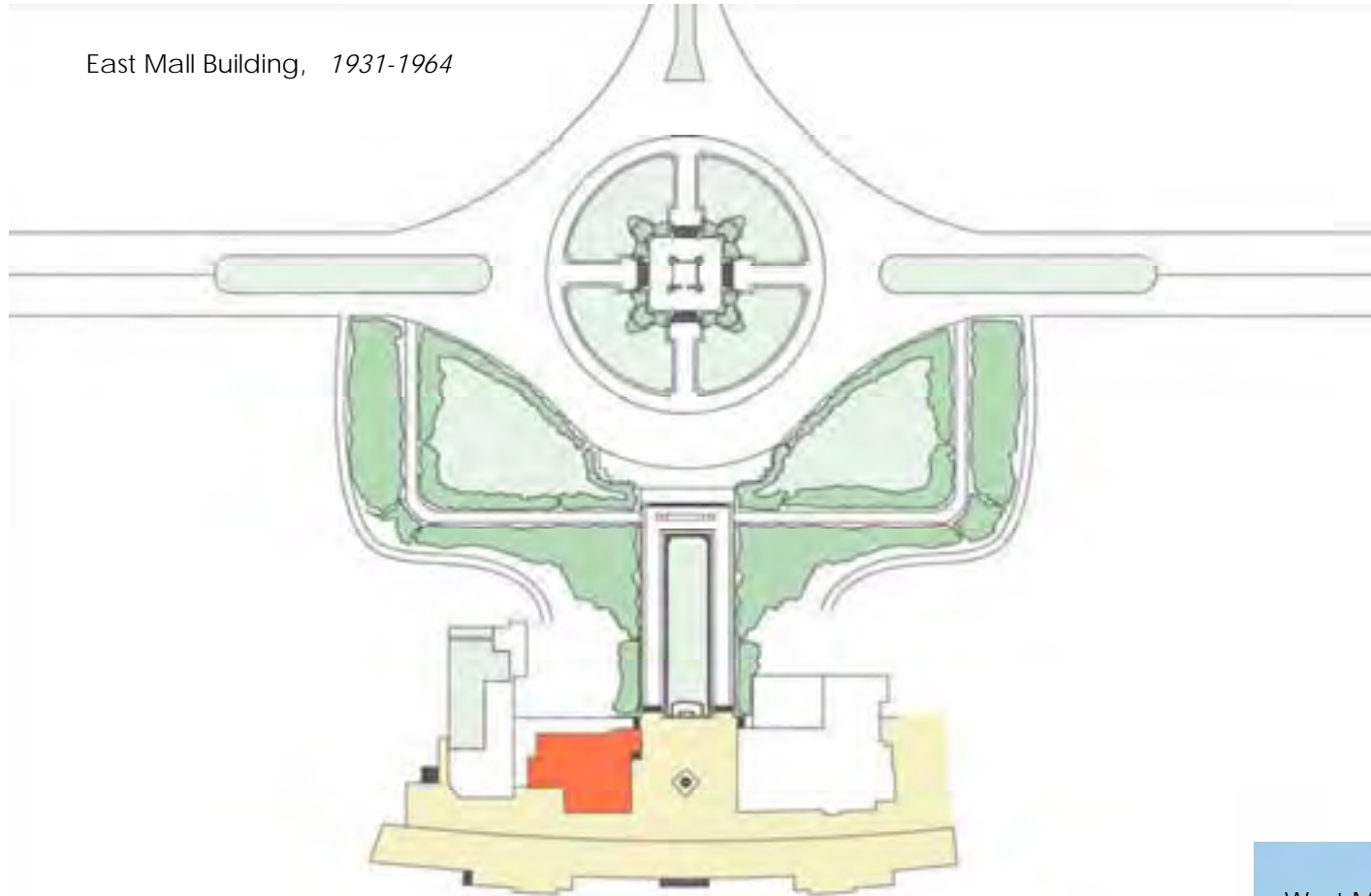

West Mall Building, 1931



**WEST MALL BUILDING
CHRONOLOGY OF DEVELOPMENT & USE**

- The West Mall Building was the first major building completed at the Boardwalk & Central Mall. The building was originally describes as a “Comfort Station & Refreshment Stand”.
- The West Mall Building was designed by Herbert Magoon, AIA in 1930-1931.
- The drawings were approved & signed by Architect/Engineer W. Earle Andrews.
- The building was originally approximately 15,000 sq ft including a 6000 sq ft roof patio. The building also featured a small boardwalk level patio that wrapped around the southeast corner of the building.
- In 1938, the building under went a major reconstruction. Significant changes were made to the exterior and interior of the building.
- In 1950 additional changes were made including the addition of boardwalk canopy and a clock on the south façade of the tower.
- In 1961 more alterations occurred: a glass solarium was installed on the roof patio and a wood and glass screen was installed to enclose the boardwalk patio.
- Later addition include a bubble top canopy over the boardwalk patio and the wood and glass boardwalk screen was replaced with a substantial metal and glass screen.

West Mall Building, 2013



West Mall Building, 1930-31
South Elevation

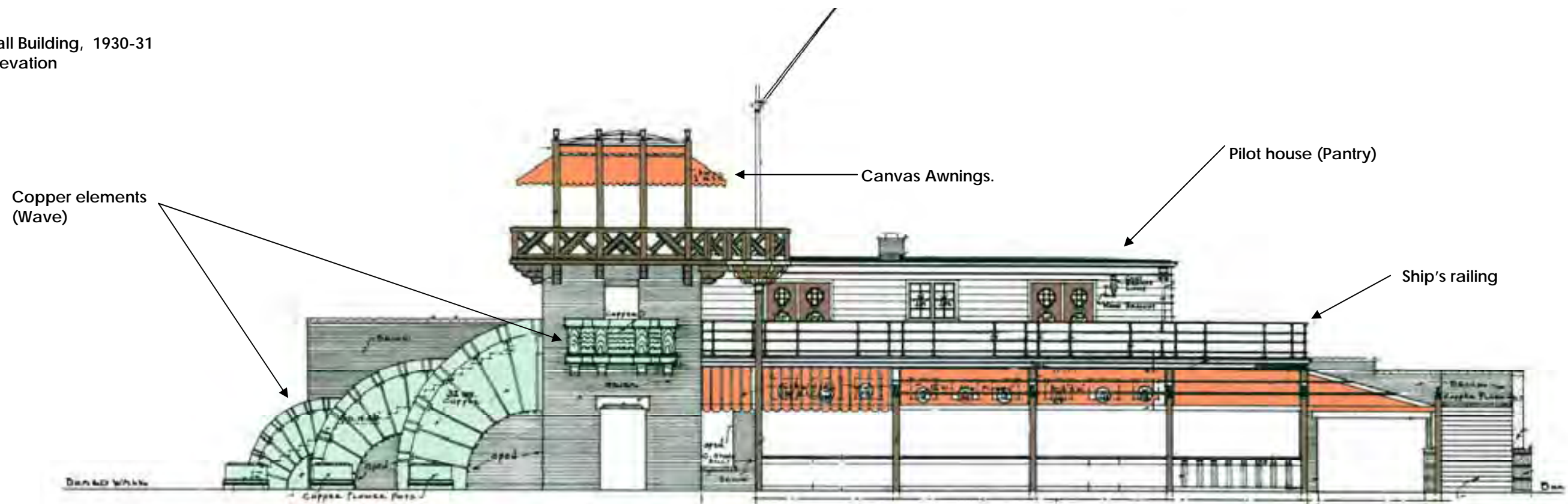

WEST MALL BUILDING (1930)

DESCRIPTION

EXTERIOR

- The West Mall Building was designed to respond to the Central Mall and Boardwalk. The building was also designed to be a part of the larger Jones Beach design aesthetic. The building featured primary facades on beach, boardwalk and Central Mall elevations.
- As with many of the buildings at Jones Beach a nautical theme was used to connect the building and add a whimsical feel to the Park. The building itself resembles a ship with a railing, pilot house and lookout tower.
- The south façade featured an exterior stair to the tower and roof level. The stairs featured a dramatic railing of copper sheet metal designed to resemble cascading waves.
- The south elevation also featured a copper balcony on the central tower window. The balcony was also clad in copper. The overall shape of the balcony is wave-like and the sheet metal is stamped with a wave pattern.
- The exterior doors (roof level and boardwalk) also featured porthole windows.
- The roof terrace featured a wood and pipe railing that recalled a ship's railing. The railing is even accented with preservers at regular intervals (life-rings).
- The tower originally featured a wrap around wood viewing terrace capped by a fabric awning.
- The southeast corner of the building also featured a wrap around covered patio with fabric awnings.
- The building was constructed on Barbizon Brick and Ohio sandstone with significant wood and copper trim elements.
- The small roof top building (pilot house) was wood clapboard with a natural weathered finish. The north elevation of the building was also natural clapboard.

West Mall Building, 1930-31
East Elevation—Detail

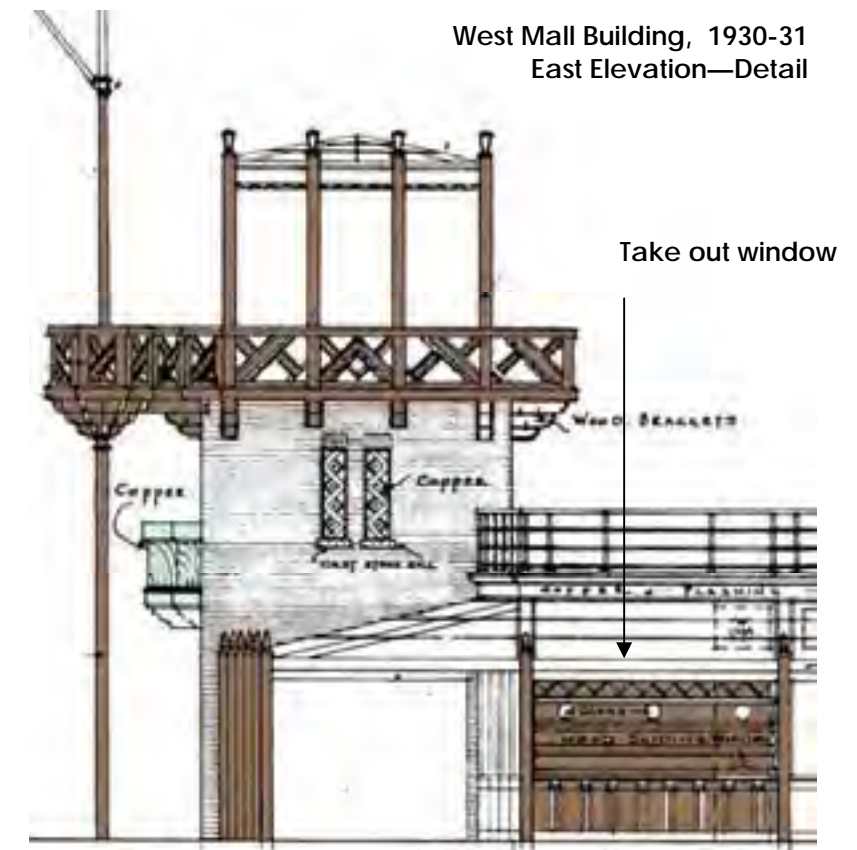

WEST MALL BUILDING (1930)
CHRONOLOGY OF DEVELOPMENT & USE

- The West Mall Building was built to provide café style dining at the Central Mall. 'Take out' windows lined the south and east walls of the building. A small sit down café with table service was centered in the building.
- The seating for the take out windows was located outdoors within a railed in section of the boardwalk along the south and east corners of the building. Additional seating was provided on the roof top terrace. The roof terrace was accessed by the public from three locations: a spiral stair in the tower, a exterior stair on the south elevation and exterior stair on the east elevation.
- Restrooms were constructed on the west and north elevations of the building. The women's restroom featured a lobby and 'mothers room'.
- The building also was designed to serve as a beach/boardwalk viewing area. The crows nest in the tower and the roof deck provided a excellent views of the boardwalk, beach and Central Mall.

West Mall Building—Boardwalk Level

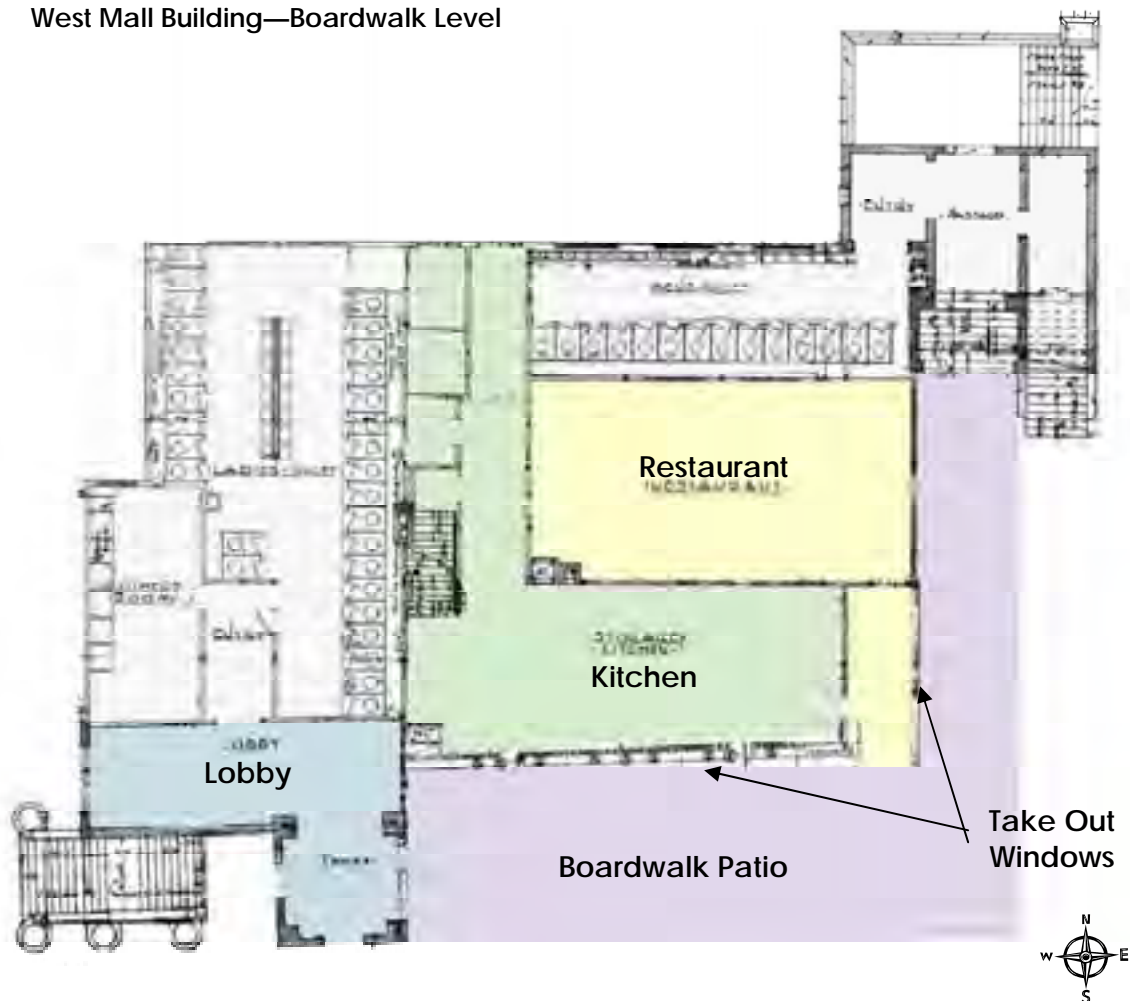

West Mall Building—Roof Top Level

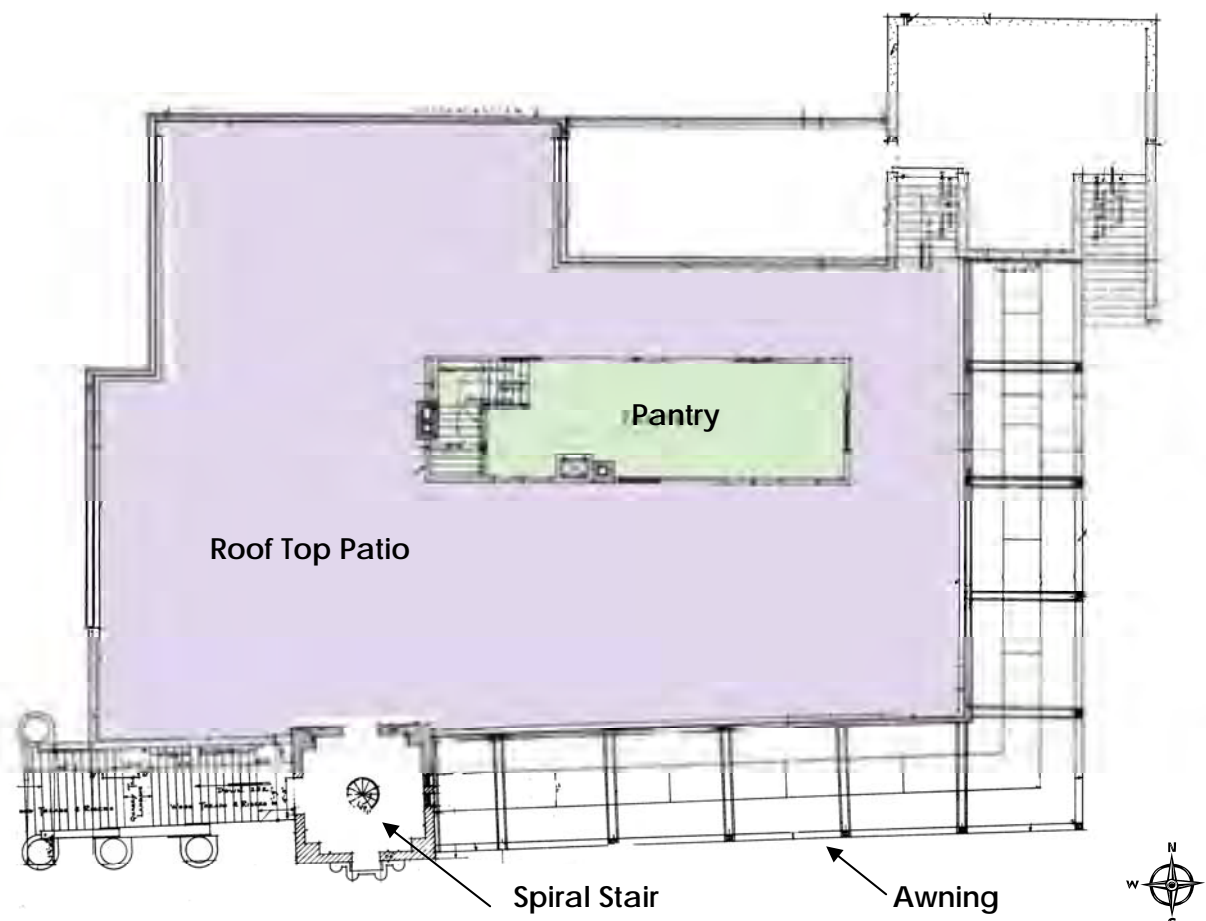

West Mall Building c. 1931 (Green=Staff, Blue=Lobby, Yellow=Restaurant, Grey=Restroom, Purple=Patio)

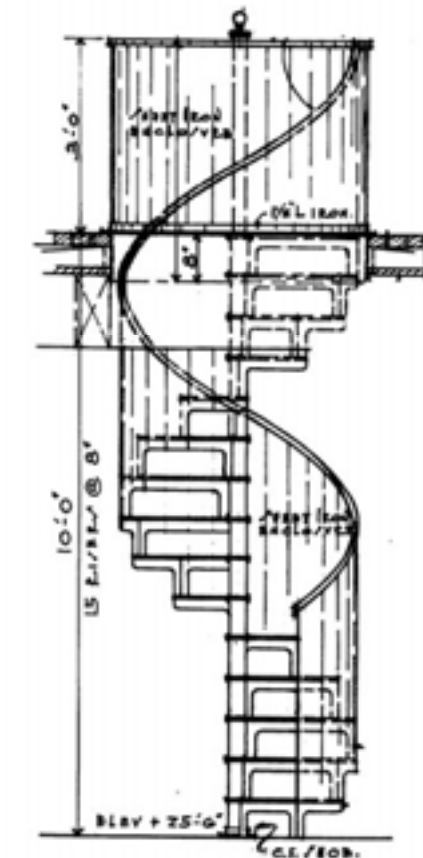
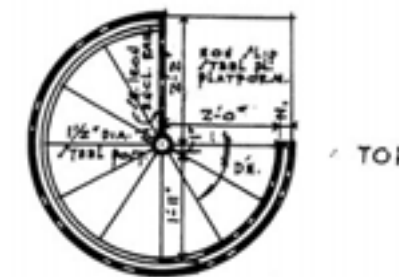

ELEVATION

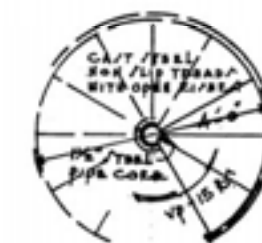

SPIRAL STAIRS
 SCALE: 1/2"=1'-0"

West Mall Building, 1930-1934
South Elevation

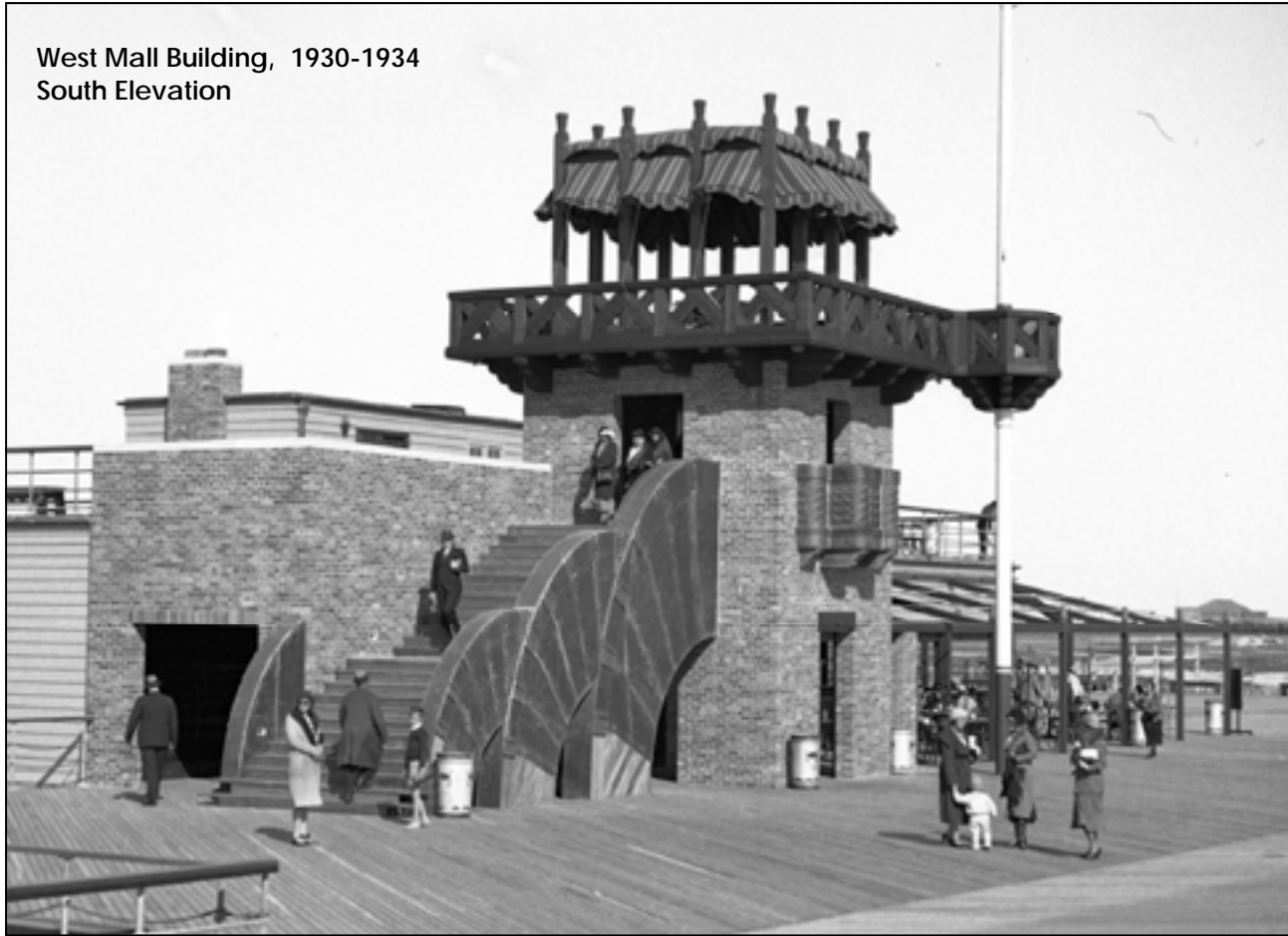

West Mall Building, 1938
South Elevation



WEST MALL BUILDING ALTERATIONS— (1938)
EXTERIOR

- Major alterations were undertaken at the West Mall Building in 1938. These alterations were performed in response to the construction of the East Mall Building (1935) and to better accommodate the volume of patrons at the Central Mall area.
- The West Mall Building was altered to stylistically complement the East Mall Building. Major exterior changes include the redesign of the tower, the removal of the exterior stair, the partial enclosure of the patio and the expansion of the outdoor dining area.
- The wood crows nest that originally topped the masonry tower was removed and replaced with a simple masonry cap that closely match the planned tower on East Mall Building.
- The area below the canvas awnings at the southeast corner of the building was enclosed with wood and glass doors. The original finial capped posts were retained.
- A pipe railing mimicking the roof railing (was installed along the southeast corner of the building to designate an outdoor seating area.
- Additional architectural changes (exterior) include the modification of door and window openings. The stair opening at the top of the tower was converted into a masonry window with a wood grille and four masonry grilles were added along the south façade of the building (former stair location).
- The copper clad grille on the east façade of the tower was replaced with a masonry grille matching those installed on the rest of the building.
- The flag pole that had been attached to the West Mall Building was re-located to the center of the plaza between the East and West Mall buildings.

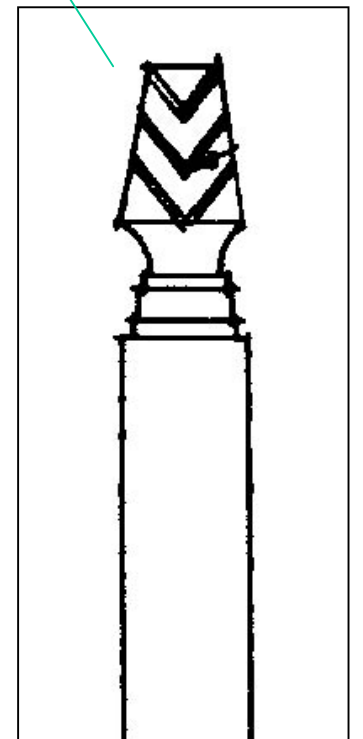

Finial Capped Post

WEST MALL BUILDING (1938)
INTERIOR ALTERATIONS

- The interior of the building was significantly remodeled in 1938. The exterior 'take out' windows were removed as was the interior table service. The kitchen and service areas were flipped allowing for easier egress from the new open cafeteria to the outdoor seating areas. Service stations were installed along two long counters on the west and north elevations.
- The cafeteria served traditional period beach offerings including beer, coffee, soda, oysters, frankfurters, hamburgers and custard.
- The new cafeteria design featured a 'modern' streamlined appearance. The walls, counters and cabinets were all pre-fabricated Monel. Monel was a popular early 20th century metal composed of nickel and copper that was very durable, stronger than steel and could be molded into many shapes.
- Cafeteria offerings were called out on porcelain signs set over the service counters into the Monel clad walls.
- The nautical theme was continued with aquatic murals painted on the walls (non-Monel).
- The outdoor seating area wrapped around the east and south sides of the building. Additional seating was available on the roof terrace.

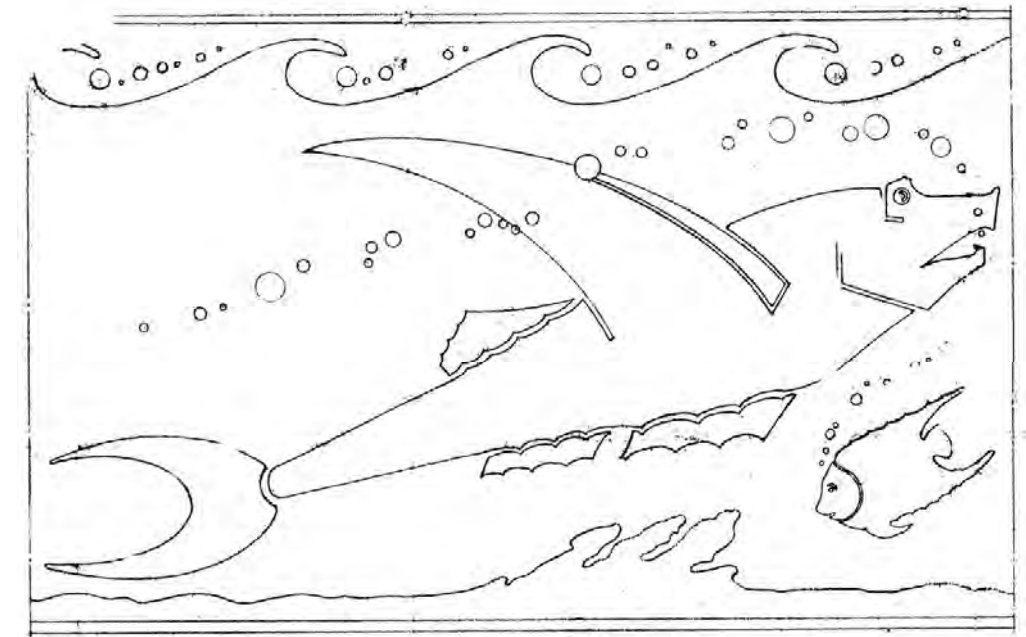

• BACK WALL FISH MOTIF •
 TWO COLORS + BASE COLOR
 FULL SIZE

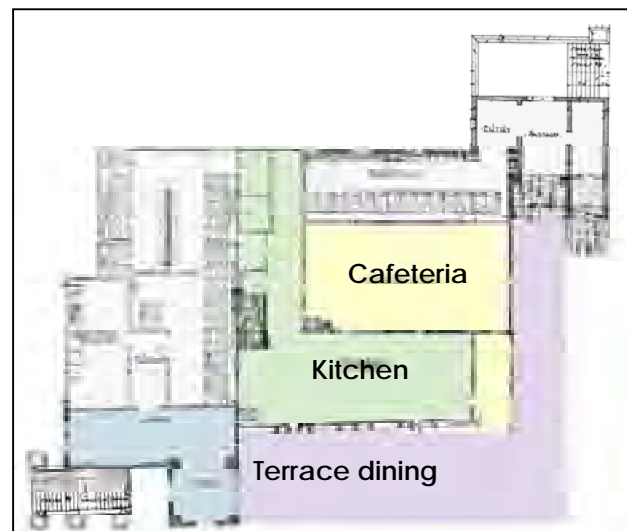

West Mall Interior 1930-1937

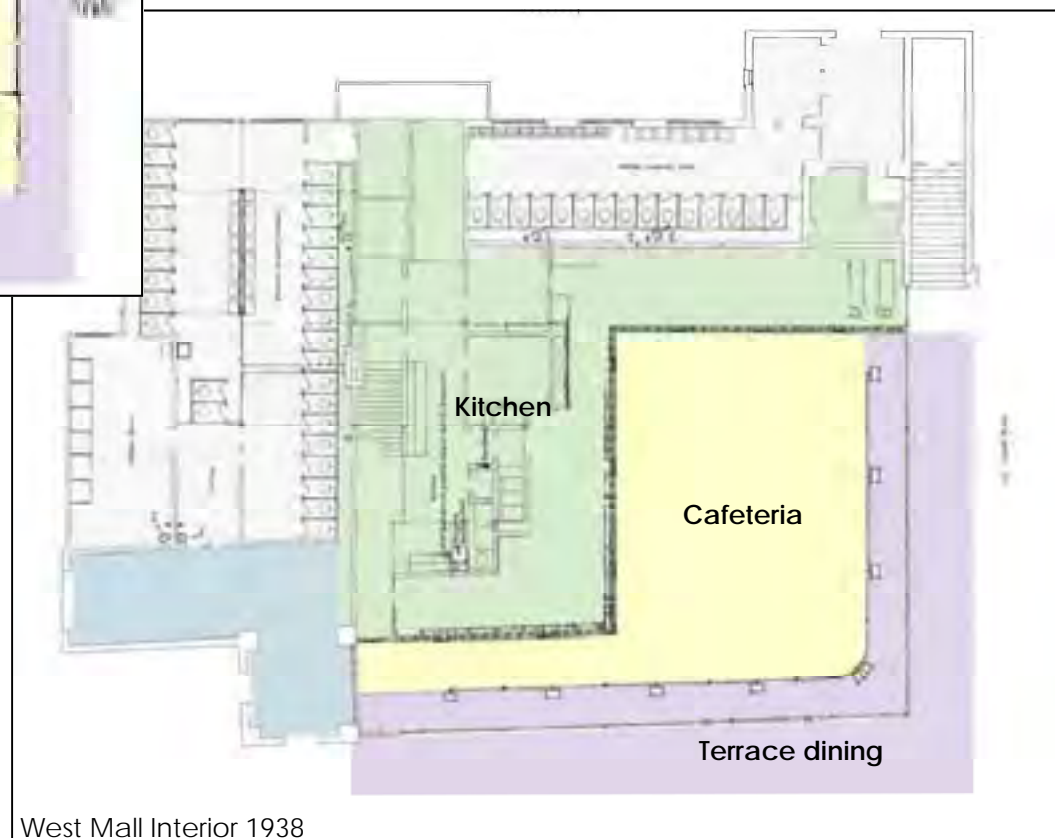

West Mall Interior 1938

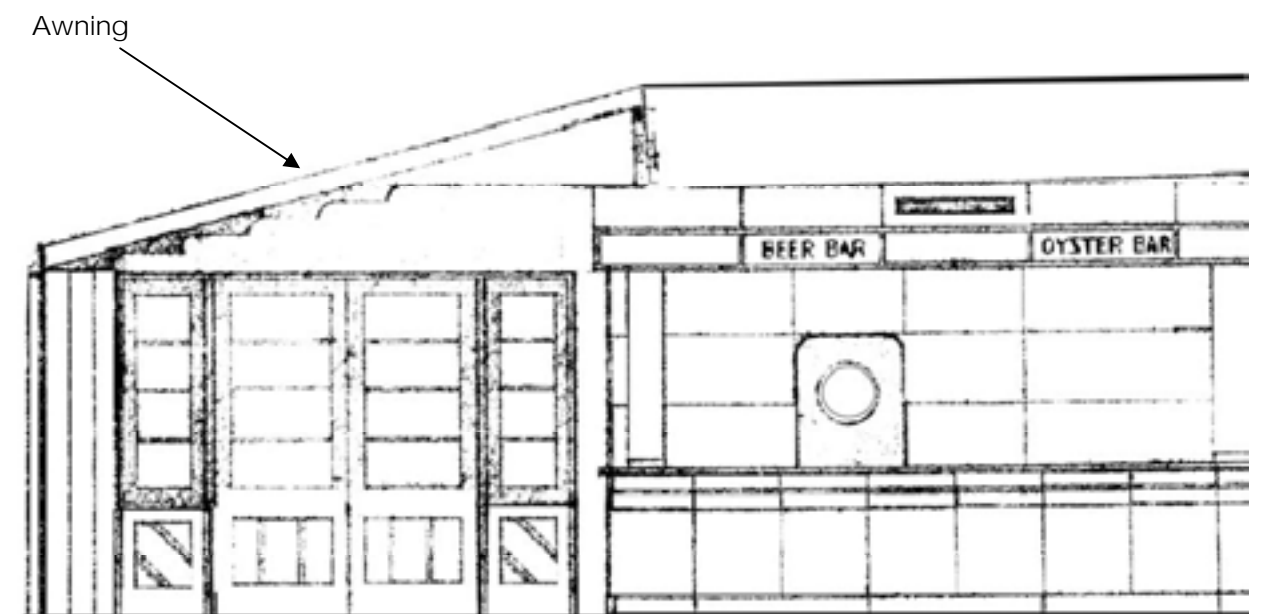

Detail: 1935 Drawing of interior of West Mall Building. Monel counters, cabinets and walls. Wood paneled doors enclosed the area under the terrace awnings.

**WEST MALL BUILDING -
ALTERATIONS (1950's & 1960's)**

BY 1958

- Rehabilitation of the comfort station (bathrooms redone)
- A clock was added to the south elevation of the tower. The style of the clock matches those used on the East and West Bathhouse
- A metal awning was added over a section of the outdoor seating.
- A second outdoor seating area was added to the west of the tower.

By 1961

- Addition of 'Glass Solarium' on the roof.
- Installation on a wood and glass windscreen to partially enclose the outdoor dining.
- The open area to the west of the tower was partially boxed in—a roof was added and the back wall was faced with wood paneling (enclosure).

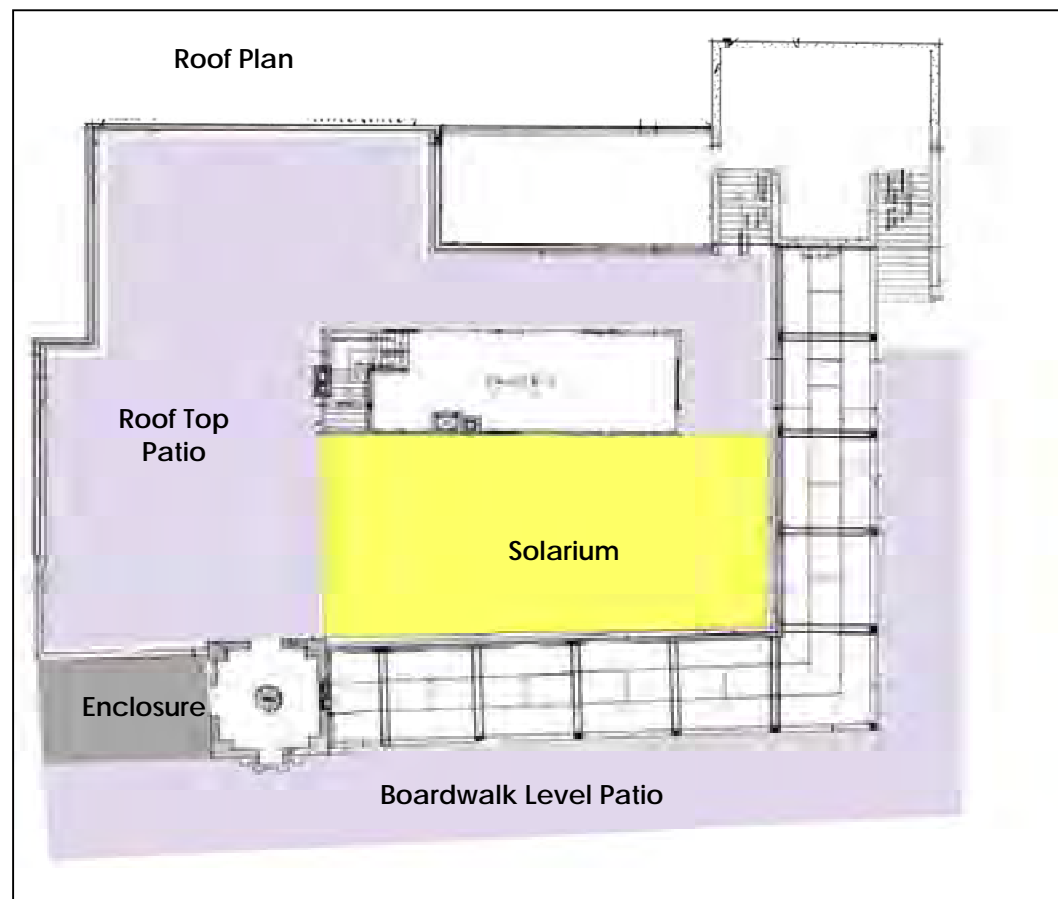

**WEST MALL BUILDING
ALTERATIONS (1970'S—PRESENT)**

- Removal of 'Glass Solarium'
- Removal of the original 1930 pilot house (roof level building).
- Removal of original roof railing & tower clock.
- Removal of exterior stair to roof deck on the east elevation.
- Roof level closed to public.
- Installation of a 'Take Out' window on east façade (former stair location).
- Installation of kitchen vents on roof.
- Installation of 'bubble' top style awning over part of seating area. The awning is almost two stories tall—dwarfing the east side of the façade. The awning also reduces the horizontal character of the building.
- Installation of a metal and glass windscreen to partially enclose the outdoor dining. The windscreen dominates the façade blocking the building from the boardwalk and the beach.
- Removal of all 1930's finishes in cafeteria.



Floor Plan—2013

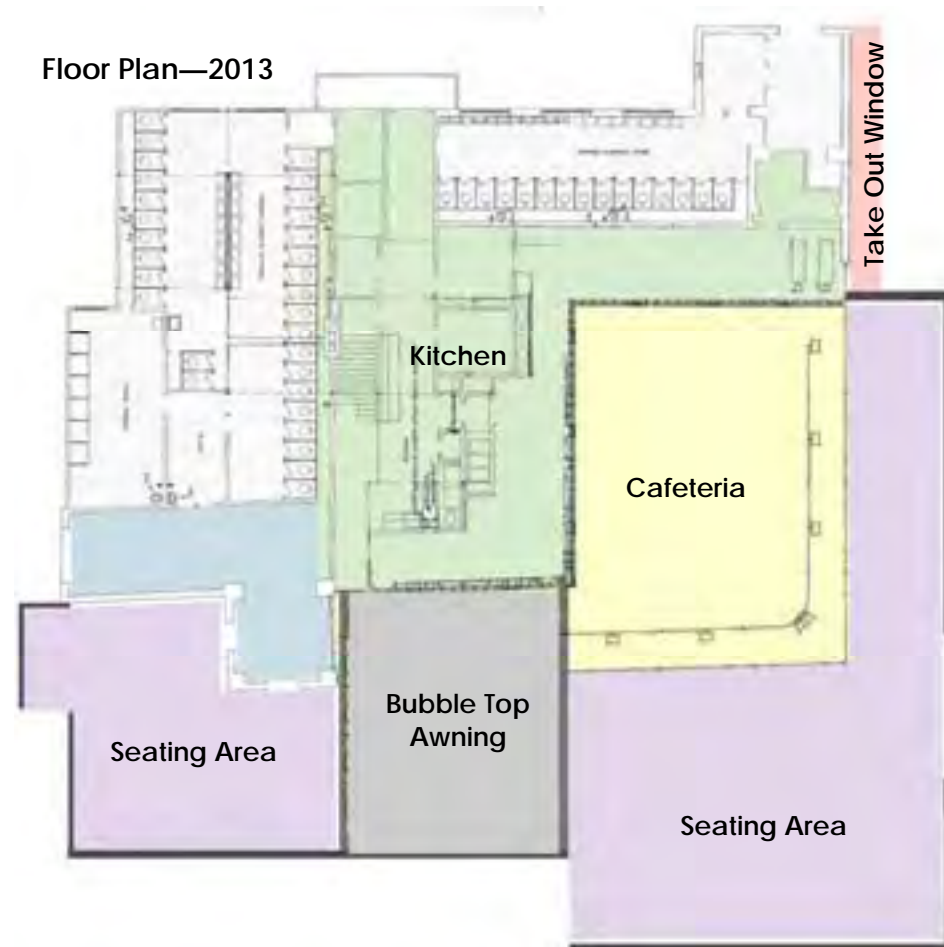

West Mall Building, 2013



WEST MALL BUILDING SUMMARY OF EXISTING CONDITIONS

Overall the West Mall Building is in fair to good condition. Deterioration, however, is apparent in multiple locations especially at the roof level.

- **Water Inflation.** The brick at the parapet displays evidence of prolonged water infiltration. Poor or insufficient flashing has allowed water to enter the wall cavity resulting in efflorescence (white staining) and brick deterioration. The water appears to be entering the wall cavity through the back of the parapet wall and at the junction of the roof and parapet.
- **Brick Deterioration.** Moisture traveling through the wall and emerging on the face of the brick has resulted in extensive brick spalling at the parapet level. Many bricks have already been completely lost and others are failing.
- **Sandstone Cracking.** A number of the sandstone cap stones on the tower are cracked.

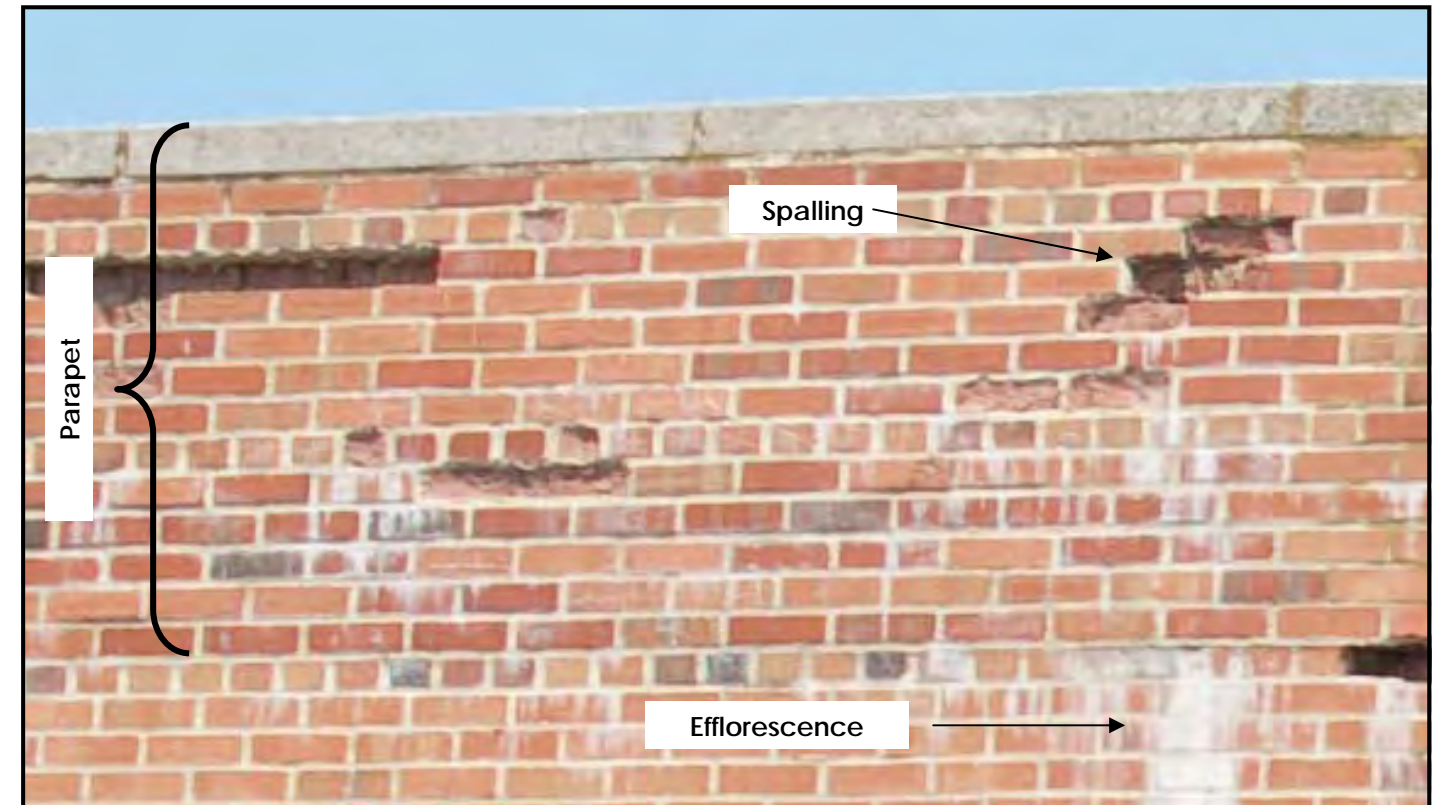

Detail of brick deterioration at parapet of West Mall Building.

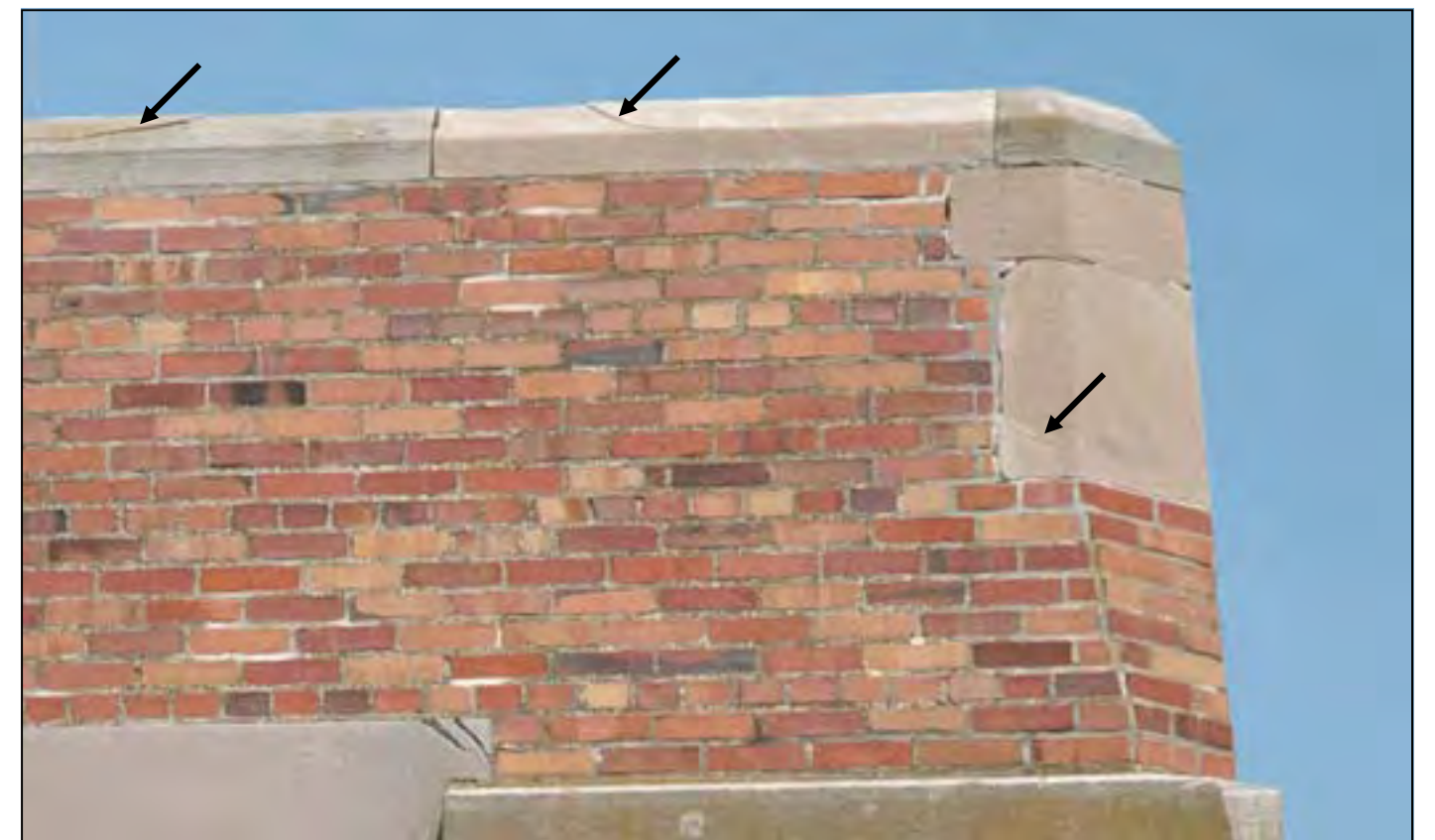

Detail of sandstone deterioration at West Mall Building.

WEST MALL BUILDING: USE, SIGNIFICANCE & PRESERVATION

SPACE & USE

Recommendation:

The West Mall Building is currently functioning as the only dining establishment in the Central Mall zone. The loss of access to the roof has greatly reduced the available square footage, specifically reducing patron seating capacity.

Historic (1938)

| Description | Sq. Foot (Aprox.) |
|----------------------|----------------------|
| Cafeteria | 2100 sq. ft. |
| Lobby: | 420 sq. ft. |
| Restrooms | 1680 sq. ft. |
| Kitchen/Staff Areas: | 800 sq. ft. |
| Boardwalk Patio: | 2,800 sq. ft. |
| Roof Top: | 6,000 sq. ft. |
| Total: | 15,000 sq. ft |

Current (2013)

| Description | Sq. Foot (Aprox.) |
|----------------------|----------------------|
| Cafeteria | 2100 sq. ft. |
| Lobby: | 420 sq. ft. |
| Restrooms | 1680 sq. ft. |
| Kitchen/Staff Areas: | 800 sq. ft. |
| Boardwalk Patio: | 4,000 sq. ft. |
| Roof Top: | 0 sq. ft. |
| Total: | 9,000 sq. ft. |

SIGNIFICANCE

The West Mall Building is significant:

1. As an important component of the formal Beaux Arts plan of Jones Beach State Park. The specific location reinforces the strong axial component of the Boardwalk.
2. For its architectural design. The building reflected careful thought regarding use, layout, materials and ornamental design. These elements are skillfully used together to create a structure that works individually and as part of the overall park design.

Significant Elements include:

1. **Materials.** The use of specific materials was consistent throughout Jones Beach and helped maintain a sense of unity through the large park. Important materials uses at the West Mall Building include Barbizon Brick, buff colored sandstone and copper trim element. Copper was especially used in the early buildings at Jones Beach (pre-1940)
2. **Design Elements.** Important design elements include:
 - Low horizontal massing of the building anchored by the squat tower.
 - Symmetry of the building in relation to the central mall and other boardwalk buildings.
 - High level of ornamentation on primary elevations and spaces.
 - Nautical theme: overall building shape and design and ornamental elements. Specifically wave balcony, pilot house, port hole windows & ship style railings.
3. **Function & Design.** The relationship between design and function is significant. The level of ornament on the building reflects its use. The highly ornamented section along the boardwalk reflects a public use while the relative simple rear facades reflects the non-public access or use.
4. **Period of Significance: 1930-1938**

TREATMENT

Recommendations: Rehabilitation

Retention and preservation of Historic Materials

1. The impact of alterations, repairs and even code upgrades should be weighed in terms of their effect on historic fabric. Code requirements specifically the ability to meet health and safety, energy codes and ADA requirements should be addressed without damaging historic spaces, features or finishes.

Repair of Historic Materials and Features

1. Many important features are threatened by deterioration including the sandstone, Barbizon brick & copper trim features. When necessary deteriorated fabric should be replaced in kind. While replacing in kind is an option the integrity of the building is tied to its original fabric so the primary goal should be the preservation of historic fabric.

Replacement of Missing Historic Features

1. The West Mall Building has lost many of its significant features. Where possible historic documentation should be used to replicate losses due to deterioration or alteration. Missing or altered elements include:
 - Roof Level terrace
 - Nautical themed elements, ship style railing, pilot house, port hole windows on doors.
 - Reinstallation of fabric awning to connect the building with the other structures at Jones Beach.

Removal of Inappropriate modern additions/features

1. Removal of intrusive metal and glass windscreen & re-establish historic building perimeter.
2. Removal of two story bubble canopy.

**ZONE 1: CENTRAL MALL AREA
EAST MALL BUILDING**

East Mall Building, 1935-1964

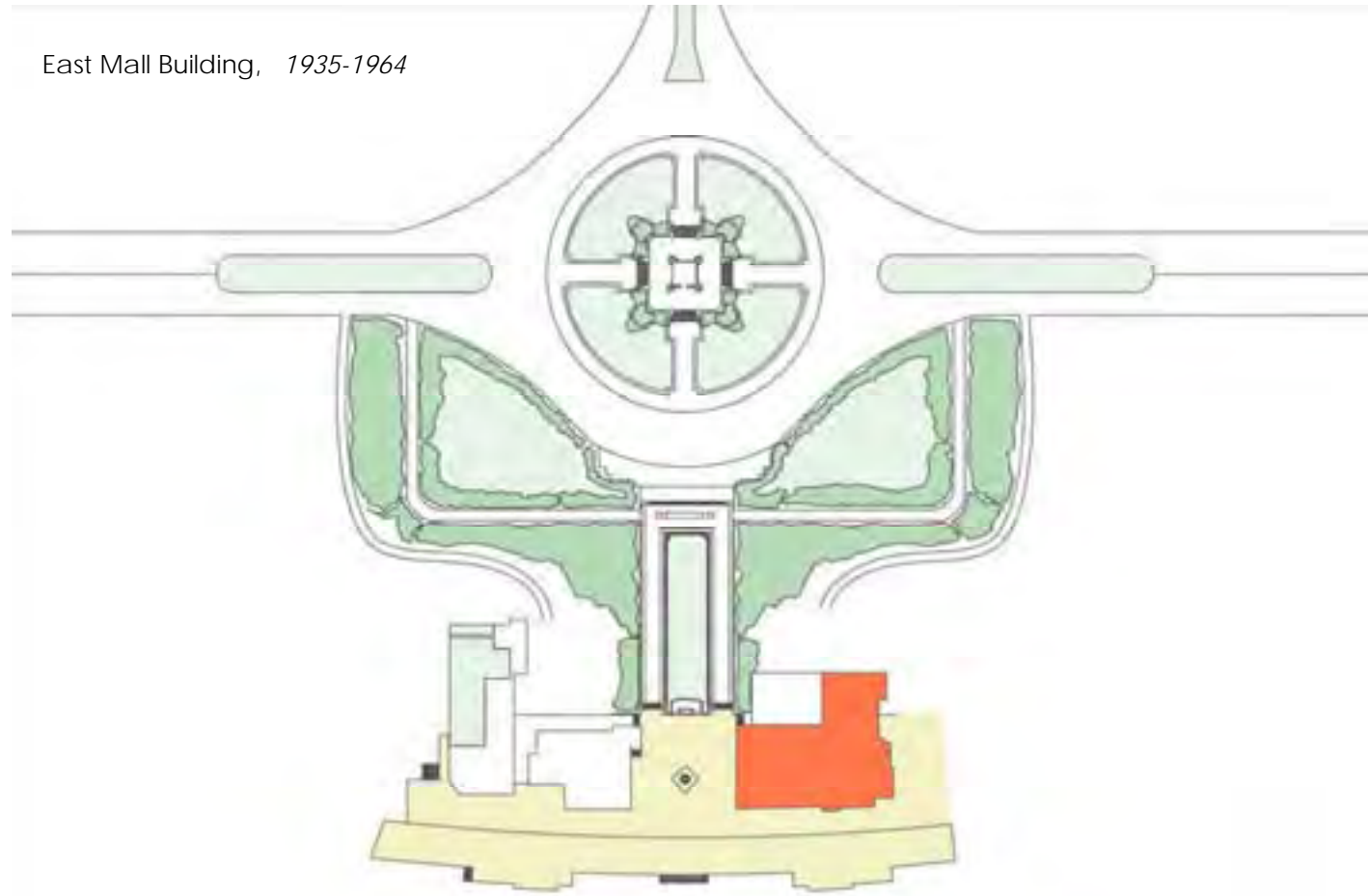

**EAST MALL BUILDING
CHRONOLOGY OF DEVELOPMENT & USE**

- Originally located at the south end of the Central Mall, the East Mall Building was one of the major buildings lining the Boardwalk.
- The first permanent building on the site was designed by , F.L. Gregory AIA in September of 1934.
- Drawings were approved & signed by Robert Moses. The East Mall building drawings were one of the few original sets of drawing with Moses' signature.
- The original "East Mall Building" was approximately 20,000 sq ft with a 4,000 sq ft patio. The building featured a formal dining room and café dining outside.
- In the post-war period the East Mall restaurant, like the Marine Dining (WBH), was converted into more casual—cafeteria dining.
- The East Mall Building was destroyed by a fire in 1964.
- Skidmore Owings & Merrill designed the 'new' Boardwalk Restaurant c.1967 This buildings falls outside the period of significance for the park.
- The 'new' Boardwalk Restaurant was demolished due to structural failures in 2004.
- The site is currently vacant.

East Mall Building, 1935-1964
Photo: 1949



Central Mall Restaurant, 1967-2004
Photo: c.1970



Vacant Lot, 2004—present
Photo: 2013



EAST MALL BUILDING (1935)
CHRONOLOGY OF DEVELOPMENT & USE

- The East Mall Building was built to provide a 'sit down' restaurant at the Central Mall. The West Mall Building provided casual café style dining—the East Mall was a more formal alternative.
- The central space in the East Mall Building was a main dining room which featured a music stage and ornate bar. The dining room overlooked the Boardwalk and Central Mall.
- A "Tea Terrace" was located behind the main block of the building along the Central Mall. The Tea Terrace included a wood shelter and patio area.
- The Tea Terrace was originally organized around a open dance floor. The terrace was used for dining and dancing from 1935-post WWII. After WWII the dance floor was converted to a seating area.
- The interior of the structure was also altered in the post-war period to respond to changing demographics. The restaurant was converted into a self-serve seafood restaurant.



Jones Beach State Park, East Mall Building c. 1938

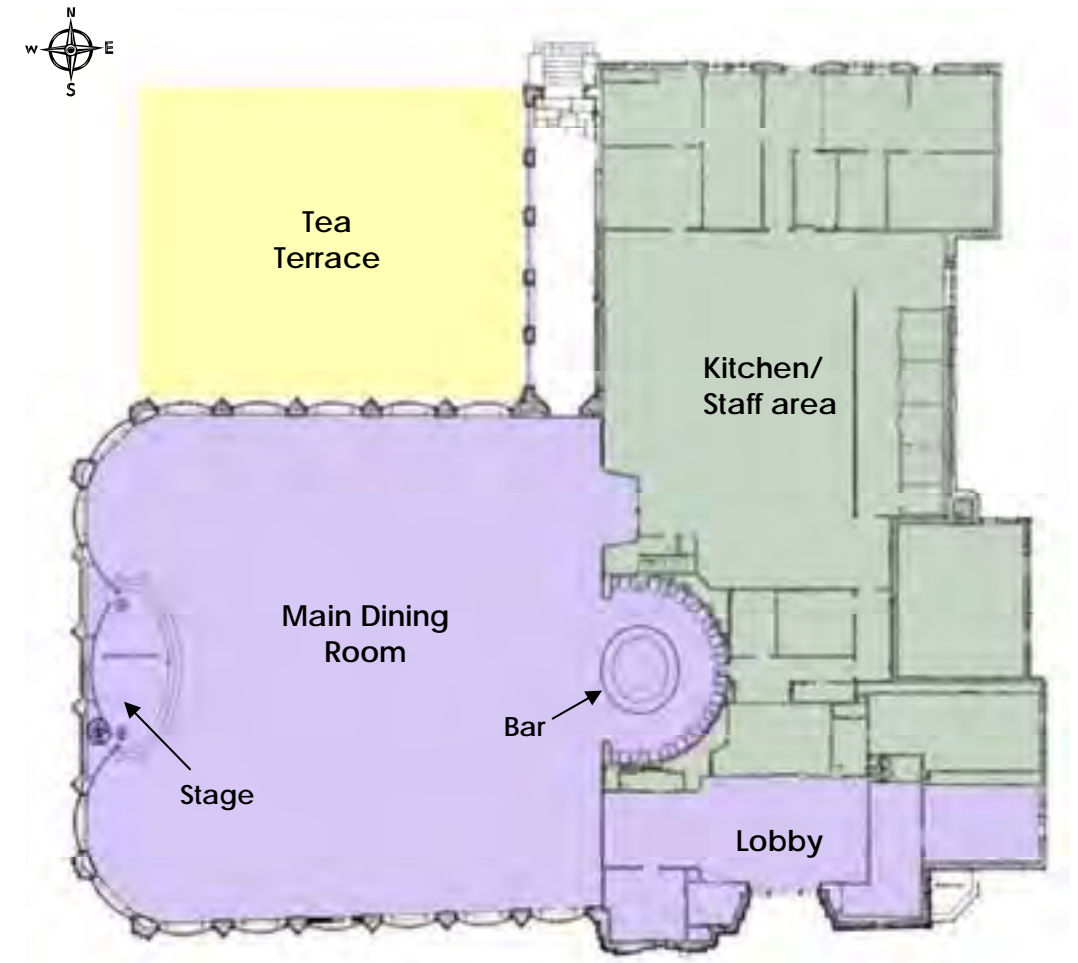

East Mall Building
 c. 1936 Highlighted
 areas: public
 spaces (purple),
 staff areas (green),
 patio (yellow).



East Mall Building Terrace c. 1960

EAST MALL BUILDING (1935)
DESCRIPTION

EXTERIOR

- The East Mall Building was designed to respond to the Central Mall and Boardwalk. The building was also designed to be a part of the larger Jones Beach design aesthetic. The building featured primary facades on beach, boardwalk and Central Mall elevations. These facades featured a high level of ornamentation and detail.
- The building was a low horizontal structure anchored by an asymmetrically set tower. The tower reflects Art Deco style architectural influences.
- The horizontal nature of the building was reinforced by the wide band of windows, the brick parapet and the low copper roof shed.
- The building was constructed of Barbizon Brick and Ohio sandstone. The sandstone was rock-faced with the exception of the lintels and sill which were honed sandstone.
- Each building bay was defined by sets of sandstone piers. Each opening featured a bowed window. The large window opening was divided into many operable small lites.
- The area below the windows was also bowed and featured bricks set in header rows.
- The areas above the windows were flat and featured soldier courses of brick.
- The main public entrance (right of tower) featured a large sheltered opening framed in honed sandstone. The stone over the door was carved with stylized Art Deco ornament (waves, fins, geometric shapes etc.) The doors were paired bronze doors with plate glass lights (see detail right).

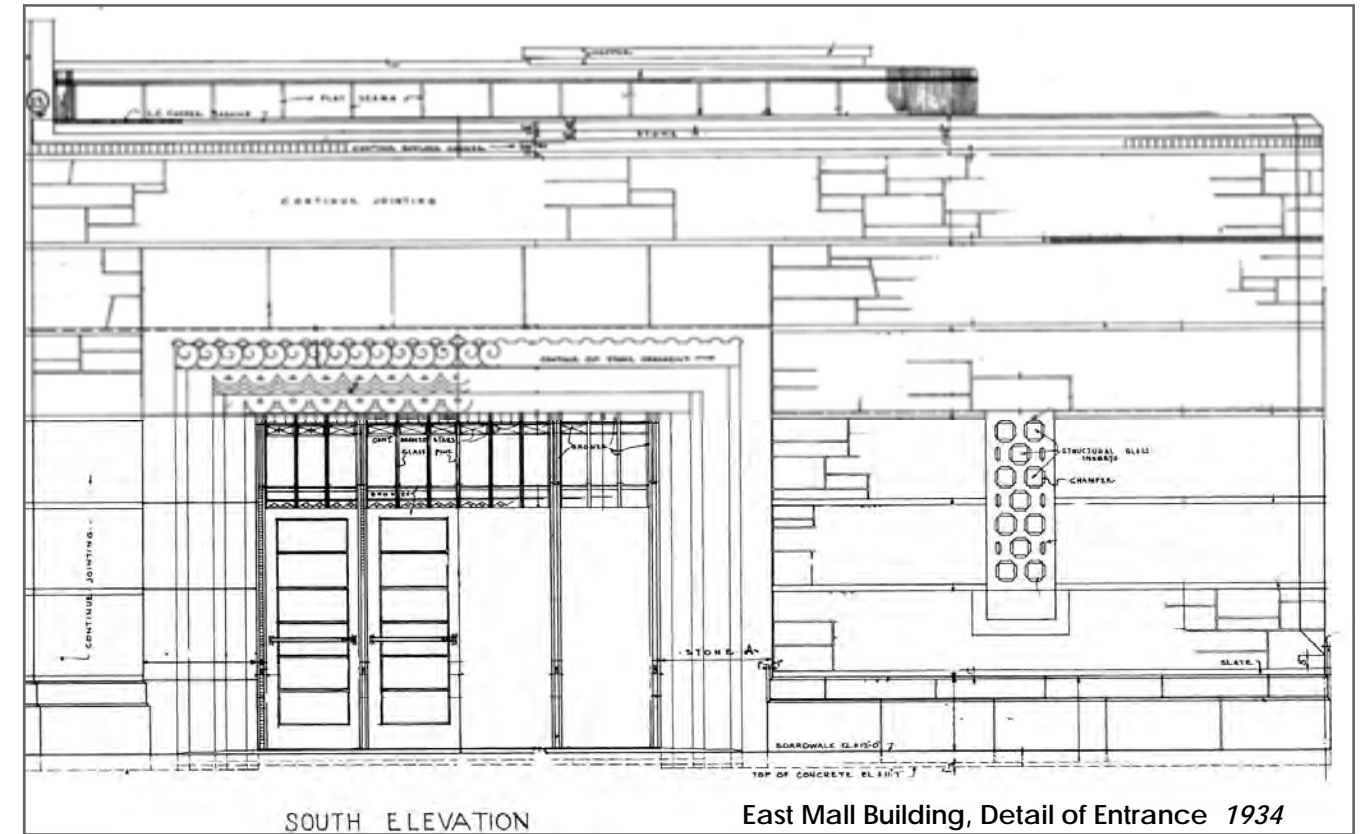

East Mall Building, 1940's

Detail from Original Drawings c.1934

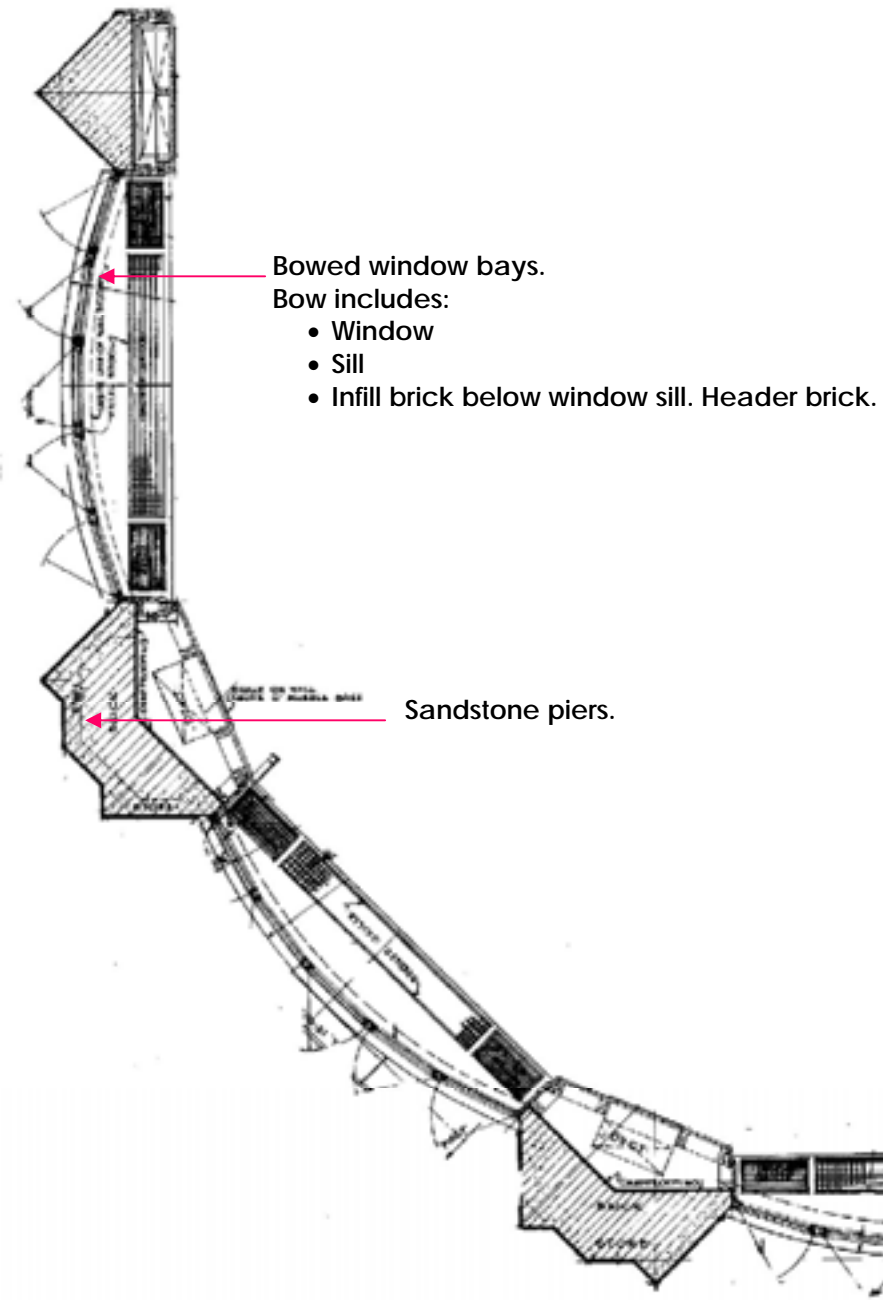

East Mall Building, 1940's

EAST MALL BUILDING (1935)
DESCRIPTION

INTERIOR

- The East Mall Building was constructed during a much more formal time at Jones Beach and America. Patrons came to Jones Beach for the day; spending the day bathing or enjoying the boardwalk followed by dinner at one of the park's restaurants. The East Mall Building provided a companion dining space to the Marine Dining Room in the West Bathhouse. The finishes in the East Mall Dining Room reflect this more formal use.
- The main dining room was a large oval space with a ornamental plaster covered ceiling. A circular recessed dome with scalloped edges was centered in the room—reinforcing the circular shape of the room.
- Large fluted columns with blue and metallic (silver) paint supported the ceiling.
- The decorative finishes also reflect the formal use and the continuity of the whimsical beach theme used throughout Jones Beach. For example the room was finished with cool blues with underwater murals on the wall and The bar featured a tri-color terrazzo floor with waves and fish. These types of details were executed throughout the space including the grilles, wainscoting and doors.



Main Dining, East Mall Building c.1950

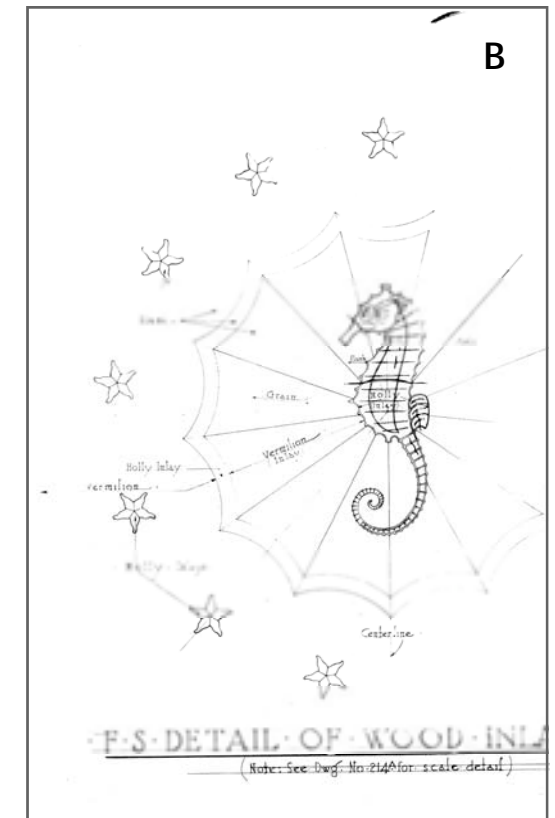
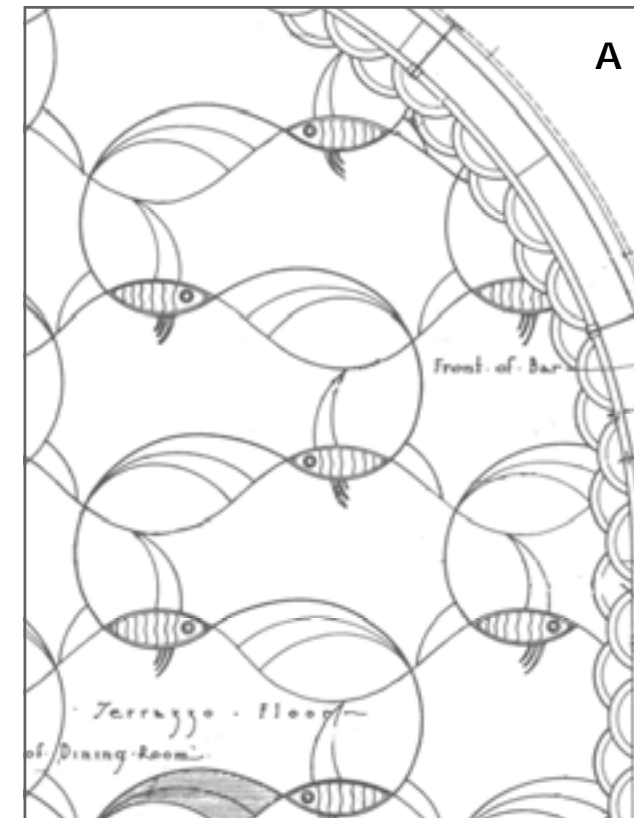
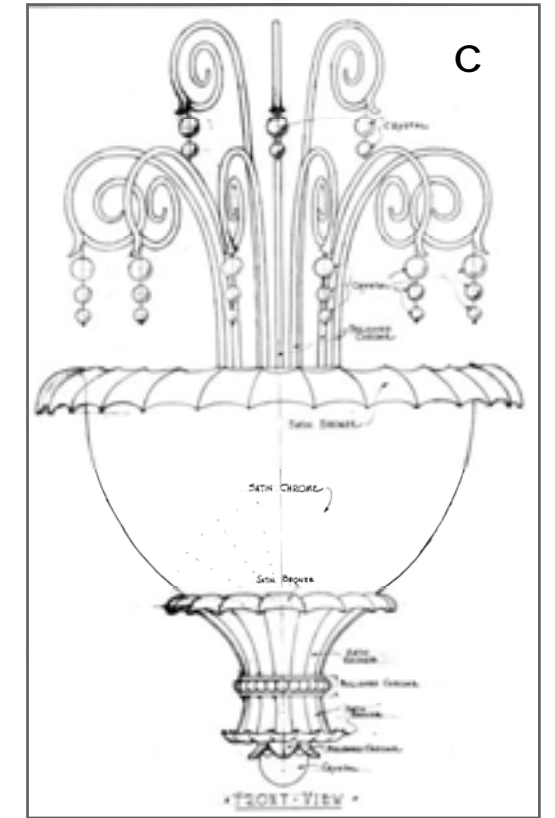

Main Dining, East Mall Building Details (A) Terrazzo Floor in Bar, (B) Seahorse Inlay in Bar, (C) Chrome & crystal chandelier

EAST MALL BUILDING (1935)
DESCRIPTION

PATIO

- The East Mall Building featured a Tea Terrace on the northwest corner. The terrace featured a quarry tile dance floor in the center and a teak bar. Umbrella sheltered tables lined the dance floor.
- The terrace was framed on the east with an sandstone arcade and on the south by the building.
- The west and north elevations featured low sandstone walls and high vegetation screens that shielded the parking lot and Central Mall.

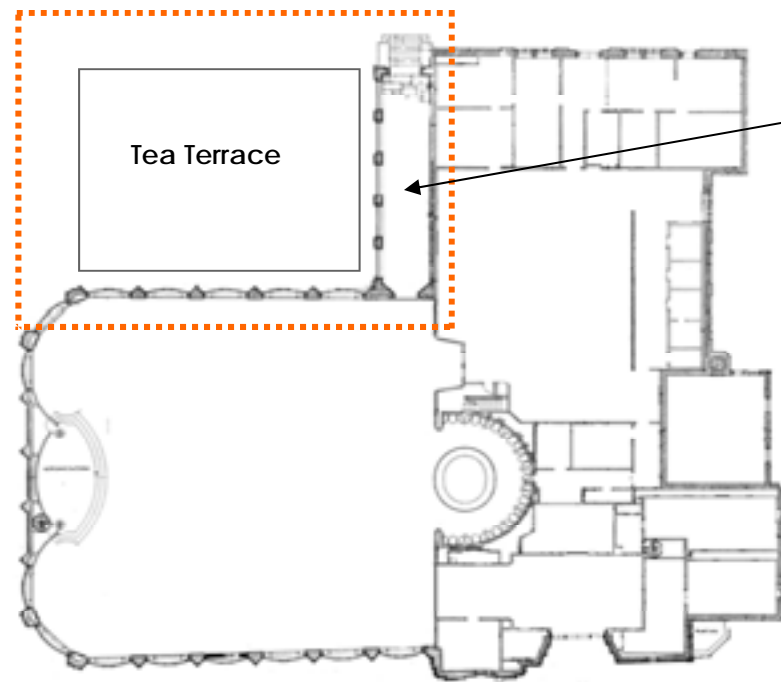

East Mall Building (1934) Floor Plan



Arcade & Tea Terrace
c. 1960

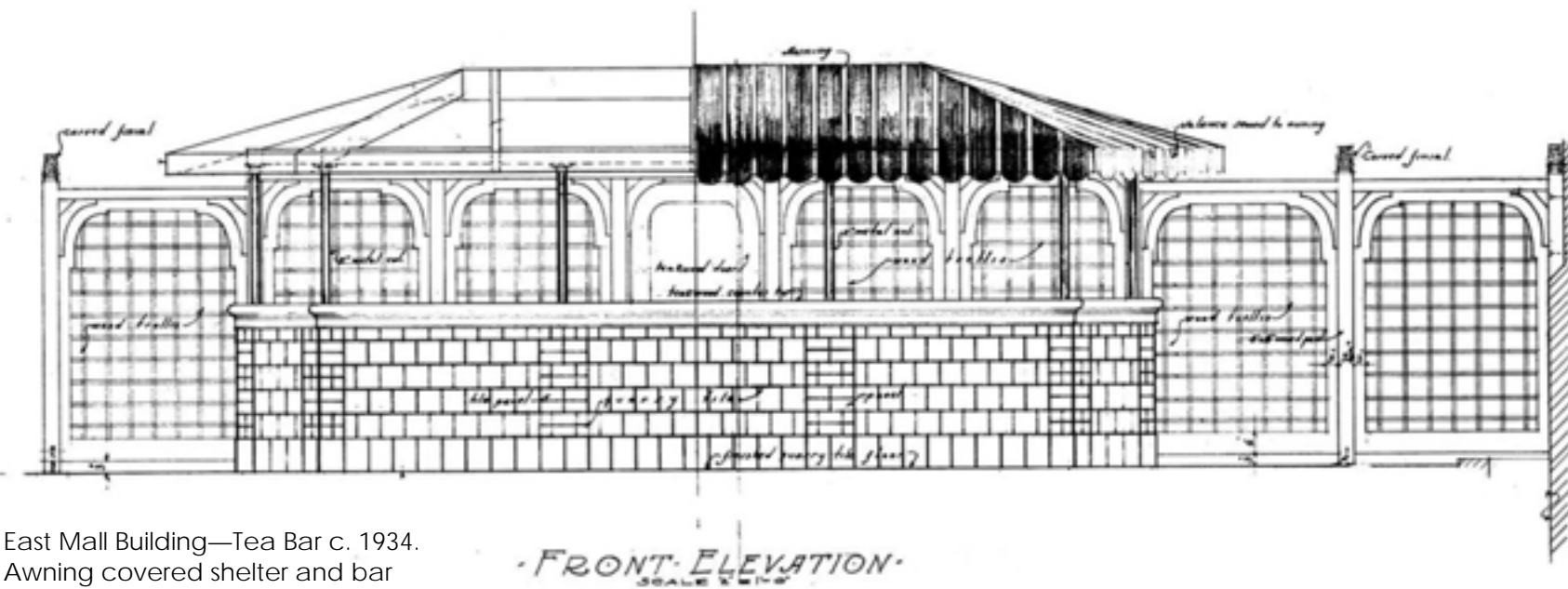

East Mall Building—Tea Bar c. 1934.
Awning covered shelter and bar
constructed primarily of teak.

FRONT ELEVATION
SCALE 1/8" = 1'-0"



Tea Terrace c. 1949

EAST MALL BUILDING: USE, SIGNIFICANCE & PRESERVATION

SPACE & USE

Recommendation:

The building lot is currently vacant and serves no architectural or public use. The East Mall Building originally housed semi-formal and café dining opportunities at a central location within the Park. It is recommended that a structure be built to re-establish this use.

| Description | Sq. Foot (Aprox.) |
|----------------------|-------------------|
| Main Dining Room: | 5,440 sq. ft. |
| Bar: | 800 sq. ft. |
| Lobby: | 680 sq. ft. |
| Lounge: | 300 sq. ft. |
| Restrooms | 620 sq. ft. |
| Kitchen/Staff Areas: | 12,000 sq. ft. |
| Terrace: | 4,000 sq. ft. |

SIGNIFICANCE

The East Mall Building was significant:

1. As an important component of the formal Beaux Arts plan of Jones Beach State Park. The specific location reinforces the strong axial component of the Boardwalk.
2. For its architectural design. The building reflected careful thought regarding use, layout, materials and ornamental design. These elements are skillfully used together to create a structure that works individually and as part of the overall park design.

Significant Elements include:

1. **Materials.** The use of specific materials was consistent throughout Jones Beach and helped maintain a sense of unity through the large park. Important materials uses at the Administration Building include Barbizon Brick, buff colored sandstone and grey slate trim.
2. **Design Elements.** Important design elements include:
 - Low horizontal massing of the building anchored by the squat tower.
 - Symmetry of the building in relation to the central mall and other boardwalk buildings.
 - Tooling, coursing and patterning of the sandstone & brick,
 - The use of repetitive bowed bays framed by stone piers.
 - High level of ornamentation (stylized beach themes) around primary entrance.
3. **Function & Design.** The relationship between design and function is significant. The level of ornament on the building reflects its use. The highly ornamented section along the boardwalk reflects a public use while the relative simple rear facades reflects the non-public access or use.
4. **Period of Significance: 1935-1964**

TREATMENT

Recommendations: Rehabilitation

Replacement of Missing Historic Features

1. The East Mall Building was a critical part of the overall design of the Central Mall area and Jones Beach as a whole. The building provided the symmetry necessary to balance the Central Mall. In the future a structure of some kind should be constructed on the site to re-create the balance of the original Beaux Arts park plan.
2. When the structure is built it should maintain the harmony of the Park by using or referencing significant materials and design elements of characteristic of Jones Beach.

EAST MALL BUILDING

**HISTORIC PHOTOGRAPHS
& ORIGINAL DRAWINGS**

East Mall Building c.1946



East Mall Building c.1960



East Mall Building c.1955 Post- conversion to self-service restaurant



East Mall Building c.1964 (After Fire)



**ZONE 1: CENTRAL MALL AREA
ADMINISTRATION BUILDING**

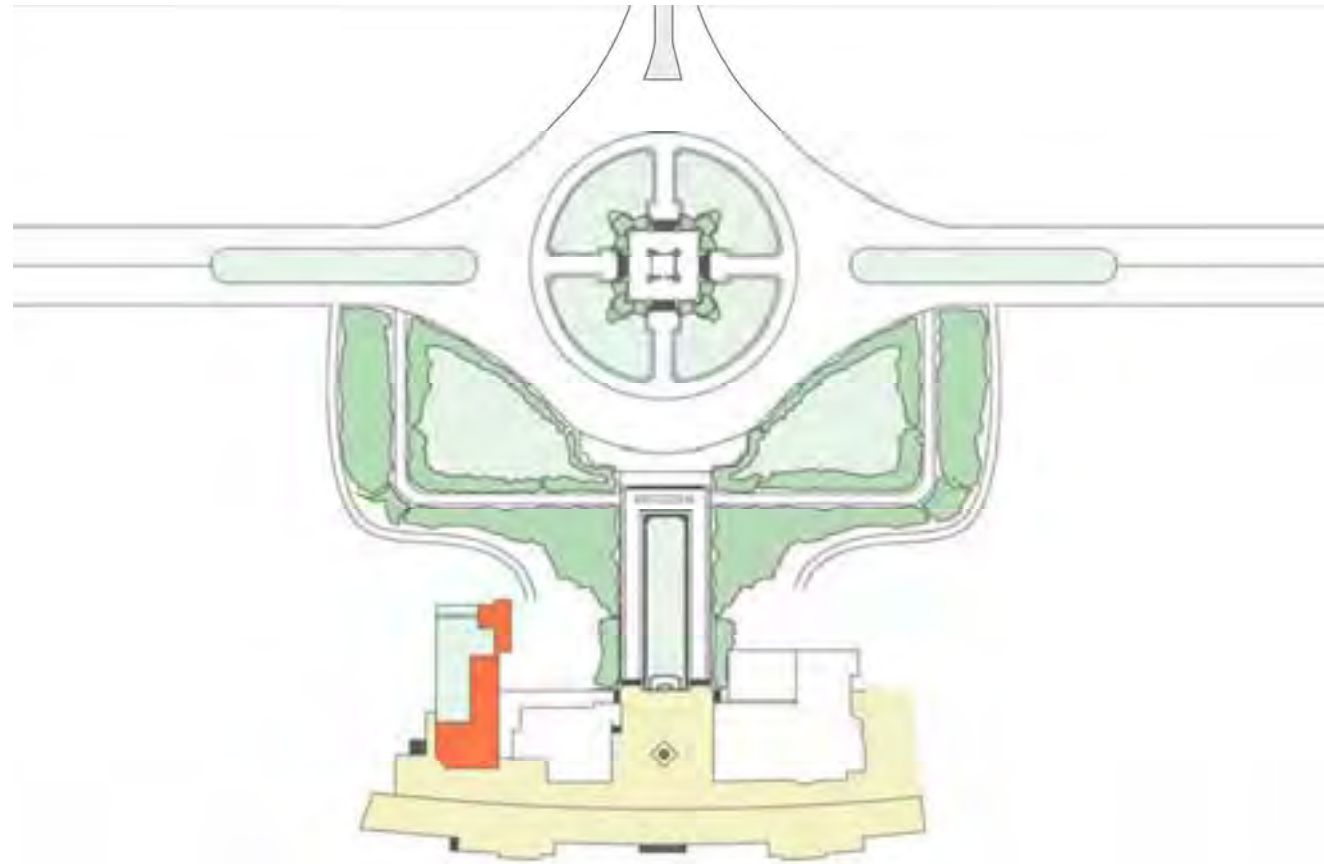

**ADMINISTRATION BUILDING
CHRONOLOGY OF DEVELOPMENT & USE**

- Located just off the Central Mall, the Administration Building is one of the major buildings lining the Boardwalk.
- Originally designed by William E. Haugaard, AIA in September of 1944.
- Alterations were made to original design prior to the building's construction in 1950. The new design was based primarily on 1944 drawings with the addition of a small block on the north end of the building. The new addition was designed to accommodate the Police headquarters. Design changes were executed by L.I.S.P.C. staff.
- The project was funded by the New York State Postwar Public Works Commission.
- The building was designed to provide office space, a first aid station, a beach shop and public information/reception center.
- The Administration Building (1950) replaced a temporary-wood framed administration building (1935-1954) that was located on the east side of the Central Mall behind the Boardwalk Restaurant.



Administration Building

5-2013



Administration Building

Under construction c. 1950

ADMINISTRATION BUILDING CHRONOLOGY OF DEVELOPMENT & USE

- The Administration building, as the name suggests, was primarily designed to provide office space. The building was constructed in a central location within the Park since it also was to serve as an official interface between the Park patron's and Park's staff.
- The building provided important public uses including a first aid station, an information center, restrooms and a beach shop.
- Prior to the construction of this building in 1950, Jones Beach Park's staff offices were housed in a temporary wood frame building located to east of the Central Mall. (see below)
- The new Administration Building more than doubled the available square footage for administration, and provided a headquarters for the Police at the center of the Park.
- The beach shop, first aid station and reception room are all still located in their historic spaces within the building and still used for their original purposes.
- The administration offices are still used by Park's staff. A few of the rooms have been repurposed but the configuration of the space has not significantly changed since the building was built.

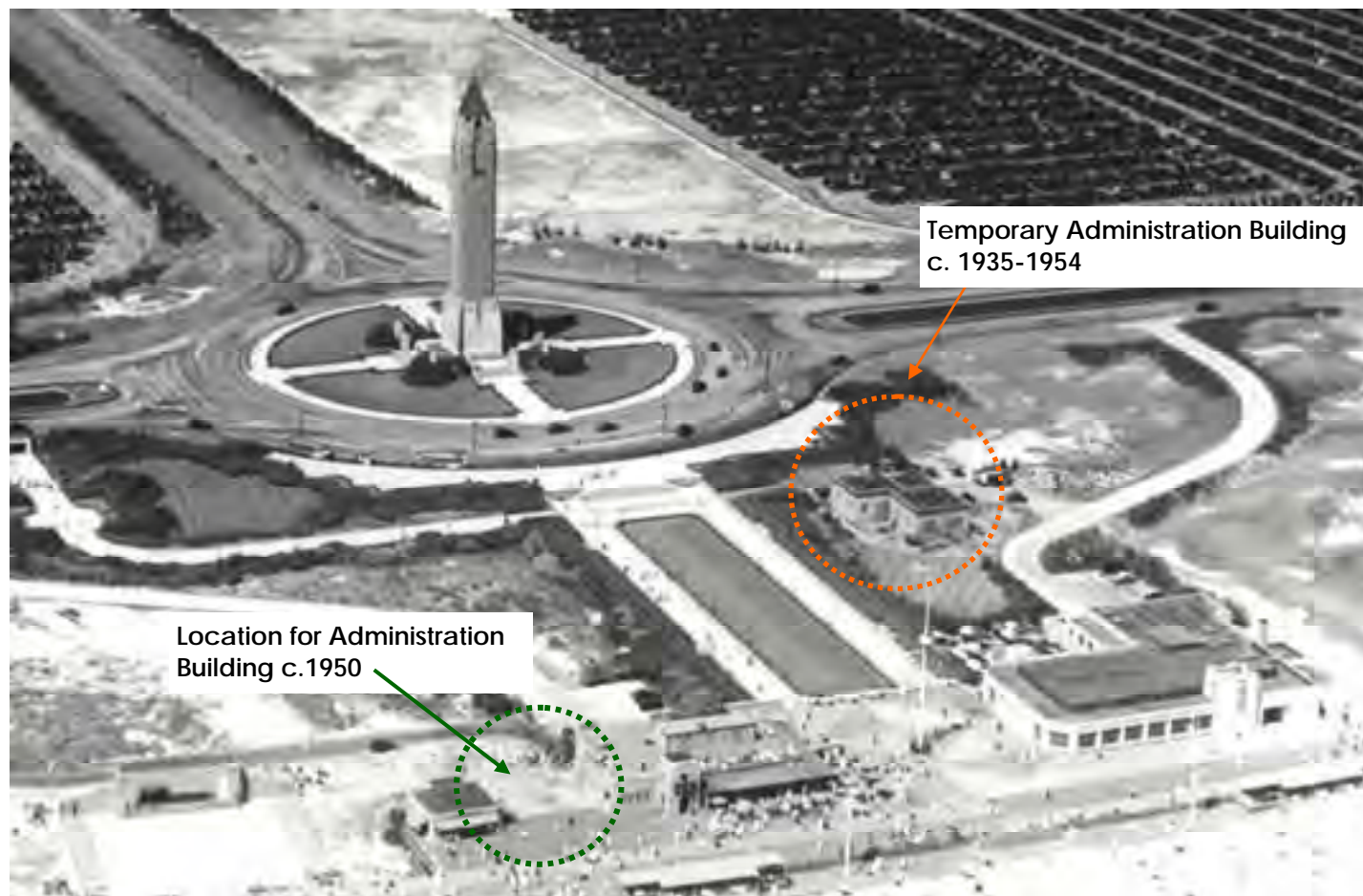

Jones Beach State Park, Central Mall & Boardwalk c. 1938



Administration Building Floor Plans c. 1950 Highlighted areas (green) is office spaces, (blue) is police offices and (purple) is public areas.



Administration Building

1954

ADMINISTRATION BUILDING PHYSICAL DESCRIPTION

- The design of the Administration Building reflects its dual use: park patrons and park staff. The public 'block' of the building is set along the boardwalk and features the high style decorative elements typical of Jones Beach. The larger 'office' section of the building is set back and is executed in a much simpler style.
- In addition to the level of ornamentation, the structure of the building also reflects its use. At the boardwalk level the building maintains the low-one story profile of the adjacent boardwalk buildings. The building however is two-stories. The boardwalk level is actually the second story of the building. The ground floor is below the boardwalk level. The ground floor is used for storage.
- A long two story block extends back behind the public block. This section features two almost even floors of offices and administration spaces. The change in height between the two sections of the building is accomplished at the stair tower that divided the two section of the building.
- The public areas at boardwalk level features large rooms with high ceilings (13' 2") and larger windows and doors. The administration/office section has two levels with lower ceilings: the first floor is 7' 6" and the second floor is 8' 0". The ceiling height in the basement level is 8' 2".



Administration Building—West Façade (2013). Note the transition between the public 'block' of the building (front -right) and the Park's staff section of the building (rear). The First Aide Station on the Boardwalk is primarily constructed on coursed sandstone with decorative trim and projecting piers. The block to rear is much more simply executed with Barbizon brick with limited sandstone trim.

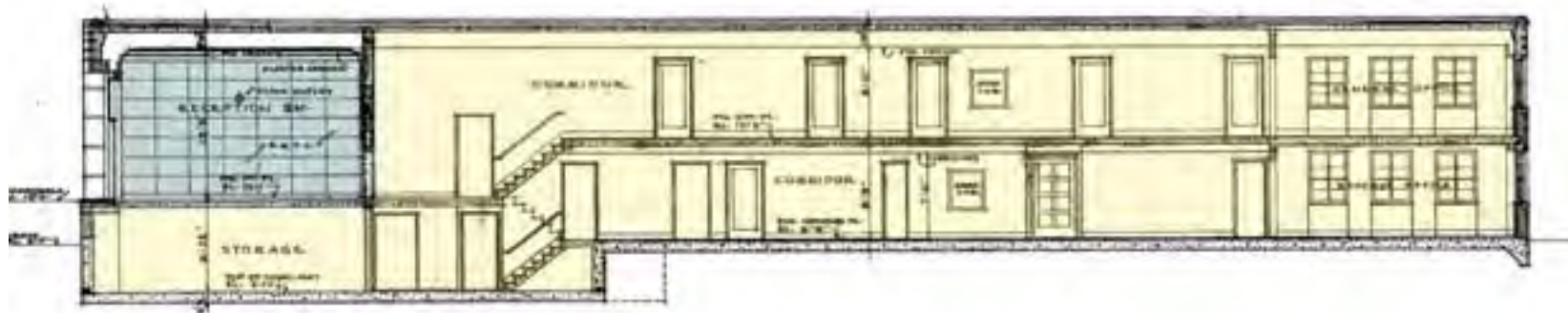

Administration Building ,
Drawing 1944

Parks Staff Space
 Public Space



Administration Building, 2013

ADMINISTRATION BUILDING PHYSICAL DESCRIPTION

- The Administration Building is a two-story brick building with sandstone trim. The primary elevations face the boardwalk and beach. Sandstone trim and other decorative elements are concentrated on these facades. The secondary elevations are treated much more simply, primarily constructed of brick with limited sandstone banding and sandstone lintels.

Primary Facades:

- The south and west (boardwalk) elevations feature buff-colored, rock-faced sandstone bays separated by large opening for windows or doors. Early photographs indicate that the openings were shaded by fabric awnings. The areas below the window sills are filled with Barbizon brick. The window lintels, sills and capstones are honed sandstone.
- Each bay is framed by sandstone piers. The ashlar courses of sandstone are accented by thin horizontal courses of grey slate. The grey slate is also used to divide the decorative brick courses on the parapet. The stone joints are pointed with a light buff colored mortar that closely matches the sandstone color.
- The Barbizon brick in the parapet is set in three courses of 'soldier' brick capped by a single row of headers. Each brick course is separated by thin layer of slate. A light buff colored mortar is used on the joints.
- The inset areas below the windows sills on the primary facades are filled with Barbizon brick set in header courses. Again, a light color mortar matching the sandstone would have been used.
- The windows on the primary facades were originally metal casement or awning style windows. This includes the large storefront windows south façade. The windows are now metal replacements that do not reflect the historic style/divisions. Instead of smaller operable-divided light windows, the windows are large fixed glass panes. The replacement windows are also tinted reflective glass.
- The bays on the west elevation (boardwalk) are filled with coursed sandstone.
- Two of the three bays on the west elevation (boardwalk) feature a set of three deeply recessed windows. The windows resemble gun slits and each opening has a narrow wood window.
- The exterior doors on the south facade were originally paired wood panel doors (cherry). Each door featured a set of three glass lights. The doors are now metal frame with large lights. The glass in the window is also tinted and reflective.
- The First Aide door on the west elevation matched the doors on the secondary elevations. The wood paneled door was divided into eight even lights. The current door is wood paneled with two side by side lights.

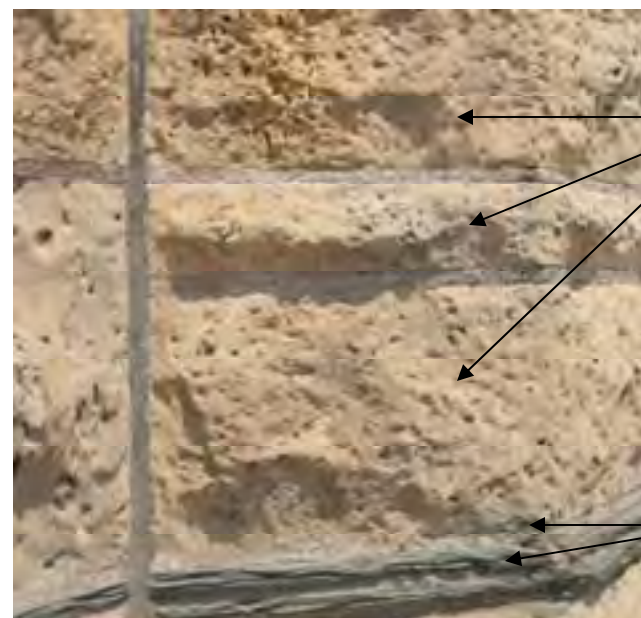

Ohio Sandstone. Buff-colored with a rock-faced finish.

Slate coursing.

Administration Building - Detail of sandstone and slate coursing on piers.

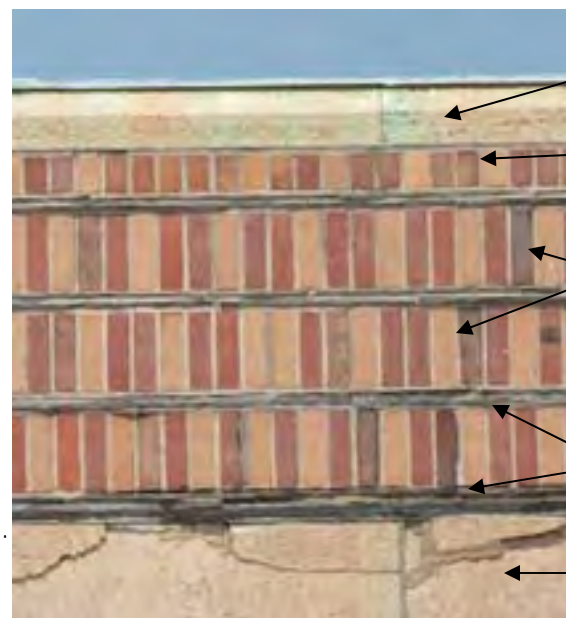

Sandstone capstone.

Barbizon Brick set in a header course.

Barbizon Brick set in soldier course.

Slate coursing.

Sandstone lintel.

Administration Building - Detail of brick at parapet.

ADMINISTRATION BUILDING PHYSICAL DESCRIPTION

Secondary Facades:

- The secondary facades are the north, east and west facades. These elevations are not generally visible from the boardwalk or beach or accessible to the general public.
- The secondary facades are constructed of Barbizon brick set in an American common bond: five rows of stretcher brick separated by a single row of headers.
- A single wide band of sandstone wraps around the building just below the top of the second story windows. The parapet above the sandstone is called out with three courses of soldier brick capped with a single row of headers. The detail mimics the parapet treatment on the primary facades. As on the primary facades the decorative brick work is topped with a sandstone cap stone.
- All of the windows feature sandstone sills and steel lintels faced with brick.
- The windows were originally wood double hung windows. The majority of the windows were four-over-four. Exceptions included bathroom windows, basement windows and stair hall windows. The windows are currently four-over-four metal replacement windows. The original transparent glass has been replaced with tinted reflective glass.
- The exterior doors were originally wood panel doors with eight lights. The original doors have all been replaced with secure hollow metal doors.
- The east façade also features two brick grilles on the first floor next to the entrance. Stone or brick grilles are a common detail used throughout Jones Beach.



Administration Building, East Façade 2013



Administration Building, East Façade 2013



Alley between Administration Building and Boardwalk Café.
Note the area is shielded from the boardwalk by the wood



Administration Building under construction c. 1950-1951.

**ADMINISTRATION BUILDING
SUMMARY OF EXISTING CONDITIONS**

Overall the Administration Building is in fair condition. Deterioration, however, is apparent in multiple locations:

- **Stress Cracks.** The sandstone lintels on the primary facades exhibit multiple stress fractures. Some of the lintels have been patched while other areas appear ready to fall. These areas should be inspected more thoroughly. 30% of the lintels on the boardwalk facades are cracked.
- **Rust Jacking.** Expansion of the steel as it corrodes has also resulted the loss of original material (brick lintels) on the secondary facades. The replacement brick is not a great match to the historic Barbizon brick. 100% of the brick lintels have been replaced.
- **Water Inflation.** The sandstone coursing along the parapet displays evidence of prolonged water infiltration at the roof level. Poor or insufficient flashing has probably allowed water to enter the wall cavity resulting in staining of the sandstone. Excess moisture in the walls has also resulted in areas of efflorescence.
- **Sandblasting.** Erosion of the sandstone by 'sandblasting' from the beach sand. Unfortunately the strong winds off the ocean often blow sand at the buildings lining the beach. The velocity wind and the coarseness of the sand results in a sandblasting effect on the masonry. Over time the masonry becomes pitted and eroded. This is evident on many of the stone units on the south façade. While the units are pitted they are still in stable condition. Eventually severely eroded sandstone units will require replacement. 10% of the sandstone block are severely eroded.



South Façade: Cracking in sandstone lintels.



South Façade: Sandstone pitting—typical condition.

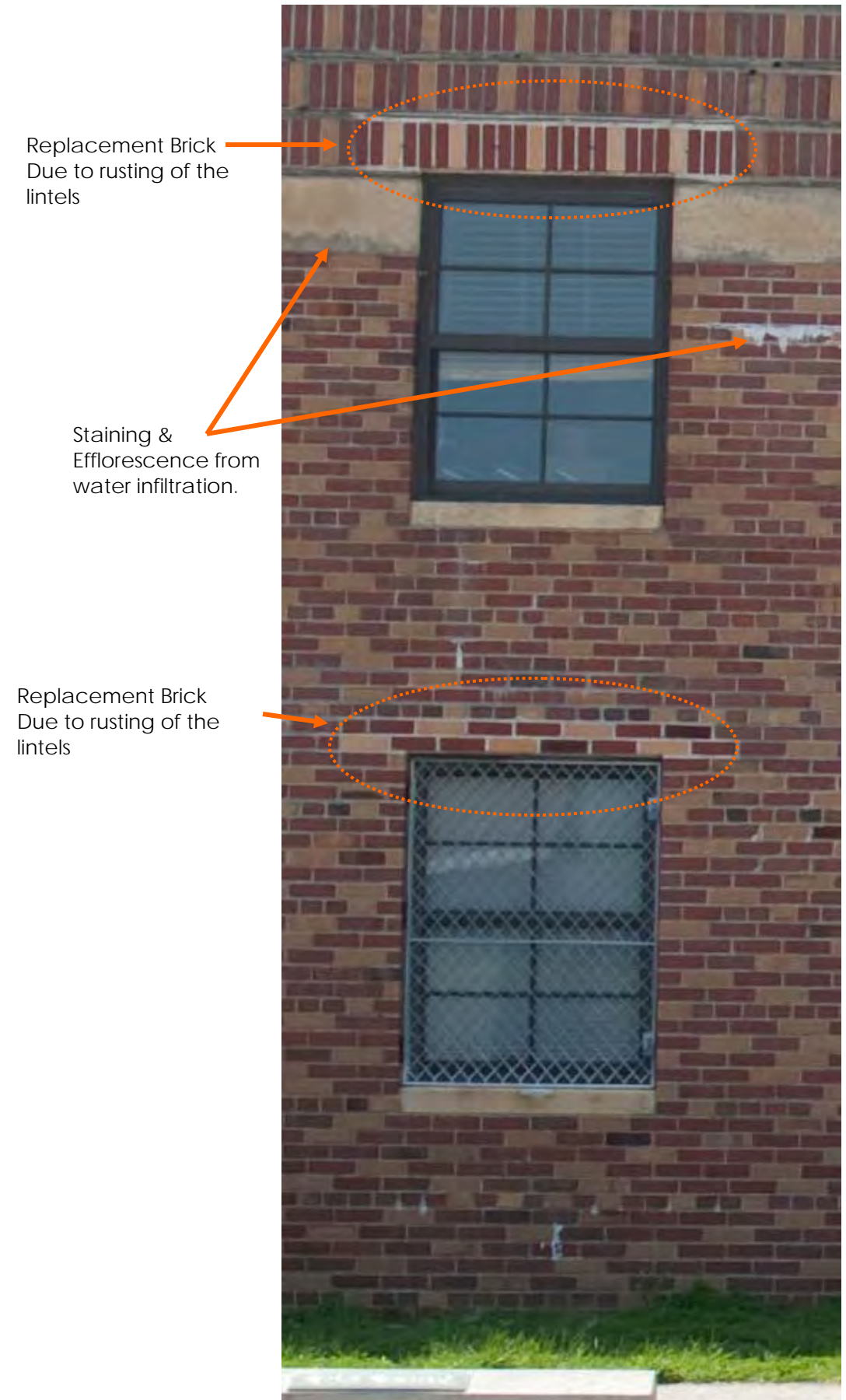

Replacement Brick
Due to rusting of the
lintels

Staining &
Efflorescence from
water infiltration.

Replacement Brick
Due to rusting of the
lintels

ADMINISTRATION BUILDING: USE, SIGNIFICANCE & PRESERVATION

SPACE & USE

Recommendation:

The building currently maintains its historic use and continues to functioning well. The building provides critical space for a public interaction with Park staff at a central location within the Park. It is recommended that the building continue to serve as administration offices with public amenities.

| Space | Location | Sq. Foot (Aprox.) |
|-------------|---------------------|-------------------|
| Offices: | Ground & 2nd Floors | 2875 sq. ft. |
| Storage: | Ground Level | 1770 sq. ft. |
| Beach Shop: | Boardwalk Level | 1000 sq. ft. |
| Reception: | Boardwalk Level | 525 sq. ft. |
| First Aide: | Boardwalk Level | 330 sq. ft. |
| Restrooms: | Boardwalk Level | 400 sq. ft. |

| Space | Historic Use | Current |
|-------------|-------------------------|------------------|
| Offices: | <i>Administration</i> | <i>No Change</i> |
| Storage: | <i>Storage</i> | <i>No Change</i> |
| Beach Shop: | <i>Concession—shop</i> | <i>No Change</i> |
| Reception: | <i>Reception</i> | <i>No Change</i> |
| First Aide: | <i>First Aid Office</i> | <i>No Change</i> |
| Restrooms: | <i>Facilities</i> | <i>No Change</i> |

SIGNIFICANCE

The Administration Building is significant:

1. As an important component of the formal Beaux Arts plan of Jones Beach State Park. The specific location reinforces the strong axial component of the Boardwalk.
2. For its architectural design. The building reflects careful thought regarding use, layout, materials and ornamental design. These elements are skillfully used together to create a structure that works individually and as part of the overall park design.

Significant Elements include:

1. **Materials.** The use of specific materials was consistent throughout Jones Beach and helped maintain a sense of unity through the large park. Important materials uses at the Administration Building include Barbizon Brick, buff colored sandstone and grey slate trim.
2. **Design Elements.** Important design elements include the tooling and coursing of the sandstone, the coursing of the brick, and the pattern of the openings. The canvas awnings on the primary facades are also a significant feature.
3. **Function & Design.** The relationship between design and function is significant. The level of ornament on the building reflects its use. The highly ornamented section along the boardwalk reflects a public use while the relative simple rear facades reflects the non-public access or use.

Period of Significance: 1950-1951 (Original Design).

TREATMENT

Recommendations: Rehabilitation

Retention and preservation of Historic Materials

1. The impact of alterations, repairs and even code upgrades should be weighed in terms of their effect on historic fabric. Code requirements specifically the ability to meet health and safety, energy codes and ADA requirements should be addressed without damaging historic spaces, features or finishes.

Repair of Historic Materials and Features

1. Many important features are threatened by deterioration including the Ohio sandstone and Barbizon brick. When necessary deteriorated fabric should be replaced in kind. While replacing in kind is an option the primary goal should be the preservation of historic fabric.

Replacement of Missing Historic Features

1. The Administration Building maintains much of its original fabric and ornamentation. Where possible historic documentation should be used to replicate losses due to deterioration or alteration. Missing or altered elements include:
 - **Windows:** The existing windows should be replaced as their lifespan comes to an end with windows that replicate the historic appearance of the original windows. Alternative materials may be selected to increase durability but the design should replicate the historic appearance of the windows. The reflective quality of the glass should also match the historic appearance.
 - **Doors:** The existing doors should be replaced as their lifespan comes to an end with doors that replicate the historic appearance of the original doors. Alternative materials may be selected to increase durability but the design should replicate the historic appearance of the doors.

ADMINISTRATION BUILDING

HISTORIC PHOTOGRAPHS



ADMINISTRATION BUILDING UNDER CONSTRUCTION C.1950-1951.



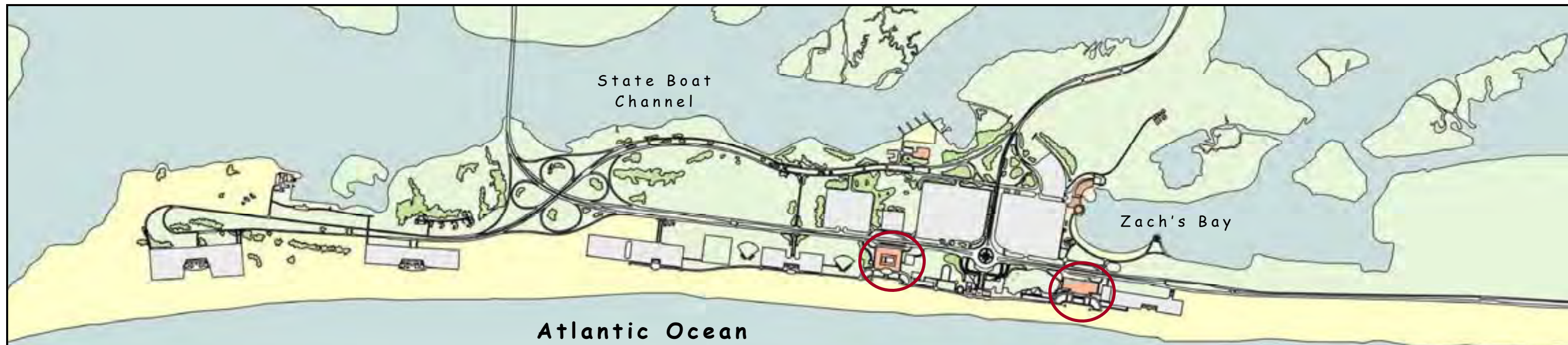

Zone 2: The Bathhouses
Jones Beach State Park
Wantagh, Long Island
New York

New York State Office of Parks,
Recreation & Historic Preservation



Zone 2—Bathhouses

The Bathhouses were the envisioned and designed to be the 'clubhouses' of Jones Beach. Comparable in scale and ornamentation the grandeur of the Parks itself. The Bathhouses recalled upon the great bathhouses of antiquity, reinterpreted and expanded. New uses were seamlessly incorporated with traditional functions providing modern facilities & amenities. The buildings were designed to be part of the experience—entertaining with whimsical and exotic layers of architectural detail.

The East & West Bathhouse are two of the most significant and impressive buildings at Jones Beach. The buildings are the anchors of the formal Beaux Art plan of the Park. Each of the massive, complex bathhouse was skillfully designed to present a unified and harmonious façade. The architects relied on Art Deco design vocabularies & common materials to create a distinctive style unique to Jones Beach. Each Bathhouse was designed to accommodate thousands of patrons providing amenities ranging from locker room, bathrooms, swimming pools, cafes to formal dining.

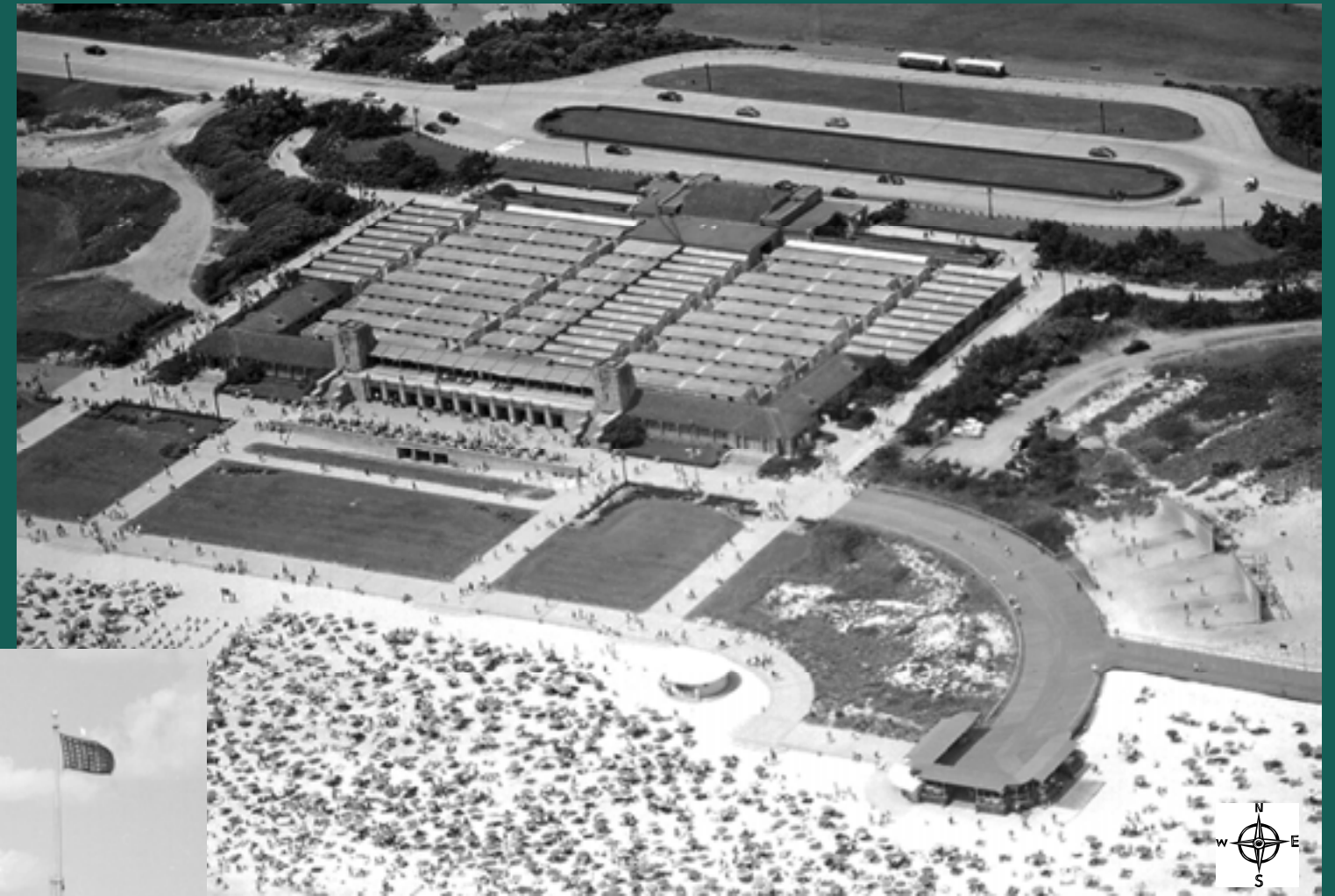

Aerial View: East Bathhouse 1950's



South Elevation: West Bathhouse 1950's

Bathhouse Zone Chronology of Development

- 1929-30 Construction & Opening of East Bathhouse (EBH)
- 1930-31 Construction & Opening of West Bathhouse (WBH)
- 1942 EBH closed (WWII)
- 1943 WBH "Marine Dining Room" converted to USO Lounge (WWII)
- 1944-45 EBH reopened
- 1950-55 Major alterations at the WBH
- 1965-67 Major alteration to the EBH
- 1970 Improvements to sun shelter at EBH
- 1970's & 1980's Masonry Alterations at WBH
- 2009 EBH closed



East Bathhouse, 1950's

West Bathhouse, 1940's



Zone 2 The Bathhouses

- East Bathhouse
- West Bathhouse

CHARACTERISTICS

- The Bathhouse zone includes the two major Bathhouses that flank the Central Mall, the East and West Bathhouses.
- The Bathhouses are key components of the Beaux Arts design of the Park. Symmetry, materials, scale and architectural style were used to unify the buildings.
- The basic design of each bathhouse is identical, a north entrance building on Ocean Parkway, an impressive south building facing the beach and a central courtyard set between the two building. A long one-story brick screen wall was used to connect the two buildings and enclose the courtyard.
- Each building featured a high style beach (south) facade of sandstone accented with brick. The north facades were treated much more simply.
- The buildings feature a similar layout, a north entrance building, a central courtyard area and a large south building.
- Each building presents a single story entrance building on Ocean Parkway. The low horizontal north facades are accented by square masonry towers. The north buildings feature loggias, wood screen ticket windows and brick lobbies.
- The high style south facades are significantly more ornate and grand. These facades are two stories with large windows, towers & decorative stonework.
- The buildings also feature large plazas that tie the buildings to the Boardwalk and beach.
- While the buildings feature many of the same defining characteristics, each building is also unique. The East Bathhouse was completed first and in many ways was the design foundation for the bigger & grander West Bathhouse.

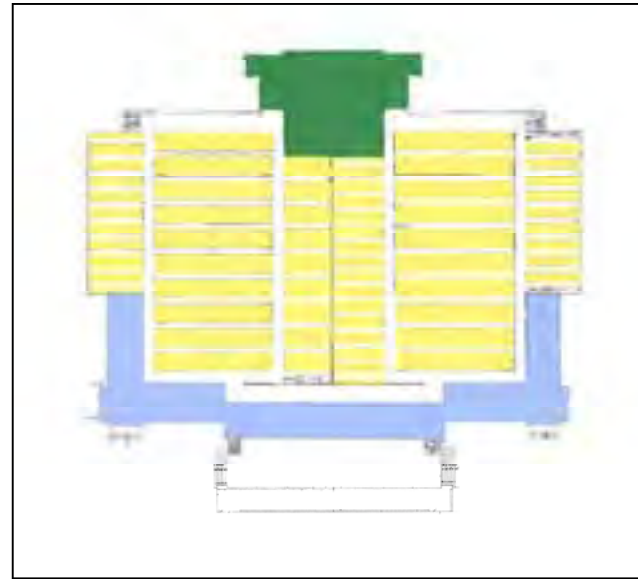

East Bathhouse, 1929
115,000 sq ft

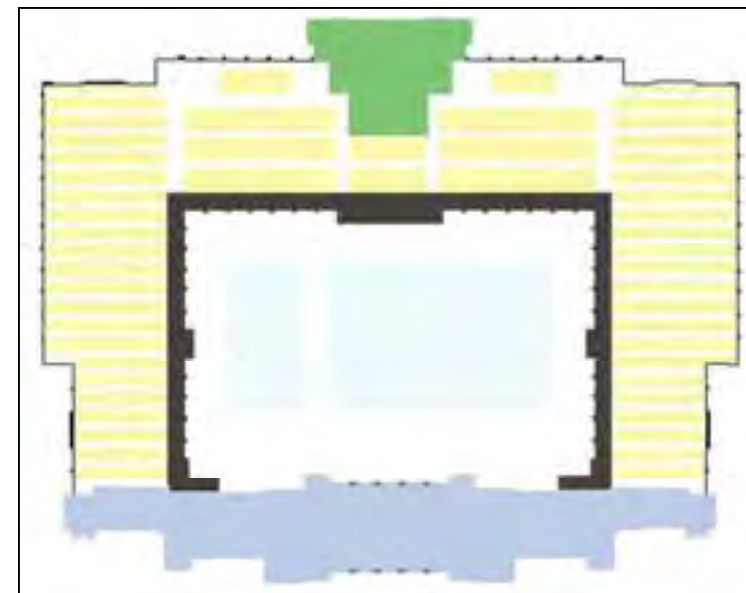

West Bathhouse, 1930
170,000 sq ft

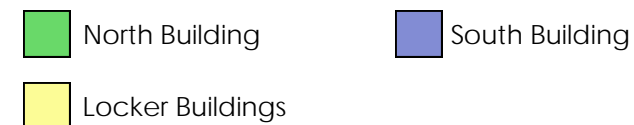

Zone 2—The Bathhouses

Chronology of Development & Use:

- The Bathhouses were originally designed for a different era, when a trip to Jones Beach included swimming, sun-bathing, play, lunch & dinner and followed by dancing/live music. The 1930's and 40's were a more formal time when beach patrons were required to change from street clothes to beach clothes or from bathing suits to dinner attire. Wearing your suit under you clothes, changing in your car etc. was not allowed. The Bathhouses provided hundreds of lockers and changing rooms to accommodate this need. The Bathhouses also provided entertainment; pools, terraces, soda fountains, formal dining & band shells.
- In the post-WWII era, the way people used Jones Beach changed and the Bathhouses were changed to meet these new uses. Formal dining was no longer popular, so cafeteria dining was offered to young families with children. The number of changing rooms and lockers were greatly reduced, and a central courtyard with a pool was added to the East Bathhouse. Other significant changes were also undertaken to accommodate the vast crowds and changing demands.
- Following the major changes in the 1950's and 60's most changes at the Bathhouse were related continuing declines in use and deterioration. Deterioration and deferred maintenance has resulted in loss of historic fabric both bathhouse.



East Bathhouse,
North Elevation 1940's



East Bathhouse,
North Elevation 2013

throughout the exterior and interior of



West Bathhouse, Marine Dining Room 1930's

West Bathhouse, Marine Dining Room 1950's



East Bathhouse,
Aerial View of courtyard 1930's



East Bathhouse,
Aerial View of courtyard 1970's

**Zone 2—The Bathhouses
Existing Conditions**

The Bathhouses

The integrity of the Bathhouses has slowly been eroded by unsympathetic/inappropriate additions and deterioration.

Inappropriate Alterations

- Replacement of windows and doors.
- Infill of window and door openings.
- Removal of canvas awning on viewing decks.
- Removal of Art Deco ornamentation.
- Removal of significant trim elements.
- Reconfiguration/alteration of significant historic spaces.
- Replacement of historic materials (Barbizon Brick, sandstone, slate and tile) with inappropriate materials.
- Introduction of commercial brands (signage, lighting, style) into historic spaces.

Deterioration

- Water infiltration had resulted in the loss of original historic materials including Barbizon brick, sandstone, cast stone & wood.
- Water infiltration has also resulted in the loss or damage to interior finishes including varnished wood, stucco and plaster.
- Historic paving/flooring materials (slate and terrazzo) have been damaged by excessive wear, settlement and inappropriate cleaning methods/materials.



East Bathhouse, South Elevation 2013.
Note: removal of awnings & partial enclosure of sundeck.



West Bathhouse, Former Marine Dining Room (half) 2009.
Note: Friendly's Concession and division of space.



West Bathhouse, South Elevation of Courtyard 2009.
Note: infill of ground floor bays and second story windows.



East Bathhouse, Loggia/Lobby 2013—Note: Ceiling failure.



West Bathhouse, South Elevation 2009—Note: Cast Stone failure.



West Bathhouse, South Elevation 2009.
Note: collapse of lintels over doors.

Inappropriate Alterations

Deterioration

ZONE 2 THE BATHHOUSES: USE, SIGNIFICANCE & PRESERVATION

SPACE & USE

Recommendation:The East & West Bathhouses are very large structures that have functioned from a variety of uses since the 1930's. The buildings are currently underutilized and could be successfully adaptively reused.

| Building | 1930's | 1967 –Present |
|----------------|-----------------|------------------|
| East Bathhouse | 115,000 sq. ft. | 160,000 sq. ft. |
| Building | Historic Use | Current (2013) |
| East Bathhouse | Admittance | Same |
| | Lockers | Same—less |
| | Changing Rooms | Same—less |
| | Restrooms | Same |
| | Viewing Deck | Same—enclosed |
| | Promenade | Exhibit/Admin. |
| | - | Pool & Pool Deck |

| Building | 1930's | Present |
|----------------|------------------|------------------|
| West Bathhouse | 170,000 sq. ft. | 170,000 sq. ft. |
| Building | Historic Use | Current (2013) |
| West Bathhouse | Admittance | Same |
| | Lockers | Same/Storage |
| | Changing Rooms | Same/Storage |
| | Restrooms | Same |
| | Viewing Deck | Same—less |
| | Formal Dining | Ice Cream |
| | - | Meeting Space |
| | Pool & Pool Deck | Pool & Pool Deck |
| | Café | Café |

SIGNIFICANCE

The Bathhouses are significant:

1. As an important component of the formal Beaux Arts plan of Jones Beach State Park.
2. For their association with Robert Moses.
3. For its architectural design. The buildings reflect careful thought regarding use, layout, materials and design. These elements are skillfully used together to create a harmonious and unified buildings.

Significant Elements include:

1. **Plan/Layout.** Spatial organization and circulation are completely intertwined at the Bathhouses. Circulation routes were carefully designed to take advantage of space uses in a logical and sequential manner. Spatial organization was also used to visually connect spaces, drawing visitors from one use to the next.
2. **Function/Use.** The Bathhouses functioned way beyond bathhouse, becoming centers for entertainment. Character defining spaces include terraces, lobbies, courtyards, dining rooms and changing areas.
3. **Materials.** The use of specific materials was consistent throughout Jones Beach and helped maintain a sense of unity through the large park. Important materials used include Barbizon Brick, sandstone, wood, copper and cast stone.
4. **Architectural Style:** The use of the unique Jones Beach style featuring a combination of the Moorish and Art Deco characteristics.

Period of Significance: 1930-1951

TREATMENT

Recommendations: Rehabilitation

Retention and preservation of Historic Materials

1. The impact of alterations, repairs and additions should be weighed of their effect on the Park design and historic fabric. Code requirements specifically the ability to meet health and safety, energy codes, and ADA requirements should be addressed without damaging historic spaces, features or finishes.

Repair of Historic Materials and Features

1. Many important features are threatened by deterioration including the Ohio sandstone and Barbizon brick. When necessary deteriorated fabric should be replaced in kind. While replacing in kind is an option the primary goal should be the preservation of historic fabric.

Replacement of Missing Historic Features

1. The Bathhouses maintains much of their original fabric and ornamentation. Where possible historic documentation should be used to replicate losses due to deterioration or alteration.

Restoration of Major Historic Features/Spaces

1. EBH: Exterior facades, Loggia, North Lobby, South Terrace, Lighting, Signage, Awnings.
2. WBH: Exterior facades, Marine Dining, North Lobby, Original circulation at beach/courtyard, South Lobbies, Lighting, Signage, Awnings.

ZONE 2: THE BATHHOUSES
EAST BATHHOUSE



**EAST BATHHOUSE
CHRONOLOGY OF DEVELOPMENT & USE**

- The East Bathhouse was designed by Herbert Magoon, AIA in 1929-1930.
- The drawings were approved & signed by Architect/Engineer W. Earle Andrews.
- The East Bathhouse was the first major building completed at Jones Beach. The opening ceremony for Jones Beach was held at the East Bathhouse on August 4th, 1929. The building was completed and open in the spring of 1930.
- The building was originally 115,000 sq ft (approx) including a vast locker/changing area, an administration building and an impressive south building along the beach. The south building featured sun terraces, concessions and restrooms.
- In 1967-70, the building underwent a major reconstruction. The building was enlarged to over 150,000 square feet with addition of new wings on the east and west. The plan of the building was drastically altered.
- Significant alterations to the building design and fabric were also undertaken. The canvas awning was replaced with a permanent aluminum structure with a corrugated fiberglass roof, door and window were replaced & ornamental trim elements were removed or covered.
- Over the last 30 years, changes in building use has resulted in the disuse and closure of sections of the building. These spaces are now suffering from neglect and deterioration.
- In 2009, the East Bathhouse was primarily closed due to budget constraints.



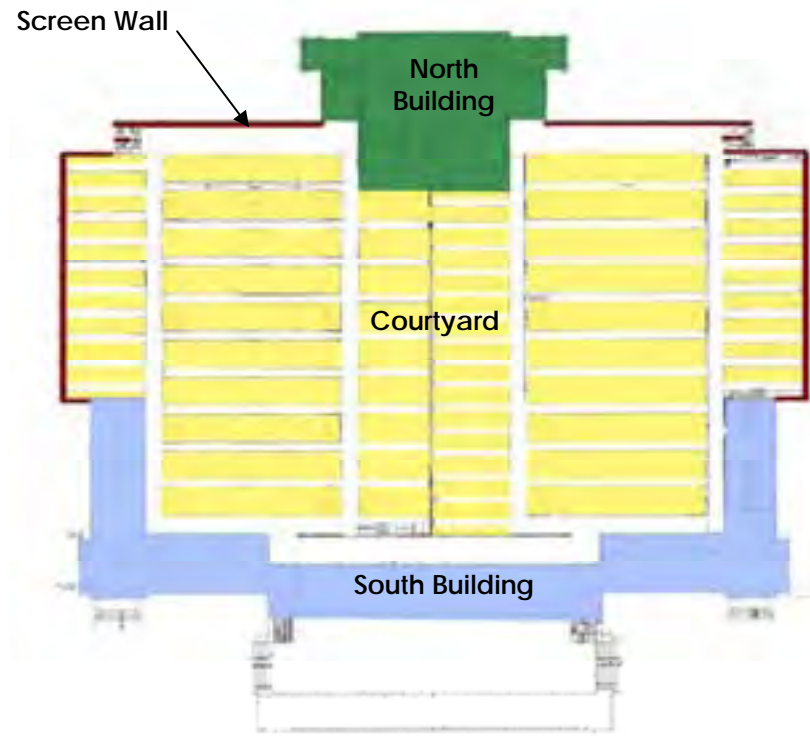

East Bathhouse, c1929-1966
Floor Plan



West Bathhouse—cabana building (1930's). A historic image on the changing area in the East Bathhouse was not found. Examination of the original drawings of the EBH & WBH, however, indicate that the buildings were very similar.

EAST BATHHOUSE (1929-1966)
CHRONOLOGY OF DEVELOPMENT & USE

- The EBH was designed as a massive multipurpose structure. The building included three primary sections; the north entrance building, a central courtyard and the south building. The central courtyard was enclosed with a brick screen wall. This wall connected the north and south buildings and screened the courtyard from view.
- The **North Building** was the primary public entrance to the EBH. This building was located on Ocean Parkway and had space allocated for ticket counters, rentals, valuables storage and information. The space also provided the primary entrance to the changing rooms.
- The **Courtyard** was located at the center of the building and featured hundreds of changing rooms, showers and lockers. The space was open (no roof) and the individual changing rooms were housed in rows of cabana style buildings. The rows of open buildings ran perpendicular to the brick screen walls that enclosed the courtyard. The roofs of the cabana buildings was just below the capstones of the screen wall, shielding the structures from view.
- The **South Building** was far larger and grander than the rest of the structure. The primary façade overlooks the ocean and featured a long central promenade that ran the length of the building (east-west) on the first floor. A long canopy covered sun bathing/viewing terrace was located on the second floor. Low one-story, cross-gabled wings extended out from the main façade and wrapped around the outer walls of the building. A large raised terrace is set in front of the building. The interior of the building was used for concessions, restrooms and viewing.



East Bathhouse,
North Building c.1947



East Bathhouse,
South Building c.1947

EBH NORTH BUILDING— (1930-66)

DESCRIPTION

- The North building of the EBH features a low horizontal profile along Ocean Parkway.
- A deep loggia runs along the front of the building.
- The central five bays of the building are set between two square towers of Ohio sandstone. The bays are defined by sandstone piers that extend through the roof line and are capped with Art Deco lanterns. Paired flag poles extend up from a recessed channel in the face of the towers. The flag poles originally features bronze strap work and decorative bronze finials.
- Three additional bays are set on the outside of each tower extending the length of the loggia. The roof is supported by sandstone piers and the simple wood cornice features paired wooden brackets.
- The central block of the building originally featured a wood shingled hipped roof. The towers and loggia had flat roofs.
- The building walls under the loggia were primarily Barbizon brick with cast stone, wood or sandstone trim. This includes the interior face of the sandstone towers. The ceiling was varnished wood.
- The interior/lobby of the north building was separated from the loggia by an open wood screen and a row of ticket booths. Copper screening was used to keep birds and insects out of the lobby. The finish of the ticket booths and wood screening is unknown at this time.
- The ticket booths featured wood posts with decorative finials and Barbizon brick set in decorative patterns.
- Each bay under the loggia was originally lit with custom designed Art Deco chandeliers. Decorative wood grilles were used to vent the ceiling of the towers.
- The towers featured decorative cast stone window grilles to allow additional natural light to penetrate the loggia. On the interior the towers had recessed areas for phone booths.
- The brick screen wall that encloses the courtyard is set back from the main façade and extends 120' to the east and west. The one-story wall is constructed on Barbizon brick and features battered brick piers at regular intervals. Decorative drinking fountains were also built into the wall on each façade. Opening in the wall featured medieval style wood gates with decorative iron strap work.

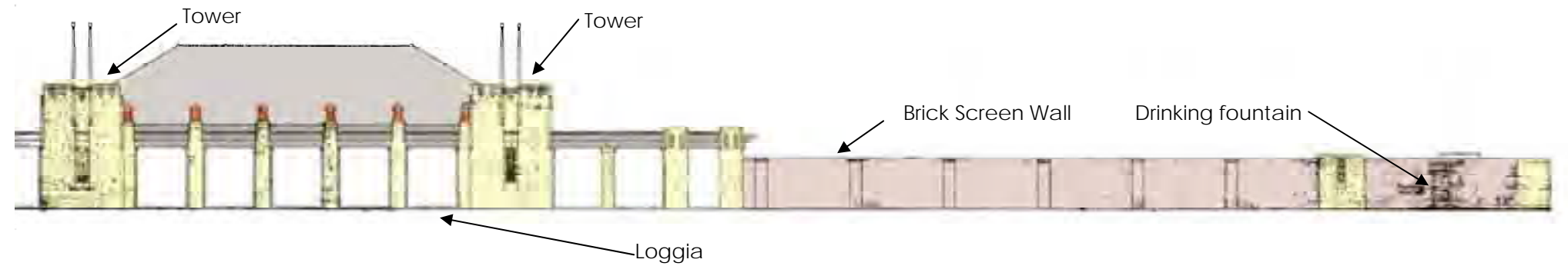

Interior of Loggia: Cast stone screen & telephone booths. (2013)



Interior of Loggia: Ticket Windows & wood screen. (2013)



North Building, c 1947

Original drawing of lantern on pier.

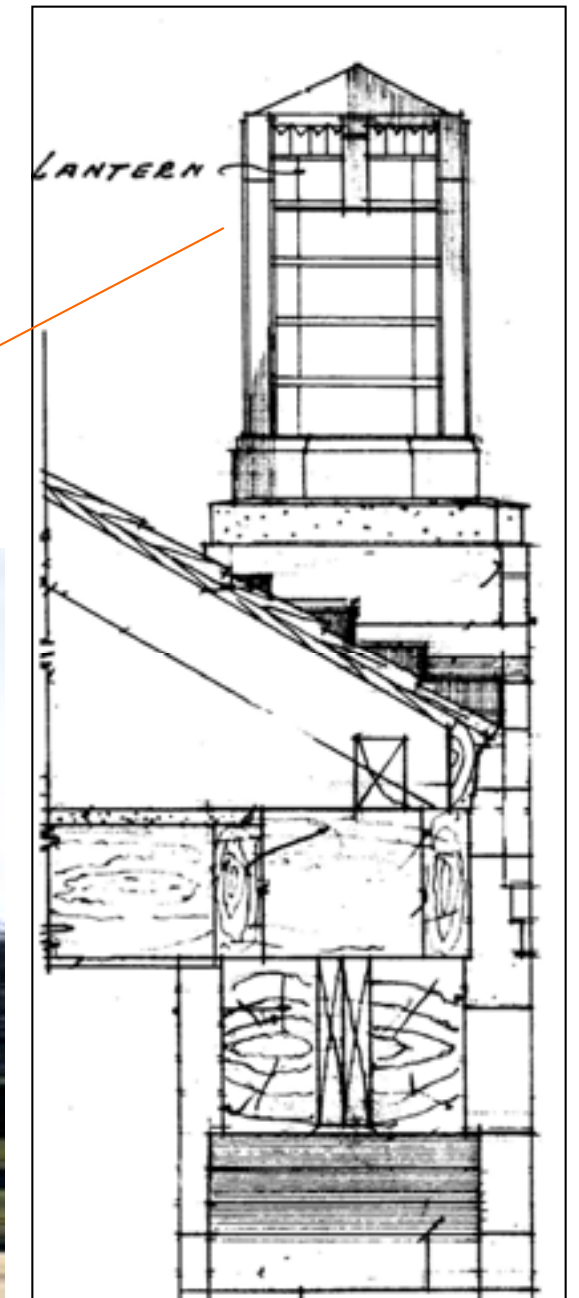

EBH NORTH BUILDING— (1929-66)

INTERIOR

- A one-story sandstone loggia runs the length of the building on the north façade.
- The loggia opens into the main lobby. A wood screen with ticket booths divides the space between the loggia and the lobby. The wood screen was varnished and featured an alternating pattern of balusters. Copper screening was originally used on the interior of the wood screen to keep insects and birds out of the lobby.
- The interior of the lobby featured durable materials and finishes because the space was partly open to the elements.
- The interior of the lobby features masonry walls of Barbizon brick set in decorative patterns, a concrete floor and varnished wood ceiling.
- Custom designed individual wood ventilation grilles with nautical themes were set in the ceiling.
- Wooded service counters were set along the sides and at the back of the lobby. The main service counter was at the back of the lobby.
- The lobby originally provided multiple access routes to the changing rooms at the center of the EBH.

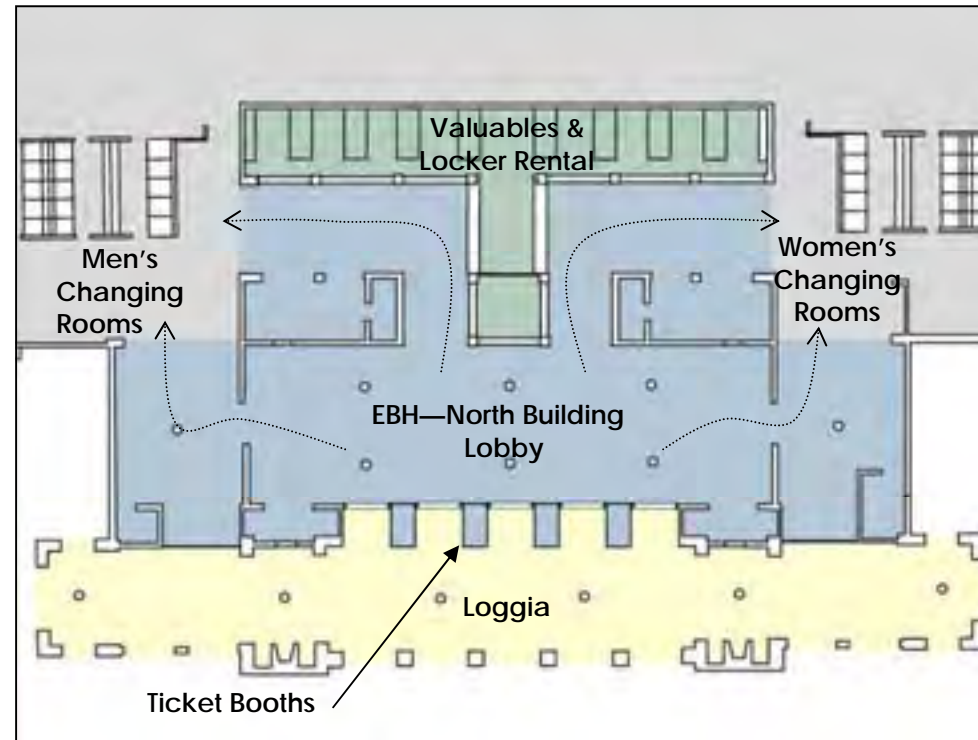

Interior of North Building (1929-66)

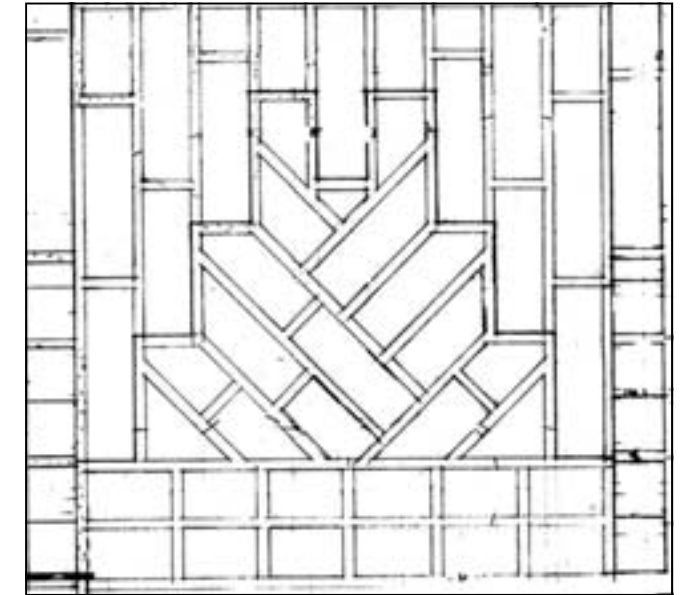

Original drawing of brick wall detail (North lobby).

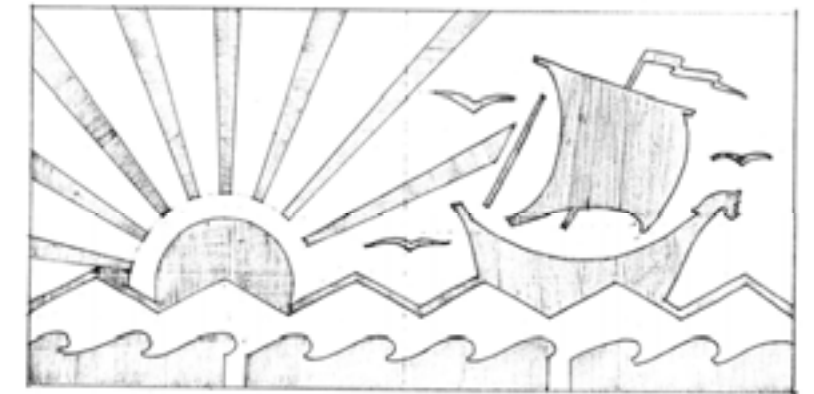

F.S. PANELS Nos 3

Original drawing of wood ceiling grille (North lobby).

East Bathhouse, c1950
South Elevation



EBH SOUTH BUILDING (1929-66)

DESCRIPTION

EXTERIOR

- The East Bathhouse featured an impressive south façade on the beach. The building was executed in the Jones Beach style featuring primarily Art Deco design elements. The building resembled a larger than life sandcastle rising out of the sand. The square towers and rustic stonework gives the building a presence and timeless character. The canvas awnings, wood railings and carved finials lent a whimsical note to the building.
- Overall the south façade of the EBH is very horizontal. The two square towers are linked by a series of horizontal lines created by the roof, the awnings and the railings. The low horizontal nature of the building is reinforced by the terrace walls, the one-story flanking wings and the bands of windows.
- The stone piers that support the terrace and delineate the façade extend up through the second floor railing. The second floor wood railing featured flat spindles that recall the wood screen on the north façade. The finials on the wood awning posts match those used on the ticket booths at the entrance (north building).
- The wide open terrace in front of the building featured umbrella tables. The canvas of the umbrellas coordinated with the building's second floor sundeck awning. The terrace was enclosed with a sandstone wall that extended out from the building. Slate steps lead up from the Bathhouse plaza to the terrace.
- One-story wings flank the central section of the building. The south facades are divided into bays by wood posts with simplified cornices. Each bay features bands of small square windows with decorative wood paneling below the windows. The large number of small lites provided abundant natural illumination for the promenade.
- At the far end each wing features a cross-hipped section that provided entrances to the restrooms or the central promenade. The entrances were called out by paired wood posts with finial caps that penetrated the roof line.
- Each tower originally featured a clock, the west tower featured a time clock while the east tower featured a tide clock. The lettering and numerals were bronze and the hands were wood.
- The south façade of the building is constructed primarily of Ohio sandstone with brick (Barbizon), cast stone, limestone and wood accents.



East Bathhouse, Original drawing
detail of south tower (1929)



East Bathhouse, Detail of south
tower (2013)



Concession counter in East Promenade, 1939

EBH SOUTH BUILDING (1929-66)

DESCRIPTION

INTERIOR

- The interior of the East Bathhouse was originally composed of a long promenade that ran the length of the building. The idea of a promenade continued the nautical theme of the Park, drawing on the promenade deck on a ship. The one-story promenade extended from the central section of the building through the flanking wings.
- The promenade was at its widest, longest and highest at the central section of the building. Here the promenade runs under the second floor sundeck and was open to the elements of the south façade. The interior finishes were designed to survive the elements, the crowds and maintain a common pallet throughout the EBH. The north wall was Barbizon brick, the ceilings featured exposed rafters with tongue and groove board and concrete floors. Decorative water fountains with bluestone bowls were built into the rear wall of the promenade.
- The East and West promenades were enclosed on the south elevation with a wood screen wall. The wall featured large rows of windows that allowed natural light to flood the space while providing protection from the wind. The bays were divided by square wood posts with abstract capitals. The exterior wood panels below the windows featured decorative trim.
- The East and West promenades also featured concession stands along the rear (north) wall. Each concession featured a long marble topped service counter.
- Small 'satellite' concession booths were also located in the ground floor of the towers with marble service counters on the promenade sides.
- The second floor sun deck featured an open terrace. A canvas awning covered the rear of the terrace. The underside of the canvas and the awning structure was exposed.

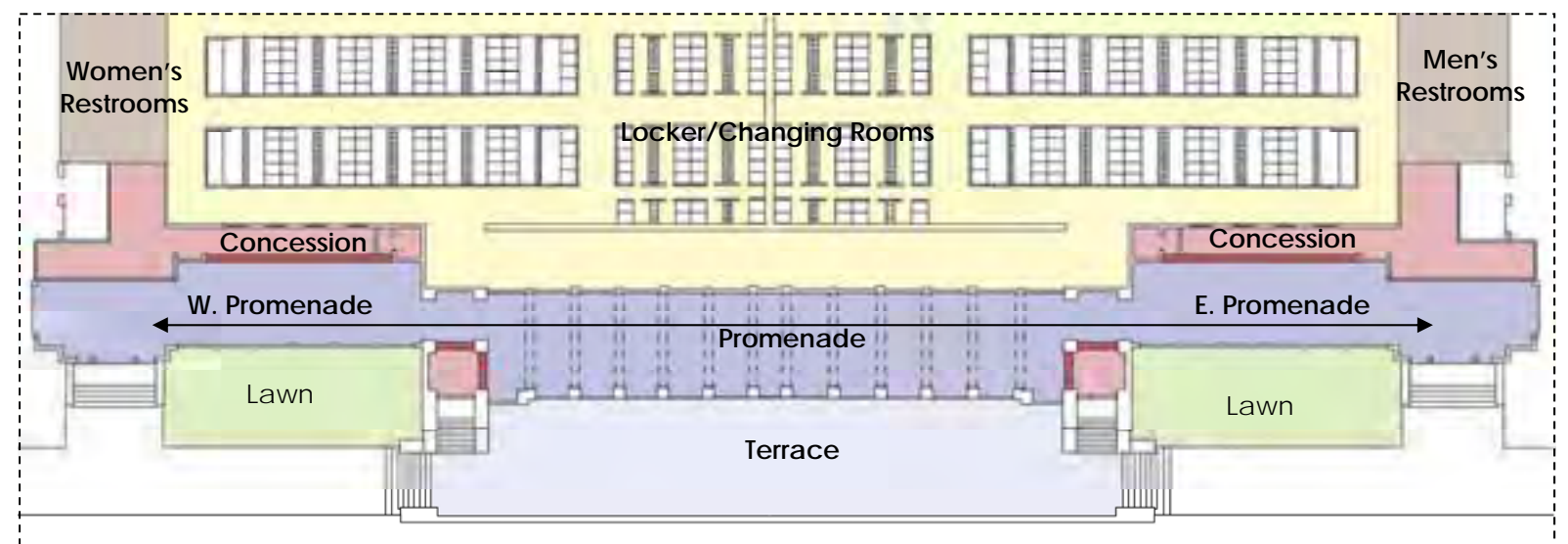

Detail of South Building—1st Floor Plan

EAST BATHHOUSE (1967-70)

CHRONOLOGY OF DEVELOPMENT & USE

The EBH underwent a major 'restoration' between 1967-1970. As with many of the buildings at Jones Beach, the social and demographic changes in the post-WWII era greatly effected how the structure was used. The vast changing rooms were no longer required and time and neglect had left the building in poor condition. The 1967-70 restoration greatly altered the structure:

- The central block of the building was completely demolished. A new courtyard was created at the center featuring a large pool with a diving area and smaller wading pool. Sheltered areas were provide at the north and south of the courtyard under concrete terraces. The upper terrace was open (no awnings) for sun bathing.
- New enclosures were added outside the original building footprint to the east and west to house the new changing areas. The original EBH changing room layout was used as a model for the new changing areas: rows of cabana style building were set perpendicular to the brick screen walls that enclosed the area.
- New screen walls were constructed to replaced the historic walls that ran along the east and west elevations of the original courtyard. The new walls were composed of a 'modern' version of Barbizon brick with a deeper color range and polished surface. The walls maintained the brick coursing, use of battered piers and cast stone cap stones.
- Many of the decorative lanterns, built in lighting fixtures and ornamental stone details were removed at this time.

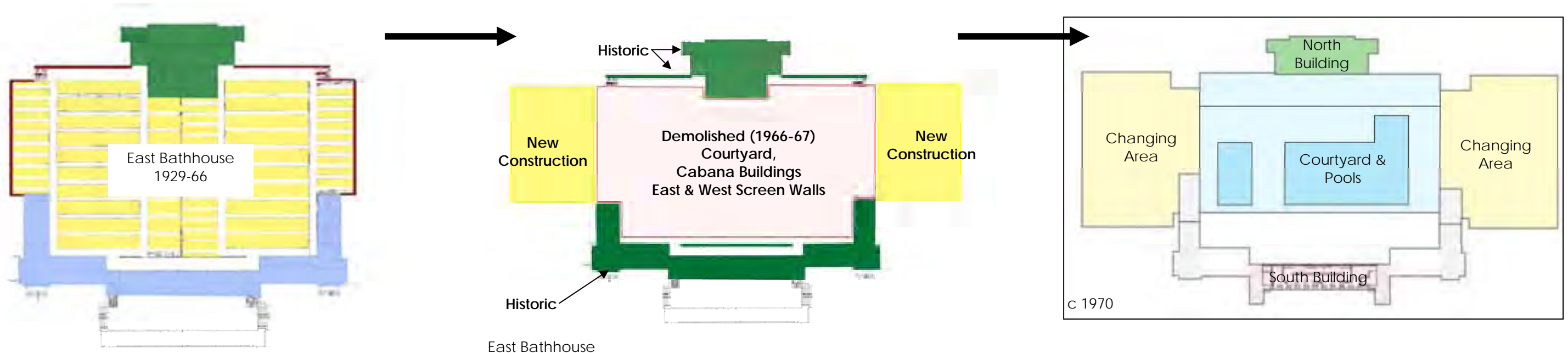

EAST BATHHOUSE (1967-70)
CHRONOLOGY OF DEVELOPMENT & USE

- The south building was significantly altered. On the interior, the building length promenade was eliminated. A new concession area was located in the center of the building. The formerly open promenade was enclosed by aluminum clad doors set between the stone piers on the south elevation. The space was also closed off from the east and west wings.
- The new pool courtyard was very austere with concrete decking and walls. Unornamented terraces overlooked the courtyard on the north and south. Life preservers were used to decorate the walls and the piers along the north and south walls were topped flagpoles with multicolor nautical style flags.

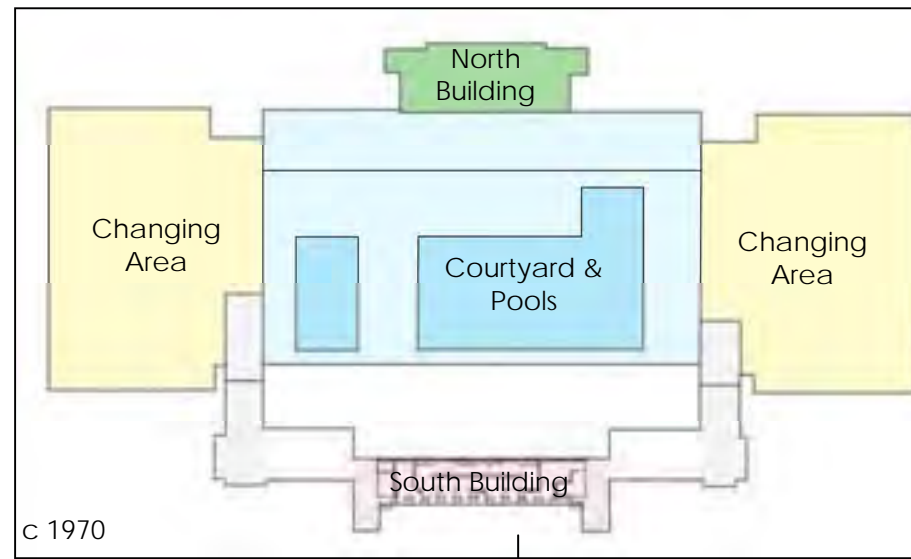

Courtyard Pool c.1970

Sketch of 1st floor of South Building—1929

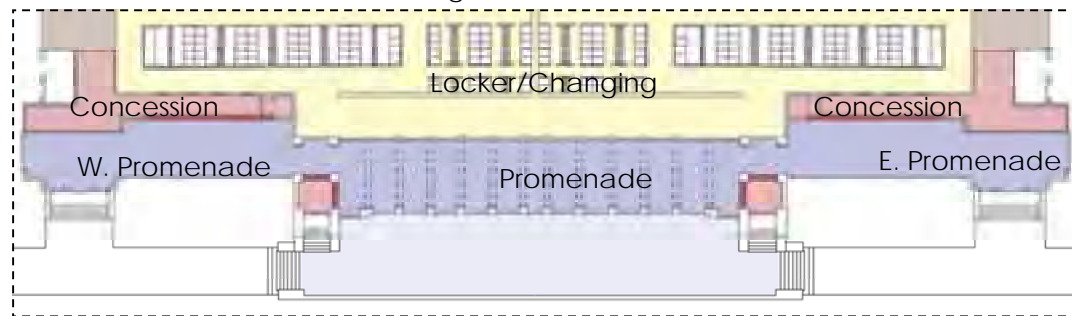

1929 to
 1967-70

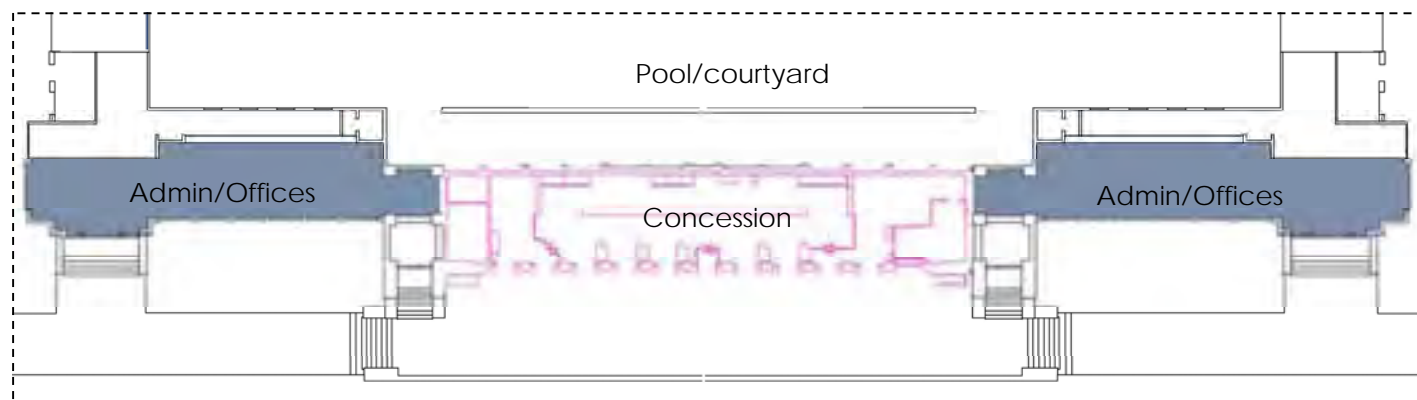

Sketch of 1st floor of South Building—post 1967



Aerial View 1970's

EBH NORTH BUILDING — (1967– PRESENT)

ALTERATIONS

- The decorative lanterns and wood flagpoles with bronze finials on the north elevation of the building were removed.
- The interior was reconfigured to provide separate access to either the new courtyard/pool or the changing rooms. New walls were constructed at various points to create new spaces or to re-direct traffic. The brick used to construct the walls was not a good match to the historic Barbizon brick.
- The long corridors behind the north screen walls were enclosed. Structural block was used to construct the north wall of the space. The top of the screen wall was enclosed with glass block.
- The fascia, ticket booths and wood screen were painted.
- The wood shingled roof was also replaced with asphalt shingled roof.
- The cabana style buildings were replaced with more permanent structures. The new buildings featured hipped roofs that extended over the brick screen wall.



North building façade (2013)



1967-70 Passage between brick screen and block wall. (2013)

EBH SOUTH BUILDING— (1967-PRESENT)

ALTERATIONS

- The original fixed frame (45°) canvas awning with scalloped valance was replaced with a grey corrugated fiberglass roof. The wood posts with decorative finials that originally supported the awning were replaced with square aluminum posts.
- The open terrace on the second floor was also partially enclosed. Glass wind screens were also installed further enclosing the space.
- The decorative wood railing was replaced with aluminum.
- The cast stone cap stones on the sandstone piers have been removed or covered with aluminum. Other decorative masonry has also been covered or removed.
- The open loggia on the first floor under the terrace was enclosed with aluminum clad doors and windows.
- The formerly glass and wood facades of the east and west promenade were fully enclosed and the interior spaces divided. The wood screen walls with blocks of windows were replaced with solid wood panels and large aluminum windows. The new windows do not match or historic configuration.
- New aluminum doors and windows were also installed throughout the building. These windows did not match the profile or configuration of the original windows.
- New brick terrace walls were also constructed in front of the promenade wings. The brick is a poor match for the historic Barbizon brick.

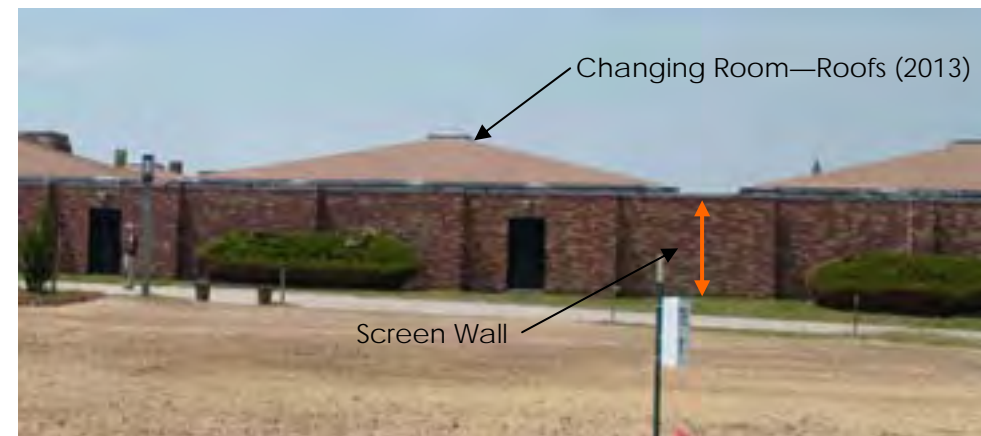

EAST BATHHOUSE

SUMMARY OF EXISTING CONDITIONS

Overall the East Bathhouse is in poor condition. Evidence of neglect, disuse and deterioration can be found throughout the building. Funding crises in last decade have further contributed to the decline of the buildings condition.

Water Inflation:

- Water infiltration is apparent at many locations throughout the building. The north building is in especially poor condition due to prolonged water infiltration at the roof level. Significant historic fabric (wood ceilings in loggia and lobby) has been lost or damaged due to roof leaks. Water has also damaged wood screens, decorative ventilation grilles and service counters.
- Damage from water infiltration can also be found in parapets, cap stones and around deteriorated flashing.

Brick Deterioration:

- The historic Barbizon brick appears to be in good condition. Later examples of the brick (70's & 80) however are in very poor condition. The bricks are cracked & spalled. Efflorescence is also a problem with the later brick.

Stone/Concrete Deterioration:

- The historic Ohio sandstone is in generally fair condition. Select sandstone blocks have weathered poorly and are spalled or cracked. Over eighty years of wind and sand erosion on the south façade has resulted in material loss.
- The slate steps on the south elevation are in poor condition. The slate blocks appear to have been improperly bedded resulting in delamination of the stone surface along the bedding planes.

Wood Trim:

- The wood fascia boards and screening on the north building features extensive paint failure.



Peeling paint on fascia of North Building.
Main public façade on Ocean Parkway.



North building ceiling deterioration (2013)



Brick Screen wall—deterioration (2013)
Bad picture to be replaced



North building concrete deterioration (2013)



Deterioration of pool lining due to disuse (2013)

EBH (1930-66)
LANDSCAPE PLAN

- The East Bathhouse featured a carefully designed landscape plan that incorporated plantings and hardscape elements. The landscape plan defined the area around the East Bathhouse and tied the area into the overall Beaux Arts Park plan. The Parterre style of landscaping used at the Central Mall area was also used around the EBH.
- The Bathhouse landscape included the pedestrian walkways that led from the parking fields on the other side of Ocean Parkway, a wide perimeter around the building on the north, east and west and the large south plaza.
- The EBH features a rectangular raised terrace along the south façade. The south wall of the terrace formed the north boundary of the south plaza. The south plaza is set between the EBH and the beach and Boardwalk/ocean. The plaza is 'embraced' by the long curved sections of the boardwalk that extended out from the EBH on the east and west. The curved sections of boardwalk terminated in awning covered boardwalk shelters. Beach umbrella rental stands were incorporated into the shelters.
- The plaza was divided into five sections. The central section extended directly out from the terrace and featured a wide expanse of lawn extending down to the beach. The two flanking sections of plaza also featured closely mown lawn. The sections to the east and west however, transitioned from lawn to beach grass.
- The landscape close to the building featured sections of lawn, pathways and sharply defined hedges. The hedges become larger and more wild as they extended away from the building.

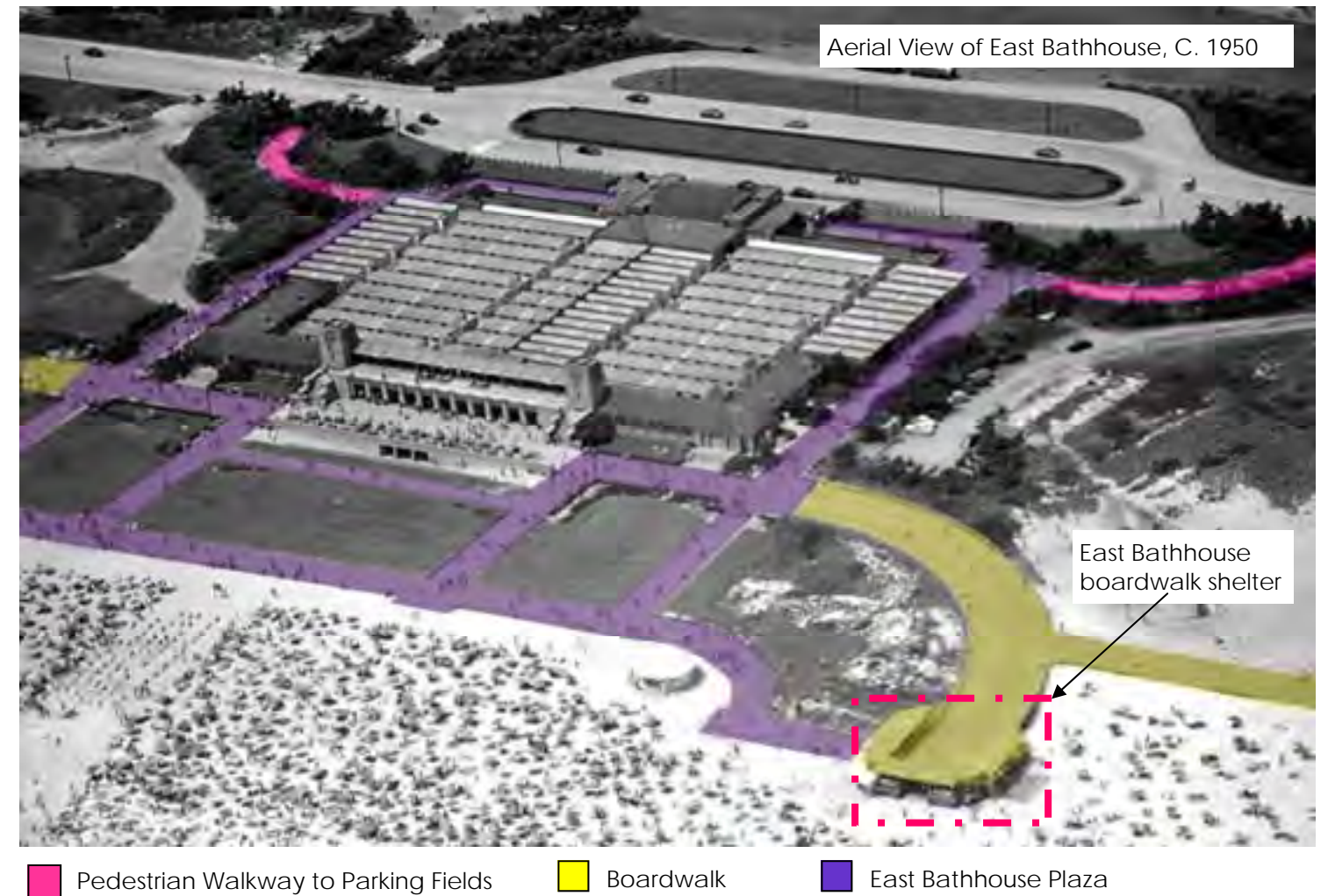

East Bathhouse Plaza, 1949. Note shaped hedges and wide pathways.



EBH Plaza, 1950 Note wide swaths of lawn between EBH and the beach.



East Bathhouse Boardwalk Shelter, 1940's

EAST BATHHOUSE—LANDSCAPE

SUMMARY OF EXISTING CONDITIONS

The East Bathhouse landscape is in fair condition. The overall layout of the historic landscape is still intact but the many of the plantings and lawn features have been lost or have become overgrown.

Storm Damage:

Super Storm Sandy washed away soil, grasses and deposited sand on the south plaza between the beach and the EBH. This has eroded the clean lines of the plaza created by the contrast between the pathways and lawn and sand. The cooling effect of the last expanse of lawn has also been lost.

Planting Loss:

- The clean, geometric lines of the carefully trimmed hedges and shrubs around the building have been lost. Trees and shrubs are now set in mulched planting beds and shaped into rounded and irregular forms. Many of the shrubs on the north façade have also become overgrown and are obscuring too much of the building. The overgrown planting that are too close to the building also trap moisture on the masonry accelerating deterioration.
- The slightly wilder sections of the landscape were also effected by time and storm damage. Many of the larger shrubs have survived but the varieties of beach grass along the perimeter are threatened. The beach grass helps keep the sand and soil in place preventing erosion and blowing sand.



EBH, South lawn 2013
Loss of lawn.



EBH, Northeast, 2013
Loss of parterre planting plan.



EBH, Southeast corner of plaza, 2013
Erosion of dunes due to loss of beach grasses.

← Eroded/blown sand.



EBH, Southeast corner of plaza, 2013
Thriving shrubby with weak growth of grasses.

EAST BATHHOUSE: USE, SIGNIFICANCE & PRESERVATION

SPACE & USE

Recommendation:

The East Bathhouse is currently greatly underutilized. Much of the building is not in use and closed to the public.

Historic (1929-66)

| Description | Sq. Foot (Aprox.) |
|---------------------------------|-------------------|
| North Building Loggia: | 2,700 sq. ft. |
| North Building Lobby: | 9,500 sq. ft. |
| Central Block (changing areas): | 80,000 sq. ft. |
| Central Promenade: | 5000 sq. ft. |
| East & West Promenades: | 7500 sq. ft. |
| Restrooms: | 5,000 sq. ft. |
| Terrace Patio: | 8,500 sq. ft. |
| Sun Deck (2nd floor): | 4,000 sq. ft. |

Current (2013)

| Description | Sq. Foot (Aprox.) | Used (?) |
|-----------------------------|-------------------|----------|
| North Building Loggia: | 2,700 sq. ft. | No |
| North Building Lobby: | 9,500 sq. ft. | No |
| Central Block (Pool): | 70,000 sq. ft. | No |
| Changing Rooms (new blocks) | 65000 sq. ft. | No |
| Restrooms: | 10,000 sq. ft. | Yes |
| South Building Concession: | 5000 sq. ft. | No |
| South Building Admin: | 7500 sq. ft. | Yes |
| Terrace Patio: | 8,500 sq. ft. | Yes |
| Sun Deck (2nd floor): | 4,000 sq. ft. | Yes |

SIGNIFICANCE

The East Bathhouse is significant:

1. As an important component of the formal Beaux Arts plan of Jones Beach State Park.
2. For its architectural design. The building reflected careful thought regarding use, layout, materials and ornamental design. These elements are skillfully used together to create a structure that works individually and as part of the overall park design.

Significant Elements include:

1. **Materials.** The use of specific materials was consistent throughout Jones Beach and helped maintain a sense of unity through the large park. Important materials uses at the EBH include Barbizon Brick, buff colored sandstone, cast stone and copper trim element.
2. **Design Elements.** Important design elements include:
 - Three part building structure (North building, Courtyard and South building).
 - Low horizontal massing of the building anchored by the square towers.
 - Symmetry of facades & spaces
 - Art Deco design elements
 - High level of ornamentation on primary elevations.
 - Original brick screen walls.
 - Screening of courtyard uses/structures.
 - Promenade in South Building
 - Sun Terrace with fixed frame canvas awning
 - Landscape design, especially south plaza
 - Incorporation of EBH landscape into JB
3. **Function & Design.** The relationship between design and function is significant. The level of ornament on the building reflects its use. The highly ornamented section along the ocean reflects a public use while the relatively unadorned brick screen wall represents a more utilitarian purpose.
4. **Period of Significance: 1929**

TREATMENT

Recommendations: Rehabilitation

Retention and preservation of Historic Materials

1. The impact of alterations, repairs and even code upgrades should be weighed in terms of their effect on historic fabric. Code requirements specifically the ability to meet health and safety, energy codes and ADA requirements should be addressed without damaging historic spaces, features or finishes.

Repair of Historic Materials and Features

1. Many important features are threatened by deterioration including the sandstone, Barbizon brick & copper trim features. When necessary deteriorated fabric should be replaced in kind but the primary goal should be the preservation of historic fabric.

Replacement of Missing Historic Features

1. The EBH has lost many of its significant features. Where possible historic documentation should be used to replicate losses due to deterioration or alteration. Missing or altered elements include:
 - Loggia & North Building Lobby
 - Interior Promenade in the South Building
 - Exterior of East & West Promenades
 - Sun Terrace & fixed frame awnings (45°)
 - Art deco design elements on north and south buildings. (Lighting elements, masonry trim, finials, clocks etc.)

Removal of Inappropriate modern additions/features

1. Removal of aluminum & fiberglass awning on south facade including wind screens.
2. Door & windows should be replaced as their lifespan comes to an end with windows and doors that replicate the appearance of the original windows and doors.

ZONE 2: THE BATHHOUSES
WEST BATHHOUSE



**EAST BATHHOUSE
CHRONOLOGY OF DEVELOPMENT & USE**

- The West Bathhouse was designed by Herbert Magoon, AIA in 1929-1931.
- The drawings were approved & signed by Architect/Engineer W. Earle Andrews.
- The corner stone of the West Bathhouse was laid by Franklin Delano Roosevelt, then New York State governor, in 1930.
- The WBH is composed of a north entrance building on Ocean Parkway and a monumental south building on the beach. A large central courtyard with pools and viewing decks flanked by changing areas was set between the north and south buildings. A brick screen wall connected the two buildings and enclosed the courtyard. The south building featured a formal Art Deco terrace level that included the Marine Dining Room, lobbies, private dining rooms and outdoor terraces. The first floor featured a café, first aid station, beach shop and restrooms. The building is 150,000 sq ft (approx).
- In 1953-55, the building under went a major alteration. The original floor plan of the south building was drastically altered as was the terrace level of the building. Passages were sealed, windows were bricked in and spaces were reoriented.
- Additional alterations to the building's design and fabric were also undertaken 1970's & 80's in response to deterioration and changes in use.
- In 2009, a major masonry restoration project was undertaken.



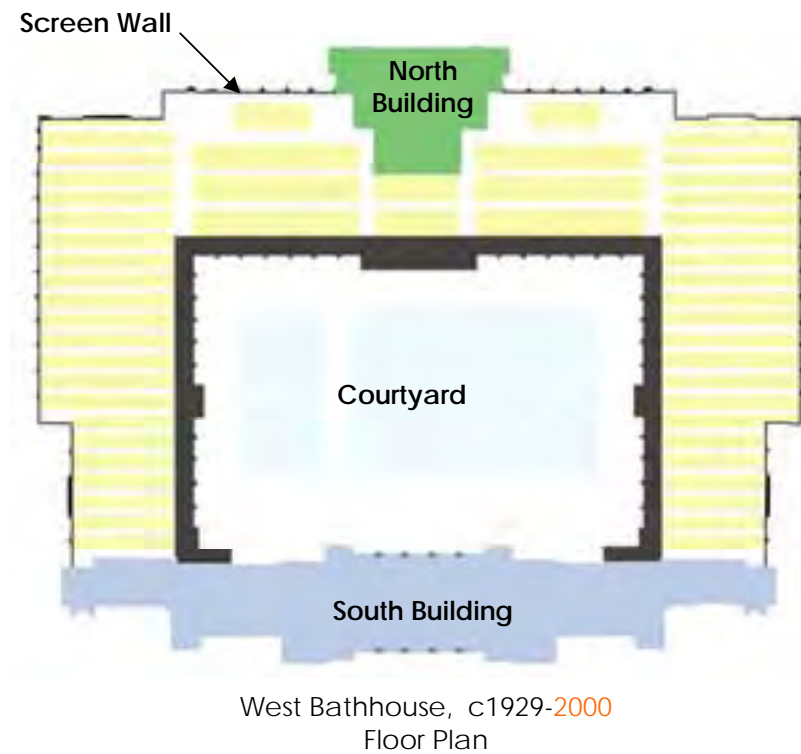

WEST BATHHOUSE (1930-1953) CHRONOLOGY OF DEVELOPMENT & USE

- The WBH was designed as a massive multipurpose structure similar to the EBH but larger and grander. The building included three primary sections; the north entrance building, a central courtyard and the south building. The central courtyard was enclosed with a brick screen wall. This wall connected the north and south buildings and screened the courtyard from view.
- The **North Building** was the primary public entrance to the WBH. This building was located on Ocean Parkway and had space allocated for ticket counters, rentals, valuables storage and information. The space also provided the primary entrance to the changing rooms.
- The **Courtyard** an inner courtyard is located at the center of building and featured a large open courtyard with two pools flanked. An outer courtyard surrounds this area and housed the changing areas. The changing areas had hundreds of changing rooms, showers and lockers. The space was open (no roof) and the individual changing rooms were housed in rows of cabana style buildings. The rows of open buildings ran perpendicular to the brick screen walls that enclosed the courtyard. The roofs of the cabana buildings was just below the capstones of the screen wall, shielding the structures from view.
- The **South Building** was far larger and grander than the rest of the structure. The sprawling masonry building features symmetrical flanking pavilions, six story towers, crenelated terraces, balconies and fabric awnings. On the interior the building featured a 'formal' terrace level with high style Art Deco finishes and a more utilitarian ground floor. The terrace level featured the Marine Dining, lobbies, private dining rooms and terrace dining & dancing. The ground floor featured café style dining with restrooms located in the far wings.





WEST BATHHOUSE (1930)

NORTH BUILDING

CHRONOLOGY OF DEVELOPMENT & USE

- The North building of the WBH features a low horizontal profile along Ocean Parkway. A deep loggia runs along the front of the building.
- The central three bays of the building are set between two square towers of Ohio sandstone. The bays are defined by two smooth concrete piers and two sandstone piers that extend through the roof line and are capped with Art Deco lanterns. Paired flag poles extend up from a recessed channel in the face of the towers. The flag poles originally features bronze strap work and decorative bronze finials.
- An additional bays is set on the outside of each tower extending the length of the loggia. The roof is supported by sandstone piers and a wide wood fascia runs the length of the façade.
- The central block of the building originally featured a wood shingled hipped roof. The towers and loggia had flat roofs.
- The building walls under the loggia were primarily Barbizon brick with cast stone, wood or sandstone trim. This includes the interior face of the sandstone towers. The ceiling was sanded plaster with exposed wood beams.
- The interior/lobby of the north building was separated from the loggia by a open wood screen and a row of ticket booths. Copper screening was used to keep birds and insects out of the lobby. The finish of the ticket booths and wood screening is unknown at this time.
- The ticket booths featured wood posts with decorative finials and Barbizon brick set in decorative patterns.
- Each bay under the loggia was originally lit with custom designed Art Deco chandeliers. Decorative wood grilles were used to vent the ceiling of the towers.
- The brick screen wall that encloses the courtyard is set back from the main façade and extends 180' to the east and west. The one-story wall is constructed on Barbizon brick and features battered brick piers and sandstone arches. Decorative drinking fountains were also built into the wall on each façade. Opening in the wall featured medieval style wood gates with decorative iron strap work.



North Building, North Elevation under construction c.1930.



North Building, East Elevation of Loggia c.1970



North Building, Loggia—Wood Screen Wall 2009.



North Building, Loggia c.1970. Note Art Deco Chandeliers

**WEST BATHHOUSE (1930)
NORTH BUILDING—INTERIOR**

CHRONOLOGY OF DEVELOPMENT & USE

- The north lobby provided access to the courtyard and changing areas as well as valuable storage and rentals (bathing suits to lockers).
- A wood screen with ticket booths divides the space between the loggia and the lobby. The wood screen was varnished and featured an alternating pattern of decorative balusters.
- The interior of the lobby featured durable materials and finishes because the space was partly open to the elements. Materials included slate flooring, sanded concrete ceilings and Barbizon brick walls.
- The Barbizon brick on the walls was set in a variety of patterns adding a whimsical touch to the space. Header, stretcher, soldier and rowlock coursed were used.
- Richly varnished wood ceiling beams and service counters adorned the lobby adding a luxurious feel to the space.
- The main source of light is a three bay skylight that runs the length of the lobby. The wood surround was originally varnished to match the rest of the wood trim in the space. Shallow Art Deco ceiling fixtures augmented the natural light.

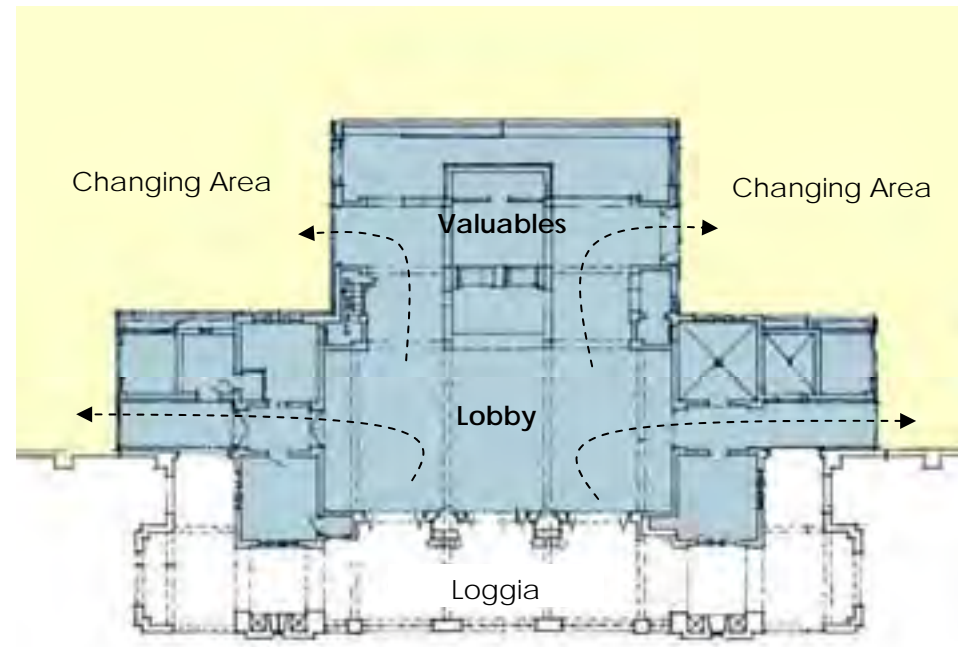

Interior of Lobby—Circulation Plan

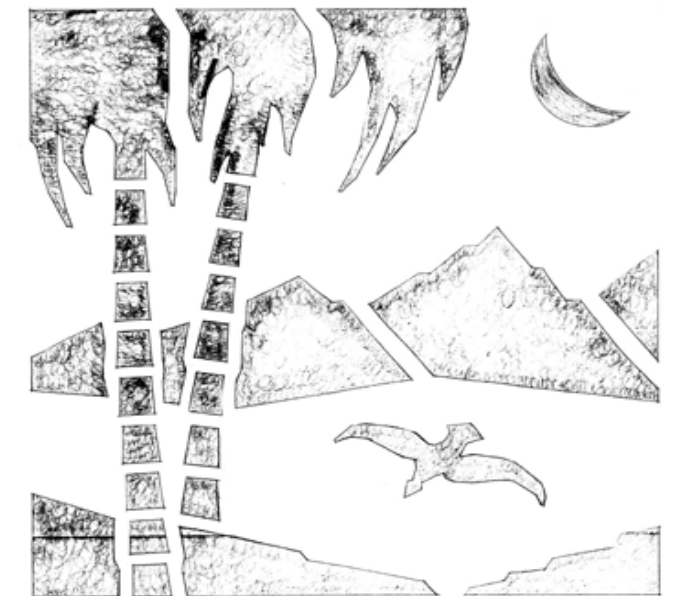
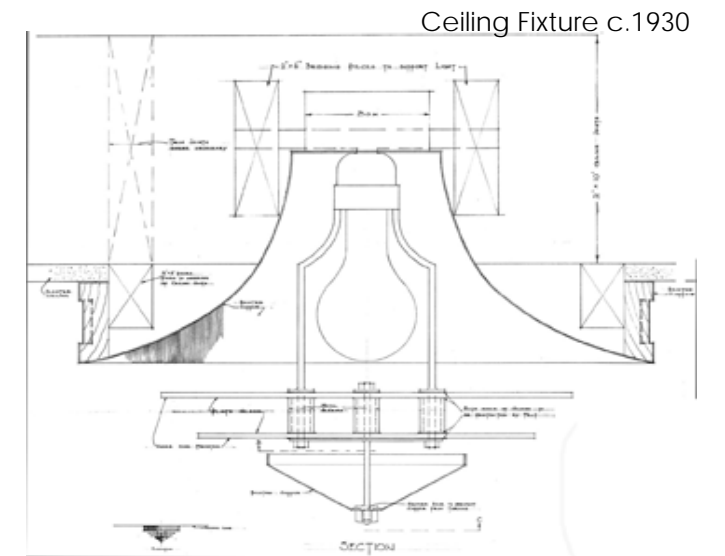

Ceiling Grille c.1930



Interior of Lobby—Service Counter 2009



Interior of Lobby c.1930's



Decorative Brickwork 2009

West Bathhouse
South Façade c. 1940's



WEST BATHHOUSE (1930)

SOUTH BUILDING—SOUTH FAÇADE

CHRONOLOGY OF DEVELOPMENT & USE

- Stylistically the WBH is a primarily a Beaux Art structure with applied Art Deco motifs. Symmetry and hierarchy of space are the two main components on the building's design. Repeated ornamental motifs and strong sculptural elements help unify the building and connect it to the larger Bathhouse complex.
- The South building features two primary façades, the north elevation on the pool and courtyard and the south elevation facing the beach. Entrances are also located on the terrace level of the building on the east and west façades. Symmetrical sets of wide stairs lead up to the terrace level on each side of the south façade.
- The central section of the north and south façades of the south building are nearly mirror images of each other as are the east and west façades. Important differences, however, define the use and importance of the space. A clear hierarchy of spaces is established at the WBH by the use of materials and ornamentation. Ohio sandstone and an abundance of Art Deco ornamentation is used on the primary façades while Barbizon brick and limited detail is used on secondary façades.
- The south façade is clearly the most significant elevation of the building, possibly at Jones Beach. The sprawling masonry building features symmetrical flanking pavilions, balconies, towers and low one-story wings. The masonry façade, towers, crenellated terraces, and fabric awnings worked together to create a whimsical castle like structure.
- The horizontal nature of the building is created by the bands of cast stone, rows of window and doors and the horizontal lines of the low-pitched roofs and fabric awnings.
- The projecting towers that flank the central section of the building help anchor the façade as do the shorter, square pavilions. Each tower features a two-story fountain centered on the façade. The circular opening at the top of the fountain is connected to a recessed apse and pool at the base by a limestone lined channel. The channel was originally back lit and the circular opening was a window in the Marine Dining Room.

West Bathhouse c. 1930
Detail—Tower of south façade
under construction.

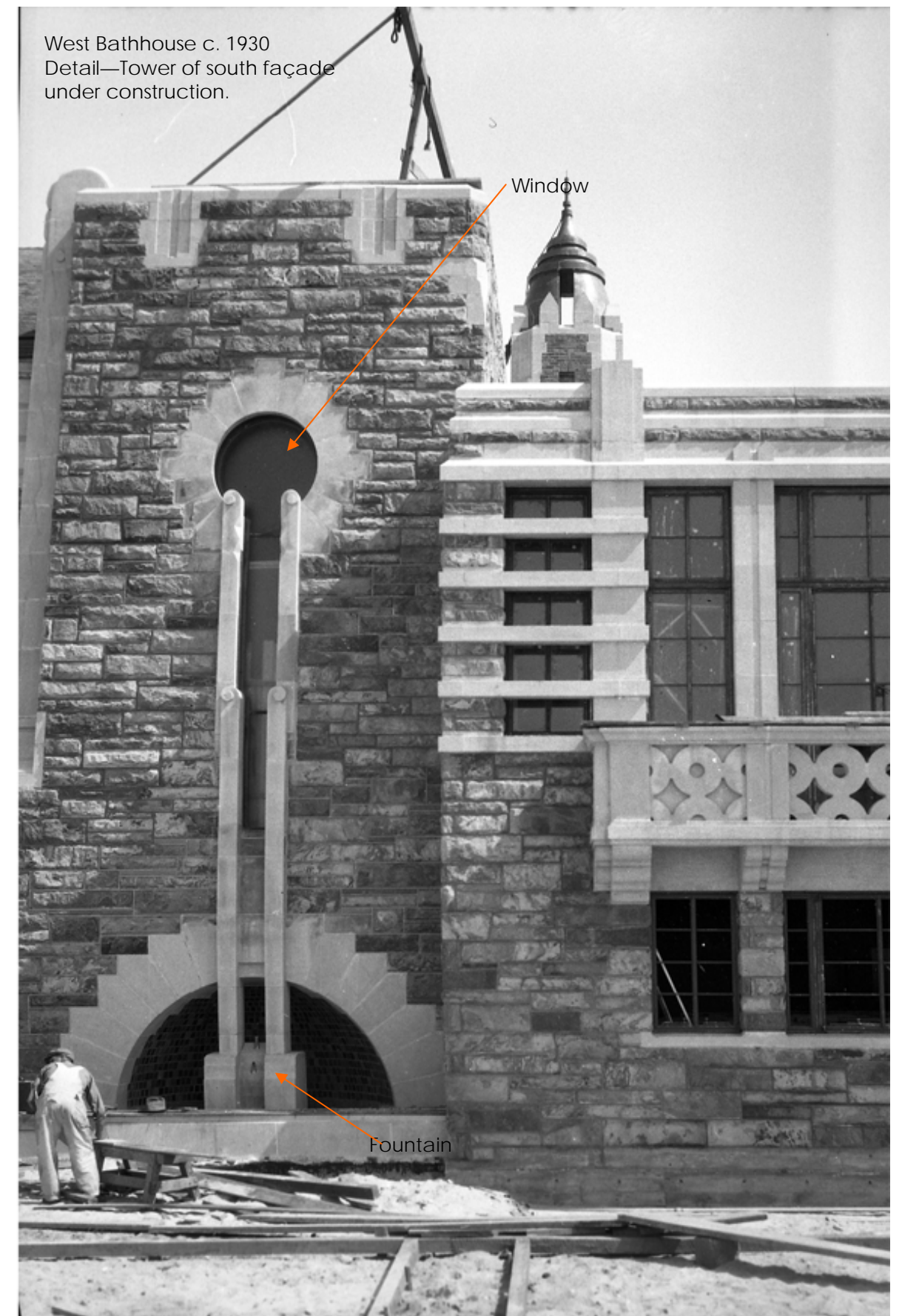

WEST BATHHOUSE (1930)
SOUTH BUILDING—SOUTH FAÇADE

CHRONOLOGY OF DEVELOPMENT & USE
(continued)

- The central three bays of the south façade originally featured large windows on the terrace level and door opening on the ground floor. The door opening featured a narrow transom of small square lites with a central set of French doors below. Each pair of French doors was flanked by a matching side light.
- The two outside bays featured windows on the terrace levels and battered sandstone walls on the first floor. A single cast stone grille was set in the center of the opening.
- Wide bands of cast stone ran across the façade over the windows and doors. Repeating patterns of geometric shapes are molded into the cast stone. Narrow piers of sandstone with cast stone trim and capstones penetrate the roofline and divide the bays.
- The towers that flank the central block of the façade feature a cast stone decorative elements that extends from the top of the parapet down one side of the tower. The Art Deco ornament resembles a stylized wave cascading down the building.
- Identical pavilion are located on the outside of the towers. Each two-story pavilion features a large cast stone balcony. The pavilions are defined by wide bands of cast stone along the cornice and at the corners. Narrow rectangular windows are set between the bands of cast stone.
- A one-story open terrace extends out from each of the pavilions. The far end of the terrace was anchored by the tall, narrow side walls of the band shells. A crenellated sandstone parapet connects the two structures. The connection between the band shell and the pavilion was originally reinforced by canvas awnings. The canvas awning were supported by wood posts with carved finial caps.
- At the far end of the building is a one-story brick wing with low pitched hipped roof. The treatment of the façade is very similar to the brick screen wall that encloses the courtyard; battered brick piers and cast stone cap stones. This section of the building was clearly secondary and houses restrooms.

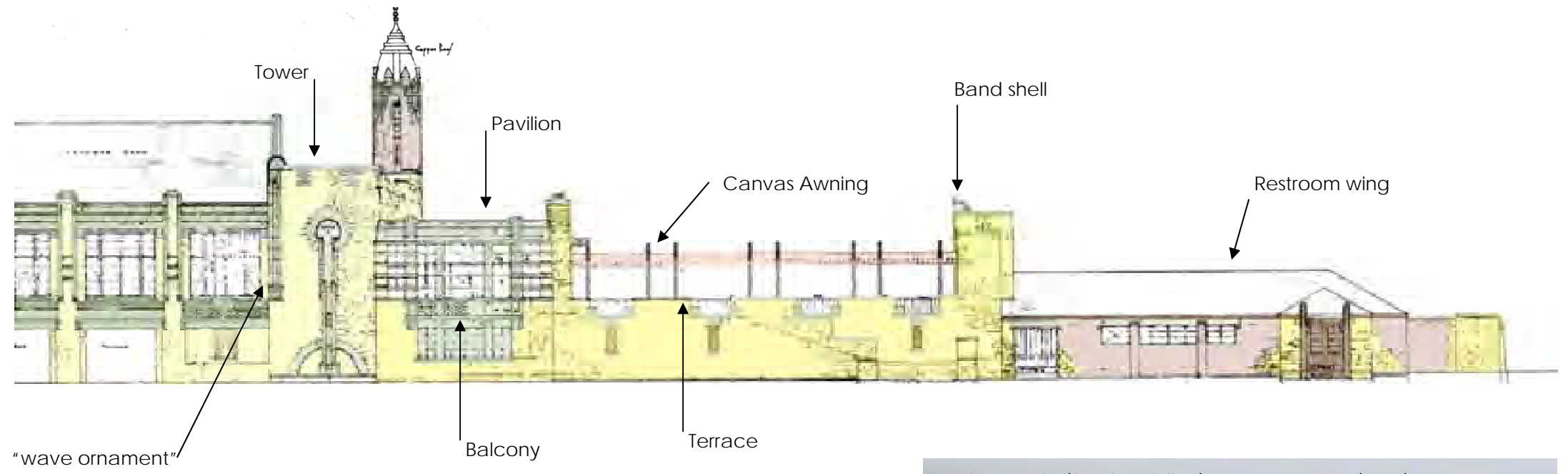

South Façade (South Building) c.1930's.

WEST BATHHOUSE (1930)
SOUTH BUILDING—EAST & WEST FACADES

CHRONOLOGY OF DEVELOPMENT & USE

- The east and west elevations are mirror images of each other featuring identical ornamentation, fenestration and overall design. Each elevation has a grand Art Deco entrance to the forma terrace level of the South Building as well as the primary elevations of the adjacent band shells. The two facades are connected by the terrace which was designed for outdoor dining.
- A combination of Ohio Sandstone and Barbizon brick is used on each façade. The sandstone wraps around from the south façade, continuing across the main entrance below the awning. Barbizon brick wraps around from the north elevation meeting the sandstone at the entrance and extending across the parapet over the awning.
- Cast Stone trim is used across the façade calling out features on the entrance, around windows, on the parapet, and in the wide horizontal bands that wrap around from the south elevation. Art Deco, cast stone lanterns extend up through the parapet at the entrances. Smaller, abstract shell ornaments are set between the lanterns over the entrances. The main entrances are marked by a projecting cast stone canopy with scalloped edges.
- The terrace level entrance is deeply recessed in the square opening under the canopy. Bronze French doors with sidelights and a wide transom are set in the opening.
- Band shells are set at the far end of the terrace. The band shells are constructed primarily of Barbizon brick with sandstone and cast stone ornament. The brick was set in decorative patterns around and within the arch of the band shell. Select Roman bricks were used to reinforce and call out the brick patterns. A wrought iron chandelier originally hung in the center of the opening.
- The terrace featured a crenellated masonry parapet, sandstone on the south elevation and brick on the north. Gun slit windows are set below the cutout section of the crenellations. Metal safety railings were set in the cutouts.
- Fixed frame canvas awnings (45°) were set along the perimeter of the terrace. The awnings were supported by wood posts with carved (polychrome) finials.



West Bathhouse, c1930's
 West Terrace



West Bathhouse, c1940's
 East Elevation



West Bathhouse, c1940's
 South/west Elevation



West Bathhouse, c1940's
 Stair to East Terrace

WEST BATHHOUSE (1930)
SOUTH BUILDING—TERRACE INTERIOR
CHRONOLOGY OF DEVELOPMENT & USE

- The terrace level of the WBH was the most formal and high style spaces at Jones Beach. The interior was finished with high end materials in an Art Deco style.
- The original main gallery ran the length of the seven central bays of the building. The long rectangular room with high ceilings and a false skylight originally housed the Marine Dining Room. The space was dominated by five large windows on the south façade that provided views of Jones Beach and the Atlantic ocean.
- The Marine Dining Room featured carved oak ceiling beams, skylight surround and wood coffers around the perimeter of the room. The ceiling was sanded concrete.
- The wall were also sanded concrete with decorative wall panels and wainscoting of carved marble. Art Deco style patterns were carved into the marble panels.
- The Fountain windows at the east and west ends of the gallery were framed with marble. Marble reception desks were located in front of the windows.
- Shallow Art deco wall sconces lined the walls.
- The far east and west ends of the terrace housed the formal entrance lobbies and private dining rooms and restrooms/coat check areas.
- The lobbies featured custom Art Deco chandeliers, oak paneling, whimsical columns, custom telephone booths with leaded glass and decorative ceilings.
- The private dining rooms also featured oak paneling, decorative ceilings and abundant windows or balconies.
- The space to the north housed service spaces including the kitchen and storage. The kitchen originally featured large windows overlooking the courtyard.



WBH, West Lobby c1930's

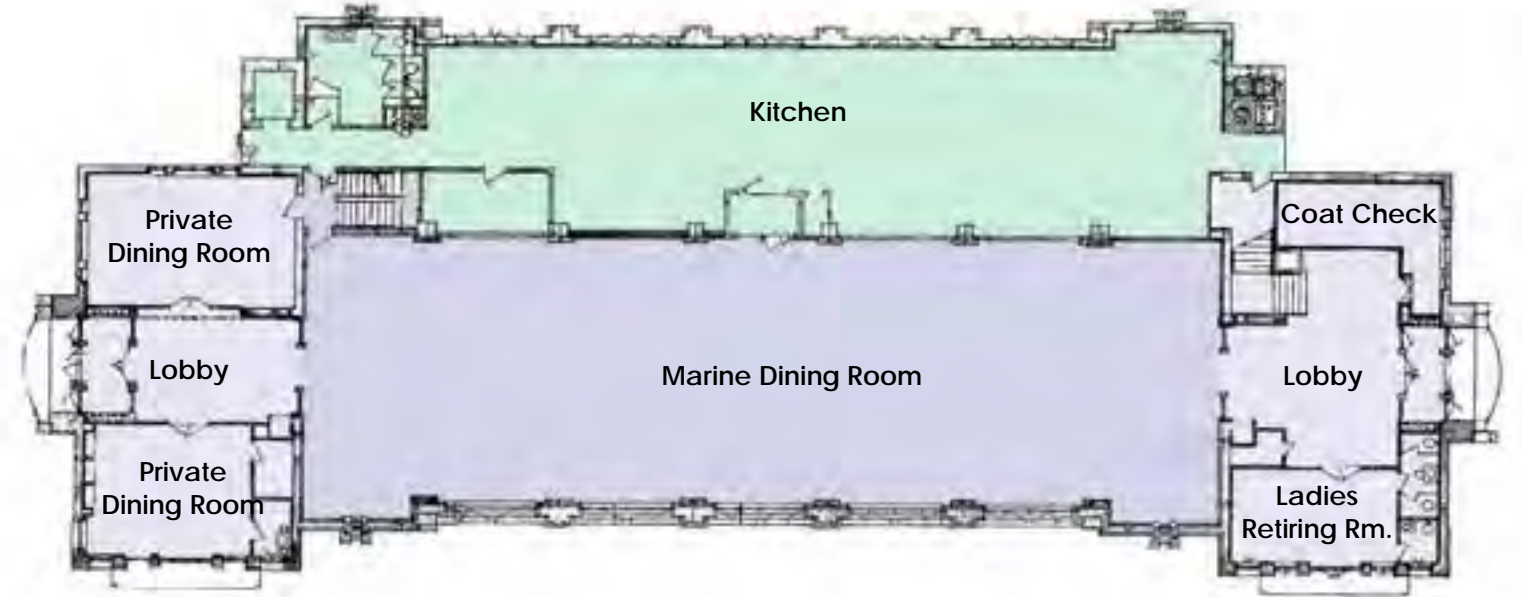

WBH, Terrace Level floor plan 1930



WBH, Marine Dining Room, c1930's



WBH, Marine Dining Room c1930's

WBH SOUTH BUILDING (1930)

DESCRIPTION

EXTERIOR - North Facade

- The north façade overlooks the courtyard. The façade is a mirror image of the south elevation; a five bay section flanked by two-story square towers, tall six-story towers, and open terraces. The façade also originally featured a third story viewing deck over the central five bays.
- Unlike the south façade, the north façade is constructed primarily of Barbizon brick with cast stone trim elements. The five central bays are divided by two-story brick piers that project through the roof line.

EXTERIOR - Courtyard

- The Courtyard is located at the center of the West Bathhouse complex and includes the pool deck, two pools and the perimeter wall that encloses the area on three sides. The fourth side of the courtyard is enclosed by the north elevation. In total, almost sixty-four thousand square feet are enclosed at the center of the Bathhouse.
- The courtyard of the WBH is connected to the rest of the structure and JB by the use of common materials and architectural motifs.
- The perimeter wall is very similar in design and materials to the brick screen wall that encloses the exterior of the WBH.
- Barbizon brick is the primary material on the courtyard walls with cast stone trim. The cast stone trim includes a cast stone railing with stylized geometric shapes. A stylized version of the life preservers motif was executed in the cast stone railings. Real life preservers were centered on each bay of the courtyard railing.
- Flagstone was the original decking material used on the courtyard. Flagstone was also used on the interior flooring of the north lobby, the loggia, and the south terrace.
- The primary access points in the courtyard are marked by Ohio sandstone and secondary access points are called out by cast stone trim. The doors are wood batten doors with wrought iron straps and hardware. Many of the doors feature decorative patterns including herringbone, diagonal and vertical batten.
- Two types of stairs are used on the courtyard: large open stairs on the south elevation at the east and west corners, and a double set of stairs centered on the north elevation. Both types of stairs are primarily constructed on Barbizon brick with cast stone or sandstone trim. The stair treads were flagstone.
- The courtyard is dominated by two pools: a shallow wading pool and a large swimming pool. The current pools replaced the original two pool in the 1950's. The original heated, saltwater pool was replaced with fresh water.
- The main (original) pool originally featured a large diving platform with multiple diving boards. A oversized flag pole that resembled a ships mast was originally set into the diving platform.



West Bathhouse, Courtyard 1930's

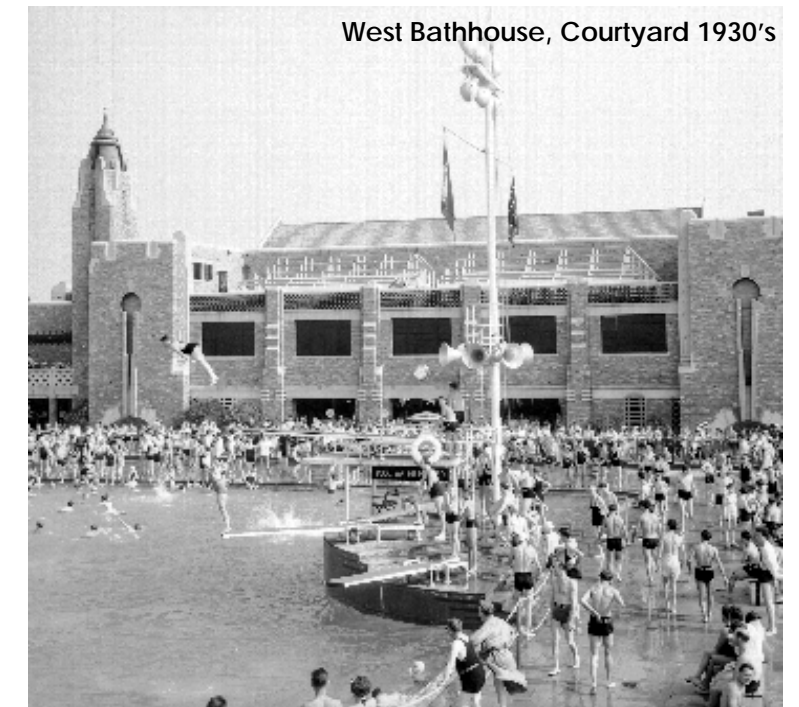

West Bathhouse, Courtyard 1930's



West Bathhouse, Courtyard 1930's

WBH, Ground Floor Plan 1930

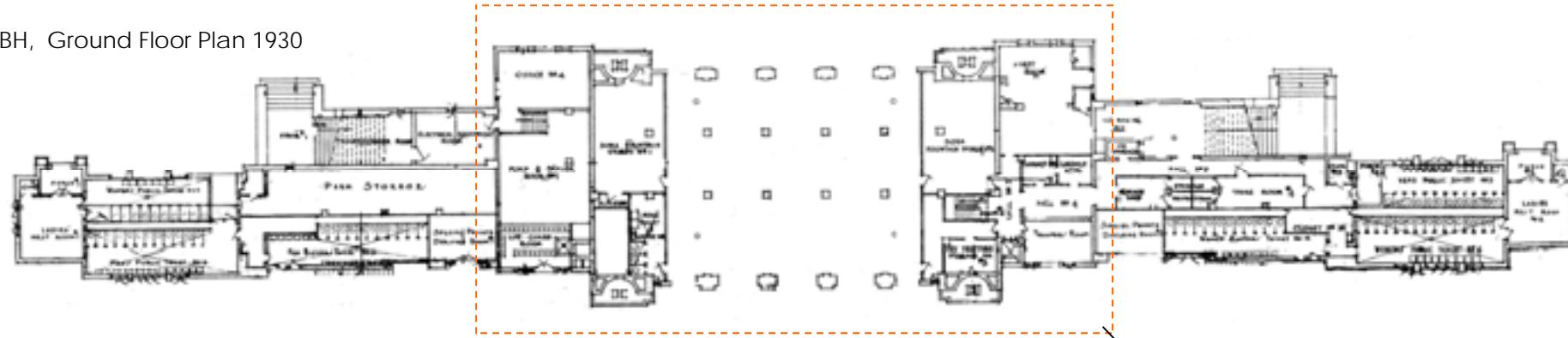

WEST BATHHOUSE (1930)
SOUTH BUILDING GROUND FLOOR
CHRONOLOGY OF DEVELOPMENT & USE

- The ground floor of the WBH was more functional and utilitarian compared to the terrace level. Restrooms, service areas, storage areas and a less formal food service area were located on this level.
- The ground floor level food service area featured a soda fountain style restaurant to serve beach and pool patrons. The restaurant was very different from the terrace level Marine Dining Room.
- The interior of the Soda Fountain was streamlined and functional. Structural components were left exposed including arches, beams and columns. Ornamentation was very limited and finishes included painted concrete and glazed ceramic tile.
- Long service counters ran along the east and west wall of the open central section of the building. The service counters were perpendicular to the open passages along the courtyard and the French doors to the south patio. The configuration allowed counter service to both



Detail of North Elevation (1930's). Note the open passages in the central bays of the building. The concession counters lined the outside walls of the large open interior space. The open passages allowed a clear view of the ocean from the pool courtyard.

Detail of Ground Floor Plan (1930)

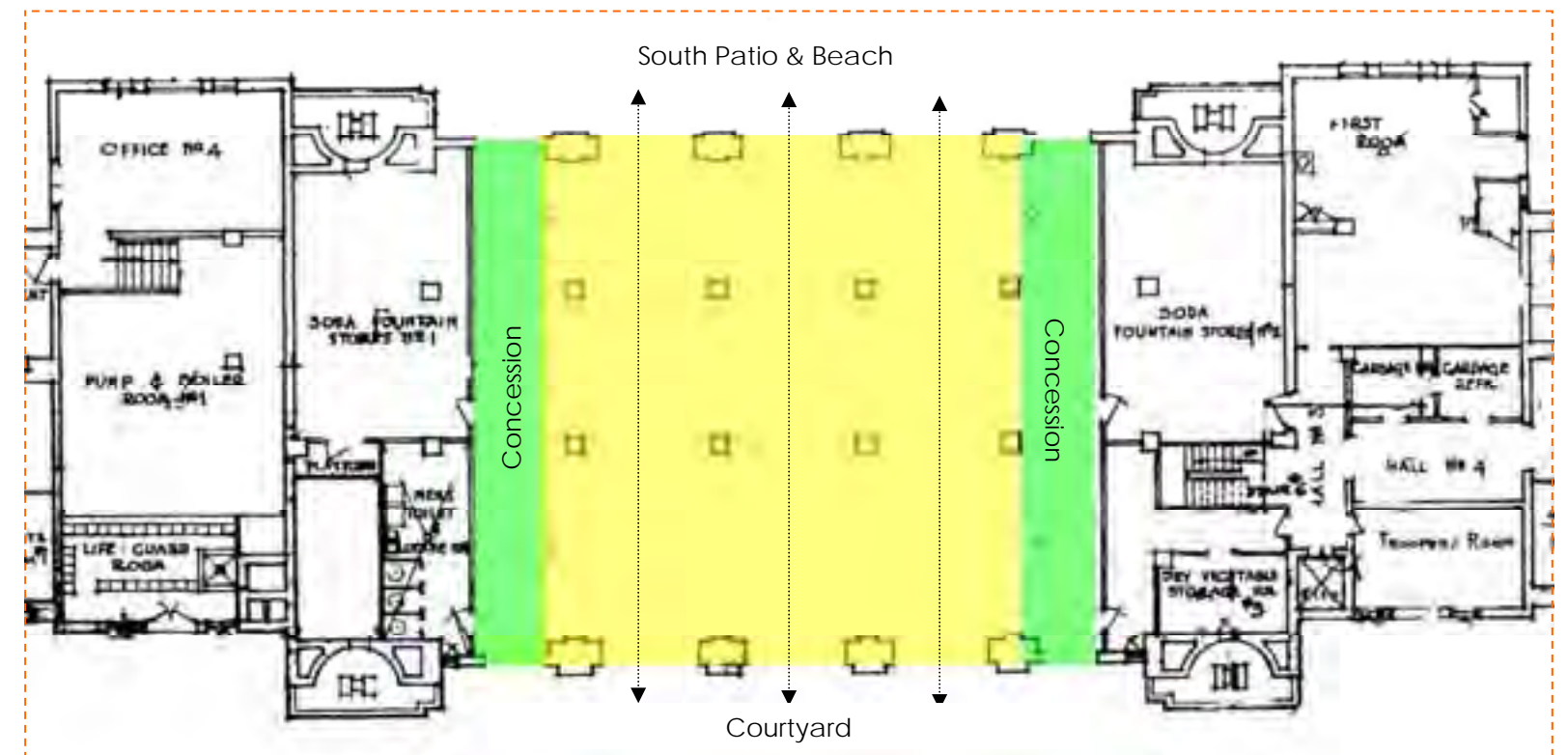

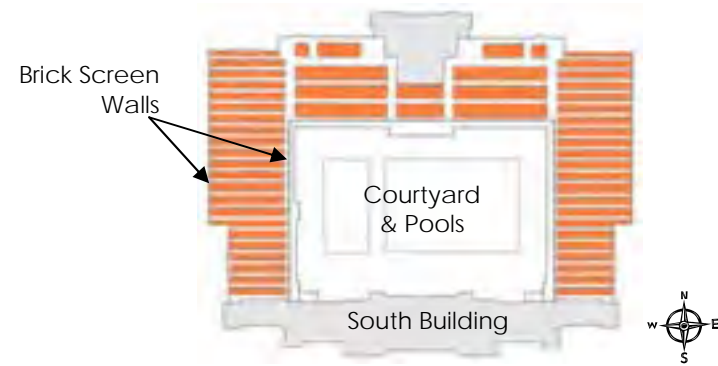

WEST BATHHOUSE (1930)
COURTYARD CHANGING AREAS

CHRONOLOGY OF DEVELOPMENT & USE

The north and south building of the WBH are connected on the east and west by a brick screen wall. The buildings and screen wall enclose a huge area. A second brick screen wall with a terrace encloses a second smaller courtyard at the center of the space. This courtyard houses the pools and pool deck. The area between the two screen wall originally housed the changing areas.

- The changing areas were accessed either through the north building lobby, from the pool deck or from spiral staircases from the sundeck of the courtyard. The spiral staircases were streamlined modern metal staircases.
- The changing rooms and lockers were housed in long, narrow cabana style buildings that were set in rows perpendicular to the screen walls. Each cabana building housed dozens of changing rooms.
- The changing area also housed restrooms, showers and lockers. The changing area also featured unique items including bathing suit ringers/dryers (for wool bathing suits), baby bottle warmers and feet washers.
- As a secondary and high use area, the changing rooms were constructed of less opulent and more durable materials. The floors was concrete pitched for drainage and the buildings were concrete block or wood frame. The area was very practical and functional with limited ornamentation.



Changing Rooms (1939)



Brick screen wall 2009



Changing Area with bathing suit ringers (1939)



Aerial View of West Bathhouse (1930's)



Changing Rooms with spiral staircase (1930's)

West Bathhouse, 2009
South Elevation



West Bathhouse, 1930's
South Elevation



West Bathhouse, 2009
South Elevation



West Bathhouse, 2009
Band shell



WEST BATHHOUSE—SOUTH BUILDING SOUTH ELEVATION

CHRONOLOGY OF DEVELOPMENT & USE (1953-PRESENT)

- Unfortunately, the south building has undergone multiple alterations. Alterations are primarily the result of deterioration, inappropriate repairs & changes in function.
- Almost all of the windows on the south building, including the large windows on the terrace level were replaced in the 1950's and again in the 1980's. The configuration of the new windows does not match the historic design and significantly alters the appearance of the building. Reflective glass is also used in some location.
- The openings on the ground floor have also been altered. The original French doors with transoms have been replaced with large single pane metal doors. New openings have also been created in the formerly battered stone bays.
- The large fountains are also no longer functioning and the pools have been removed.
- The fixed frame canvas awnings and wood post have also been removed. This greatly alters the appearance of the building and reduces the connection between the band shell and the main block of the building.
- Historic materials have also been replaced with inappropriate materials. The original quarry tile on the terraces has been replaced with poured concrete and some of the brick parapet walls were replaced with a poor substitute for the historic Barbizon brick.

**WEST BATHHOUSE—SOUTH BUILDING
TERRACE LEVEL INTERIOR**

**CHRONOLOGY OF DEVELOPMENT & USE
(1953-PRESENT)**

- The Terrace level of the WBH underwent a major alteration in 1955. Cultural and demographic changes lead to the replacement of formal dining with more casual cafeteria dining.
- The overall configuration of the space remained primarily the same but major alterations were undertaken. The skylight and ceiling beams were enclosed, the marble was removed, the fountain windows were sealed and the lobbies were closed off.
- The walls were painted pink, pink striped wallpaper was added and new lighting via 'modern' chandeliers was provided. A cafeteria counter was also installed along the north wall.
- The private dining rooms were converted in private offices: one became Robert Moses' office for a time.
- The windows were replaced in the 1950's and in the 1980's.
- The space was remodeled again and again. Eventually, the space was divided into a large concession area and a conference room.
- The lobbies were eventually disused or remodeled. Much of the original Art Deco ornamentation was covered up or lost.
- A Friendly's concession is now located in the west half of the space. A standard Friendly's commercial service counter dominates the space.
- The conference room is created by a partition wall that divided the long gallery.

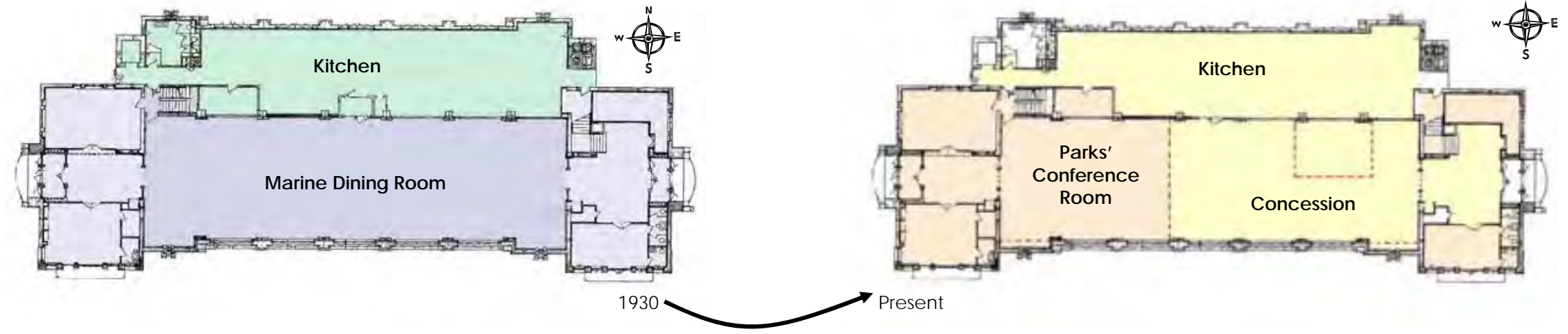

West Bathhouse, Terrace level cafeteria 1955



West Bathhouse, Terrace level conference room 2009



West Bathhouse, Terrace level concession 2009



West Bathhouse, North elevation 2009



West Bathhouse, North elevation 1950's



West Bathhouse, North elevation 2009

**WEST BATHHOUSE—SOUTH BUILDING, NORTH FACADE & INNER COURTYARD
CHRONOLOGY OF DEVELOPMENT & USE (1953-PRESENT)**

The north elevation of the building has been dramatically altered. The exterior alterations are primarily the result of alterations to the interior spaces. Changes include:

- The second floor windows have been sealed with brick.
- Four of the five ground floor passages have also been enclosed.
- A takeout window has been added in one of the ground floor passages.
- The terrace (3rd floor) parapet has been replaced and the viewing terrace closed to the public.
- The tower fountains are no longer functioning
- New windows and doors have been installed that do not match the historic style or configuration
- The pools were reconfigured in 1950's and have been relined many times.
- The bluestone pavers on the pool deck were replaced with marble and are in need of replacement again.
- The awnings on the terraces have been removed.
- The terrace level sun deck has been closed off as have the stairs that lead up to the terrace level.
- New metal railings have been installed on top of the brick parapets.



West Bathhouse, Courtyard 1950's

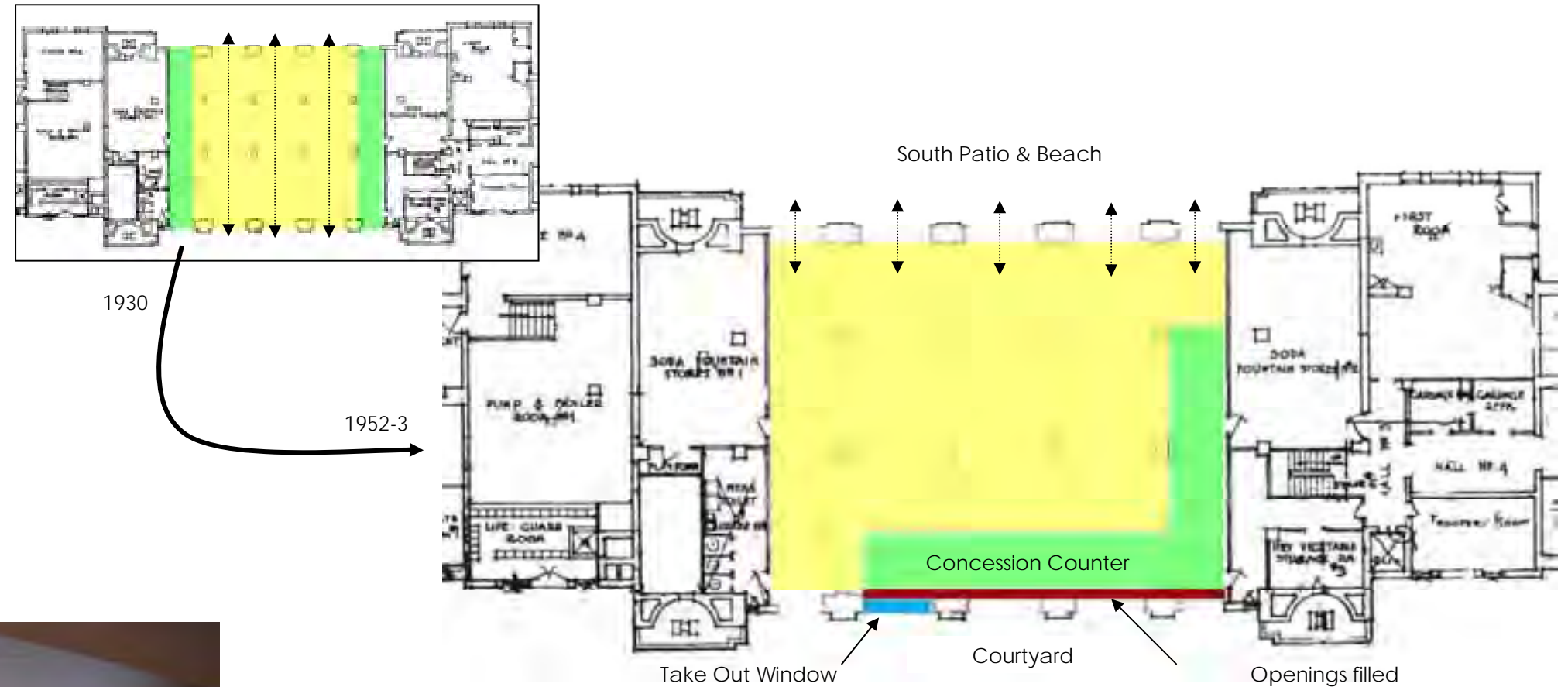

WEST BATHHOUSE—SOUTH BUILDING GROUND FLOOR CHRONOLOGY OF DEVELOPMENT & USE (1953-PRESENT)

- In 1953 the ground floor of the south building was significantly altered. The open passageway through the building was closed. The entire layout of the central space was completely reconfigured.
- The concession counter was reoriented; set along the north and west wall. To facilitate this configuration, four of the open passages on the north elevation were bricked in. Three windows with aluminum grilles were added to each bay.
- The two battered stone bays on the south façade were also eliminated. A new entrance was located in one bay and second became a service entrance.
- At a later date access to the concession area was restricted to the south entrance. A take out window was installed to provide service to the courtyard patrons.
- Over time drop ceiling, new flooring and partitions were added to the space. The doors and windows were also replaced.

WEST BATHHOUSE—NORTH BUILDING
CHRONOLOGY OF DEVELOPMENT & USE (1953-PRESENT)

- Fortunately, the North building and north lobby are primarily intact. Alterations are primarily the result of deterioration or inappropriate repairs.
- The ceiling of the North lobby was painted, altering the appearance of the sand finished concrete and covering up the oak woodwork. The historic shallow Art Deco ceiling fixtures were also replaced with hanging fixtures with large shades.
- In the loggia, all but one of the historic Art Deco chandeliers have been lost.
- On the main façade the wood fascia board was enclosed or replaced with an inappropriate vertical board fascia. The two cast stone lanterns have also been lost.



North facade—2009. Note missing lanterns.



Loggia—2009. Note single chandelier remaining.



North Lobby—2009. Note painted ceiling and woodwork and replacement lighting.

WEST BATHHOUSE—OUTER COURTYARD
CHRONOLOGY OF DEVELOPMENT & USE (1953-PRESENT)

- As demographics and use patterns changed the changing area slowly fell into disuse. Bathing suits dried faster, styles changed and patrons began to wear the suits to the Park and not using the changing areas at all. The hundreds of changing rooms and lockers were no longer need.
- A limited number of new compact changing rooms were constructed directly behind the north building. Access points were limited.
- The new changing rooms were constructed in the 1980's. The buildings were constructed of a 'modern' poor substitute of Barbizon brick. Showers and changing areas were constructed of stainless steel or glazed block.
- The cabana style building were eliminated completely in the 1990's. Ghosts of the old buildings can still be seen on the perimeter walls. The paving also bears the marks of the buildings and patrons as well as the and original drainage design.
- Vast areas on each side of the outer courtyard are now used for maintenance storage.



Outer Courtyard—Former changing area c.2009.



Outer Courtyard—2009.



Outer Courtyard—1980's changing rooms c.2009.



Outer Courtyard—1980's Showers c.2009.

WEST BATHHOUSE SUMMARY OF EXISTING CONDITIONS

In 2009, a comprehensive existing conditions study was performed. The report found that the West Bathhouse was in poor condition. Throughout the building character defining features were threatened by widespread deterioration.

- Masonry Deterioration
 - Cast Stone
 - Barbizon Brick
 - Ohio Sandstone
 - Natural Stone
 - Terrazzo
- Roof & flashing failures
 - North Building
 - Loggia
 - South Building
- Structural Steel
- Architectural Woodwork
- Ornament, Lighting & Hardware

In 2010 multi-million dollar masonry restoration and stabilization project was undertaken by OPRHP. The project should address many of the most critical deterioration problems.



Structural Steel Deterioration (North Bldg. 2009)



Cast stone Deterioration (South Bldg. 2009)



Wrought Iron Deterioration (Perimeter Wall. 2009)



Roof leaks & Deterioration (Loggia. 2009)



Pavement displacement (Pool deck. 2009)



Steel lintel deterioration (South Bldg. South 2009)



Brick deterioration (Perimeter Wall 2009)

WEST BATHHOUSE (1930) LANDSCAPE PLAN

- The West Bathhouse featured a carefully designed landscape plan that incorporated plantings and hardscape elements. The landscape plan defined the area around the West Bathhouse and tied the area into the overall Beaux Arts Park plan. The Parterre style of landscaping used at the Central Mall area was also used around the WBH.
- The Bathhouse landscape included the pedestrian walkways that led from the parking fields on the other side of Ocean Parkway, a wide perimeter around the building on the north, east and west and the large south plaza.
- The WBH features a rectangular raised terrace along the south façade. The south wall of the terrace formed the north boundary of the south plaza. The south plaza is set between the WBH and the beach and Boardwalk/ocean. The plaza is 'embraced' by the long curved sections of the boardwalk that extended out from the WBH on the east and west. The curved sections of boardwalk terminated in awning covered boardwalk shelters. Beach umbrella rental stands were incorporated into the shelters.
- The plaza was divided into five sections. The central section extended directly out from the terrace and featured a wide expanse of lawn extending down to the beach. The two flanking sections of plaza also featured closely mown lawn. The sections to the east and west however, transitioned from lawn to beach grass.
- The landscape close to the building featured sections of lawn, pathways and sharply defined hedges. The hedges become larger and more wild as they extended away from the building.
- Potted plants were also used throughout the landscape—especially close to the building. Carefully sculpted shrubbery was set out in large Art Deco, cast stone planters.



WEST BATHHOUSE—LANDSCAPE

SUMMARY OF EXISTING CONDITIONS

The West Bathhouse landscape is in fair condition. The overall layout of the historic landscape is still intact but the many of the plantings and lawn features have been lost or have become overgrown.

Storm Damage:

Super Storm Sandy washed away soil, grasses and deposited sand on the south plaza between the beach and the WBH. This has eroded the clean lines of the plaza created by the contrast between the pathways and lawn and sand. The cooling effect of the vast expanse of lawn has also been lost.

Planting Loss:

- The clean, geometric lines of the carefully trimmed hedges and shrubs around the building have been lost. Trees and shrubs are now set in mulched planting beds and shaped into rounded and irregular forms. The overgrown planting that are too close to the building also trap moisture on the masonry accelerating deterioration.
- The original Art Deco planters still exist but no longer appear to be used.
- The slightly wilder sections of the landscape were also effected by time and storm damage. Many of the larger shrubs have survived but the varieties of beach grass along the perimeter are threatened. The beach grass helps keep the sand and soil in place preventing erosion and blowing sand.



WEST BATHHOUSE: USE, SIGNIFICANCE & PRESERVATION

SPACE & USE

Recommendation:

The West Bathhouse is currently greatly underutilized.

| Description | Sq. Foot (Aprox.) |
|-----------------------------------|-------------------|
| North Building Loggia: | 2000 sq. ft. |
| North Building Lobby: | 8400 sq. ft. |
| Inner Courtyard (Pool/Courtyard): | 50,000 sq. ft. |
| Outer Courtyard (Changing Area): | 50,000 sq. ft. |
| South Building Ground Floor: | 12,000 sq. ft. |
| South Building Terrace Level: | 7,000 sq. ft. |
| South Building 3rd Floor Terrace: | 5,000 sq. ft. |
| South Building Restrooms: | 6,500 sq. ft. |

**Note: A historic structure report for this building was completed in 2009.
For more information see:**

**The West Bathhouse at Jones Beach
A Historic Structure Report**

**By Erin Moroney
New York State OPRHP
Bureau of Historic Sites
December 2009**

SIGNIFICANCE

The West Bathhouse is significant:

1. As an important component of the formal Beaux Arts plan of Jones Beach State Park.
2. For its architectural design. The building reflected careful thought regarding use, layout, materials and ornamental design. These elements are skillfully used together to create a structure that works individually and as part of the overall park design.

Significant Elements include:

1. **Materials.** The use of specific materials was consistent throughout Jones Beach and helped maintain a sense of unity through the large park. Important materials uses at the EBH include Barbizon Brick, buff colored sandstone, cast stone and copper trim element.
2. **Design Elements.** Important design elements include:
 - Three part building structure (North building, Courtyard and South building).
 - Low horizontal massing of the building anchored by the square towers.
 - Symmetry of facades & spaces
 - Art Deco design elements
 - High level of ornamentation on primary elevations.
 - Original brick screen walls.
 - Screening of courtyard uses/structures.
 - Open Passage between courtyard and beach
 - Terraces with fixed frame canvas awnings
 - Landscape design, especially south plaza
 - High Style terrace level gallery (Marine Dining Room, Lobbies & dining rooms)
 - Incorporation of WBH landscape into JB
3. **Function & Design.** The relationship between design and function is significant. The level of ornament on the building reflects its use. The highly ornamented section along the ocean reflects a public use while the relatively unadorned brick screen wall represents a more utilitarian purpose.
4. **Period of Significance: 1930**

TREATMENT

Recommendations: Rehabilitation

Retention and preservation of Historic Materials

1. The impact of alterations, repairs and even code upgrades should be weighed in terms of their effect on historic fabric. Code requirements specifically the ability to meet health and safety, energy codes and ADA requirements should be addressed without damaging historic spaces, features or finishes.

Repair of Historic Materials and Features

1. Many important features are threatened by deterioration including the sandstone, Barbizon brick & copper trim features. When necessary deteriorated fabric should be replaced in kind but the primary goal should be the preservation of historic fabric.

Replacement of Missing Historic Features

1. The WBH has lost many of its significant features. Where possible historic documentation should be used to replicate losses due to deterioration or alteration. Missing or altered elements include:
 - Loggia & North Building Lobby
 - Terrace level of South Building
 - Ground level passages in South Building
 - Terraces with fixed frame awnings (45°)
 - Art deco design elements on north and south buildings (Lighting elements, masonry trim, finials)
 - Original style & configurations of doors and windows
 - Historic Landscape

Removal of Inappropriate modern additions/features

1. Door & windows should be replaced as their lifespan comes to an end with windows and doors that replicate the appearance of the original windows and doors.

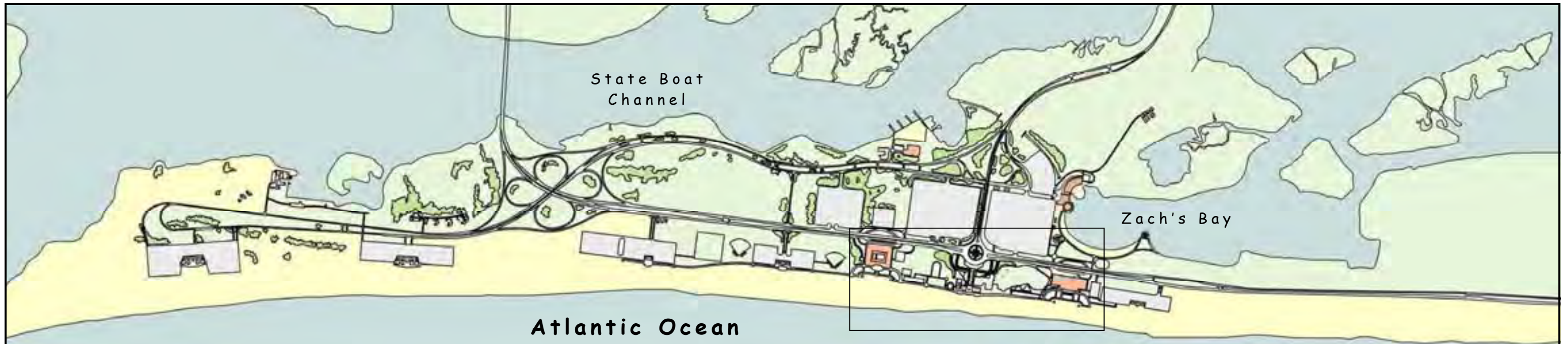

Zone 3: The Games Areas

*Jones Beach State Park
Wantagh, Long Island
New York*

*New York State Office of Parks,
Recreation & Historic Preservation*



Zone 3—Games Areas

Jones Beach was originally envisioned as a multipurpose Park with a range of entertainment possibilities. The large, open, expanses to the north of the Boardwalk on either side of the Central Mall were designed as activity/games areas. The East Games Area extends to the East Bathhouse landscape and the West Games Area reaches to the West Bathhouse landscape.

Originally the Games Areas featured shuffle board, archery, miniature golf, a pony track, horse shoes and a pitch and putt (short game golf). Over the decades some activities were discontinued and new activities were added. The types of activities provided were unified by a number of common characteristics; little infrastructure was required, no large or high support structures were needed & the nautical theme was applied whenever possible.

The Games Area was also designed to be a source of entertainment for those walking along the Boardwalk.

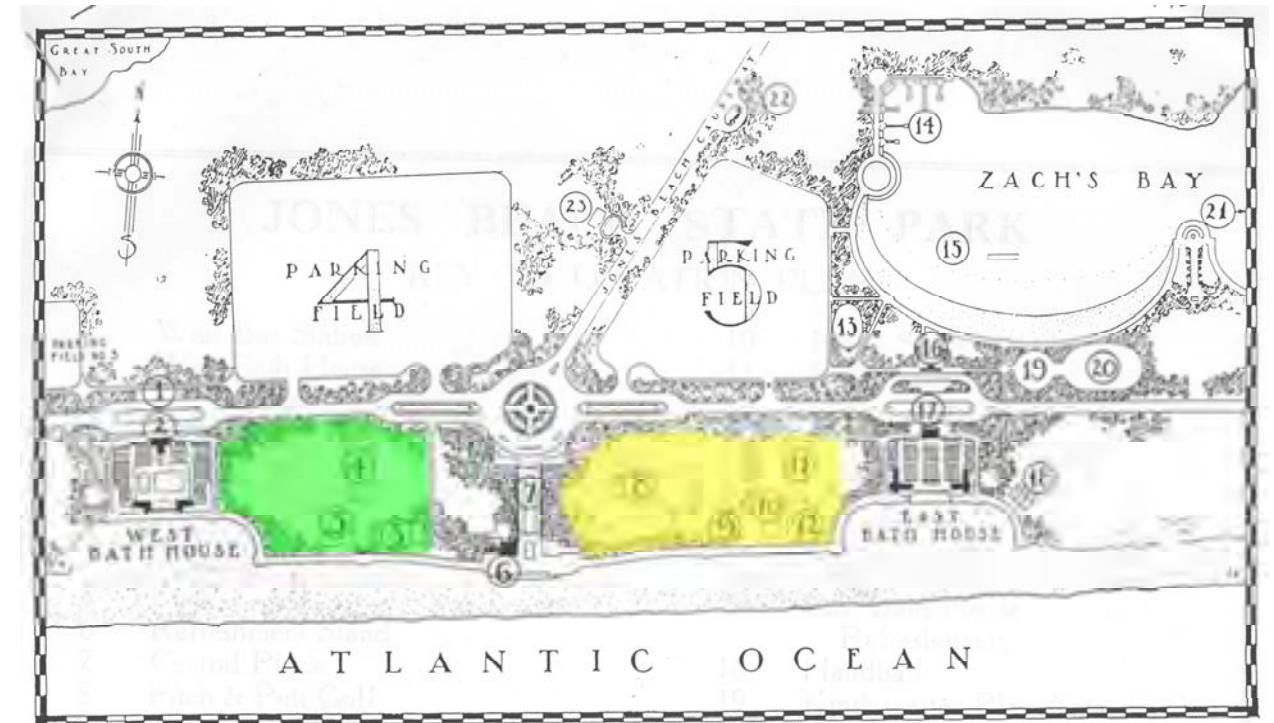

Pitch Putt, 1930's



Pitch Putt, 1930's



Pitch Putt, 2013

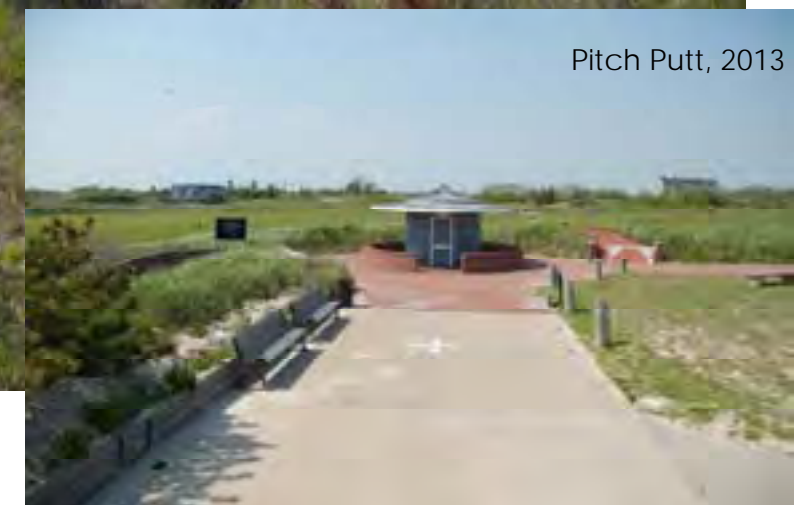

Pitch Putt, 2013

Zone 3 The Games Areas

The Games Area is a central component of the Beaux Arts plan of the Park, creating symmetrical, wide open areas between the Central Mall and the Bathhouses. The layouts of the East and West games areas are essentially mirror images of each other.

Landscape & Buildings:

- A wide open landscape that is generally flat to gently rolling with dunes, lawn, and landscaped areas. The entire landscape, even the slopes and gullies are man made. Each area is between 13 and 15 acres.
- A variety of activities ranging from court games to archery and golf. Activities generally did not require large infrastructure.
- "Buffer zones", primarily dunes or dense patches of hedges that are used to shield the area from parking lots, roads, service drives.
- Clearly delineated spaces within each area. Paving, shrubbery, and fencing were used to mark areas.
- A parterre style landscape was used in the areas adjacent to the Boardwalk. This connected the spaces to the landscape of the Central Mall and Bathhouse.
- Low, one story wood framed support structures that reference other buildings in the park (umbrella shacks and life guard shacks). Some structures were originally built into the hills (bunker style) as not intrude on the landscape.
- The pedestrian walkway was paved with red brick.

Layout

- A pedestrian walkway parallel to the Boardwalk with perpendicular walks that connected to the Boardwalk.
- A rectangular court area between the boardwalk and the pedestrian walkway. This area is dedicated to court games including scuffle board, table tennis and tennis (hard court). The area provides entertainment for the pedestrians on the boardwalk.
- Activity along the Boardwalk included horse shoes, archery and miniature golf. The original miniature golf course (East) was based on a nautical theme and called "Davey Jones' Locker".
- Less clearly delineated areas were located to the north of the pedestrian walkway. Activities in these areas include field games, play areas and golf.



"Davey Jones" Miniature Golf 1931

Pitch & Putt, 1946

Archery, 1936

Zone 3—The Games Areas:

- The areas between the pedestrian walkway and the Boardwalk was designed to be viewed from the Boardwalk: providing entertainment for both the participants and bystanders.
- The level area was created approximately 4-6' below the boardwalk.
- The area was primarily used for court games; shuffle board (both East & West), and horse shoes (East), archery (East & West) and miniature golf (East). The original miniature golf course reflected the Park's nautical theme, "Davey Jones Miniature Golf Course" (1931).
- Over time additional court games were added to the area including tennis and table tennis.
- Small single person wood frame ticket booths were located throughout the Games Areas. The buildings featured windows and doors with small square lights and decorative finials on the copper roof.
- The courts were lit at night by numerous light poles set along the Boardwalk. Each light pole featured three lamps (see below). The lights were directed to the court—away from the Boardwalk. The original light poles and lanterns were replaced in the 1950's.
- Custom designed score boards and signs were also used.



Ticket Booth c. 1936



Table Tennis & Tennis c.1946



Shuffle Board c. 1946



Band Shell c. 1940's



Zone 3—The Games Areas:

- One of the main features of the Games Area (west) was the Band Shell.
- The Band Shell is visible from the Boardwalk but accessed from the pedestrian walk in the West Games Area.
- The Band Shell itself (the structure) has undergone many permutations over the years. Beginning with a temporary structure in the 1930's and evolving to a more permanent building in the 1950's.
- A paved platform is set in front of the Band Shell and surrounded on three sides with bleachers. The style, size and type of bleachers has changed over the years.
- The Band Shell has been used for many activities including: dancing, music, roller skating, play ground and performances of all kinds.



Band Shell c. 1960



Band Shell c. 1940



Pitch Putt Starter's Shack c.1940's



Pitch Putt Course c.1940's



Pitch Putt Course c.1940's

Zone 3—The Games Areas

- The area to the north of the pedestrian walkway featured golf and field games.
- The East Games area featured one major activity, the Pitch Putt, in addition to a small playground area.
- The Pitch Putt has been a major feature of the Games Area (East) since the 1930's.
- The Pitch Putt is a short game golf course. The 18 hole course features tees, sand traps, putting greens and hazards. While the course itself featured grass, dunes and sand, the perimeter of the course featured a traditional Parterre landscape. Carefully sculpted hedges, lawn and paved areas were used to define the boundaries of the course.
- The Starter's Booth was located on the pedestrian walkway. The low, one-story, circular building featured narrow columns of lockers set into the building. The building also featured an open service counter for tickets & club rental. The building featured a stepped sheet metal (copper) roof with raised seams. A low brick wall encircled the building.
- The playground area featured swings, rocking horses, see-saws and other traditional playground equipment.

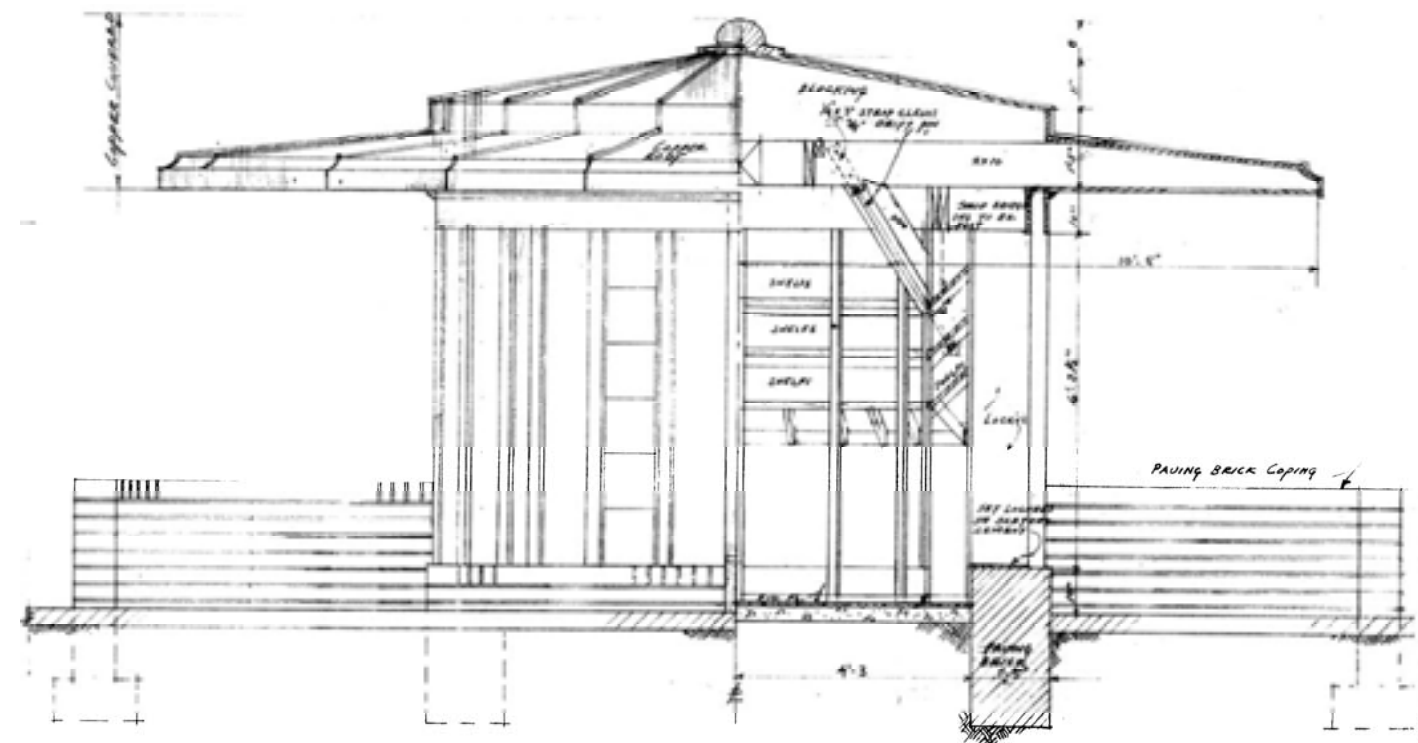

Pitch Putt Starter's Shack—original drawing.

Zone 3—The Games Areas

Field Games:

- The area to the north of the pedestrian walkway featured golf and field games.
- Field games included baseball, softball and basketball. The type, size and exact location of the fields have changed over time.
- During some periods of high popularity the fields featured viewing stands.

Roller Skating:

- Roller skating was also a major feature of the West Games Area. Roller skating evolved from a simple square paved lot, to a indoor arena to a large outdoor skating rink. The skating rink was eventually converted into volleyball fields.
- The support buildings were small, low, one-story structures with wood siding. Building were generally either rectangular or round with flat roofs.



Roller skating c. 1930's



Roller skating building c. 1952



Roller Rink c. 1946



Baseball Tournament c. 1940



Basketball Tournament c. 1940

Zone 3—The Games Areas

West Games Area:

- The West Games area lacked a successful, large (square footage) central feature like the Pitch Putt in the East Games Area. As a result the West Games Area featured a number of seasonal or annual exhibits including an “Indian Village” and Circus. The “Indian Village”, depicted a 1950’s interpretation of a prairie style Native American village. The Village featured teepees and daily shows with re-enactors.

Chronology of Activities:

| 1930-50 | | 1950’s—60’s | | 2013 | |
|--------------------|----------------|--------------------|---------------|-----------------------------|---------------|
| West Games | East Games | West Games | East Games | West Games | East Games |
| Shuffle Board | Shuffle Board | Shuffle Board | Shuffle Board | Shuffle Board | Shuffle Board |
| Archery | Archery | Archery | Archery | Volleyball | Pitch Putt * |
| Pony Track | Pitch Putt | Roller Skating | Pitch Putt | Miniature Golf | Basketball |
| Seasonal Events | Horse Shoes | “Indian Village” | Horse Shoes | Band Shell/Dancing | |
| Roller Skating | Miniature Golf | Miniature | Basketball | Playground | |
| Band Shell/Dancing | Baseball | Band Shell/Dancing | Baseball | | |
| Playground | Playground | Playground | Playground | | |
| | | | | *Closed due to storm damage | |



1950’s Map of Jones Beach

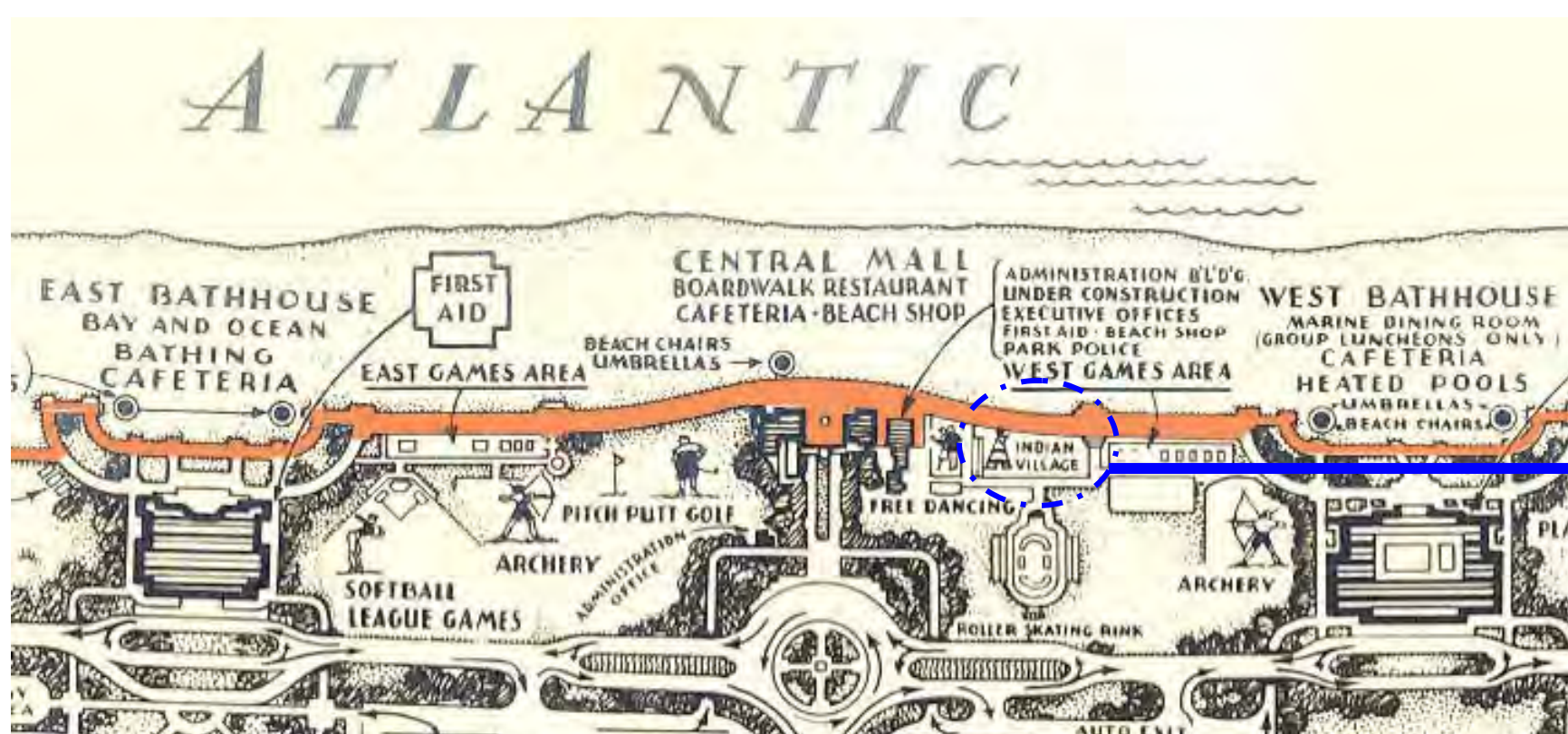

1950 Map of Jones Beach



1950’s Map of Jones Beach

Zone 3—The Games Area Existing Conditions

The Games Area

The integrity of the Games Area has slowly been eroded by the loss of the historic landscape, the addition of unsympathetic/inappropriate features and deterioration.

While much of the deterioration is the result of Super Storm Sandy, the Games Area has been falling into disuse since the 1980's resulting in neglect and further loss.

Despite the loss and deterioration, the fundamental character and design of the space is primarily intact. The basic plan remains, including the pedestrian walkways, hard courts and the open expanse of green landscape.

Inappropriate Additions

- New support/activity buildings that do not reference the character, massing or scale of the original buildings in the Games Area. Examples include the West Games comfort station and gazebo.
- The addition of playground equipment (west) that is too high, too vibrantly colored and constructed of inappropriate materials.
- Stylistically and functionally inappropriate lighting fixtures that do not properly illuminate the Games Area.

Deterioration

- Super Storm Sandy caused extensive damage to the Pitch Putt course. The course is currently closed.
- The clearly delineated landscape create by the Parterre design has slowly been eroded by the loss of planting. This has also resulted in the loss of grass, soil and encroachment of sand.



East Games Area , 2013
Pitch Putt



East Games Area , 2013
Pedestrian walkway and hard courts



East Games Area , 2013
Pitch Putt



West Games Area , 2013
Comfort Station



West Games Area , 2013
Playground

ZONE 3 THE GAMES AREA : USE, SIGNIFICANCE & PRESERVATION

SPACE & USE

Recommendation: The Games Area is currently underutilized. Many of the historic activities are no longer offered, popular or safe (archery).

East Games Area:

13-15 Acres

Activities:

Shuffle Board

Pitch Putt* (Currently closed due to storm damage)

Basketball

West Games Area:

13-15 Acres

Activities:

Shuffle Board

Volleyball

Miniature Golf

Band Shell/Dancing

Basketball

Playground

SIGNIFICANCE

The Games Areas are significant:

1. As an important component of the formal Beaux Arts plan of Jones Beach State Park.
2. For the landscape design. The landscape plan reflects careful thought regarding use, layout, planting and design. These elements are skillfully used together to create a harmonious and unified landscape.

Significant Elements include:

1. **Plan/Layout.** Spatial organization within the Games Area was designed to provide space for activities as well as provide entertainment for pedestrians on the Boardwalk. The area was also designed to be a generally open green space with carefully delineated activity areas.
2. **Landscape Plan.** A formal Parterre landscape design was used to delineate spaces adjacent to the boardwalk. Carefully trimmed hedges, walkways, and lawn areas were used to define spaces.
3. **Materials:**
 - **Buildings:** Wood (frame, cladding and trim) with copper or wood shingled roofs.
 - **Paving:** Red brick walkways, concrete courts.
 - **Plantings:** lawn, low trimmed hedges, beach grass. Large patches of shrubbery along zone perimeter.
 - **Fencing:** Wood picket, chain link, rope.
4. **Architectural Style/Scale:** The building are typical Jones Beach support structures, small, one-story with flat roofs. The buildings are either circular or rectangular with decorative wood trim.

Period of Significance: 1930-1951

TREATMENT

Recommendations: Rehabilitation

Retention and preservation of Historic Materials

1. The impact of alterations, repairs and additions should be weighed of their effect on the Park design and historic fabric.

Repair of Historic Materials and Features

1. Historic landscape features are threatened by deterioration including the Pitch Putt, remaining hedges and lawn areas.

Replacement of Missing Historic Features

1. Many of the original activities in the Games Area did not require extensive infrastructure (exception of Pitch Putt). The primary feature was the designed landscape that allowed a variety of activities to occur while maintaining a harmonious and unified space. Re-establishment of the formal landscape plan is critical to preserving the Games Area.



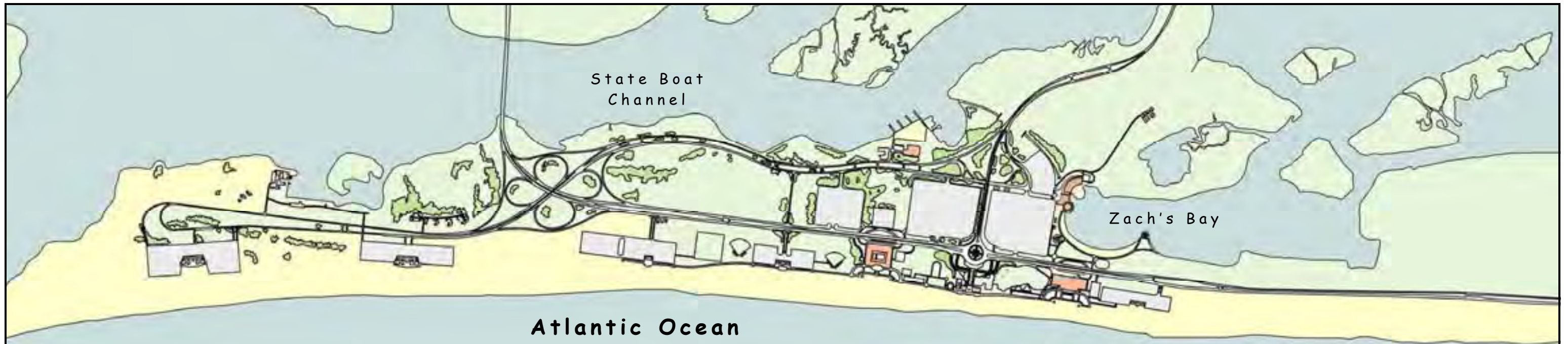

Zone 4: Fields & Comfort Stations

*Jones Beach State Park
Wantagh, Long Island
New York*

*New York State Office of Parks,
Recreation & Historic Preservation*



Zone 4—Parking Fields & Comfort Stations

First and foremost, Jones Beach was facility designed for the automobile age. Parkways, causeways, and bridges were designed and completed to bring the masses to Jones Beach. They were to arrive not by train, trolley or bus but in the personal automobile. Therefore, Jones Beach was designed to accommodate thousands of automobiles.

Vast parking fields were constructed on the north side of the Ocean Parkway while smaller parking fields with comfort stations were set on the south side of the Parkway. The north parking fields connected to the beach via pedestrian passage ways that ran under Ocean Parkway.

Comfort Stations along the beach provided a place to change, facilities and snacks bars. The Comfort Stations alleviated congestion at the Central Mall and Bathhouses while also provided services nearer to patrons at the far east and west ends of the Park.



Parking Sign, c. 1930's

Parking Field 5, 1936



Comfort Station, 1950's

Zone 4 The Parking Fields & Comfort Stations

The Parking Fields can be divided into two categories, those north of Ocean Parkway and those south of the Parkway.

North of Ocean Parkway:

- Parking Fields without companion comfort stations.
- The Parking Fields are very large, flat and open.
- The Parking Fields are paved with the original 1930 concrete.
- The Parking Fields do not include lighting, curbs, posts, islands or any other three dimensional intrusions.
- Parking lines are painted directly on the concrete. The Parking fields are arranged with paired rows of spaces set perpendicular to Ocean Parkway (excluding overflow).
- The Parking Fields are connected to the Central Mall or Bathhouses via passages that run under Ocean Parkway.
- Ticket Booths were located at the entrances to the Parking Fields.

South of Ocean Parkway:

- Parking Fields feature companion comfort stations.
- The comfort stations are located at the south end of the Parking Field.
- The Parking Fields are large, flat and open.
- The Parking Fields are paved with concrete.
- The interior of the Parking Fields do not include lighting, curbs, posts, islands or any other three dimensional intrusions.
- Light posts and curbs are used around the perimeter of the Parking Field.
- Parking lines are painted directly on the concrete. The Parking fields are arranged with rows of spaces set parallel to the coast.
- Ticket Booths were located at the entrances to the Parking Fields.



Parking Field 5, 1936

Parking Field & Comfort Station 2, 1960's



Zone 4—The Parking Fields & Comfort Stations Chronology of Development & Use:

- 1929 Construction of Parking Field 4
- 1930 Construction of Parking Field 5
- 1931-32 Parking Fields 4 & 5 complete (12,000 car capacity)
- 1933 Parking Fields enlarged by 2,000 cars
- 1935 Construction of Parking Field 3
- 1936 Construction of Parking Field 10
- 1930's Construction of Parking Fields 2 & 6
- 1947-48 Parking Field 6 enlarged by 800 cars
- Parking Field 2 enlarged
- Parking Field 5 enlarged by 1000 cars
- 1949-50 Construction of Comfort Stations/Refreshment Stands at Fields 2 & 6
- 1950-51 Construction of Parking Field 1 (1,300 car capacity)
- 1950's Construction of Comfort Station/Refreshment Stand at Field 1



Evolution & Development of Parking Field & Comfort Stations



Aerial View c. 1932. Field 4 complete, Field 5 under construction



Aerial View c. 1958. Field 4, Field 5 & corner of Field 3

Zone 4—The Parking Fields Ticket Booths

The Parking Fields originally featured small Art Deco style ticket booths at the entrances.

Description—1930's

- One-story, oblong structure set on a raised concrete pad.
- The upper half of the structure was glassed in with bowed glass windows at the front and back.
- Wood rails divided the glass into horizontal bands, which reinforced the modern, streamlined look.
- The lower half of the booth featured wood boards set in horizontal bands.
- The ticket booths featured copper roofs with projecting cornices that wrapped around the building. The copper roofs came to a very shallow peak with a ridge.
- Each ticket booth featured two ticket windows, one on each long side to facilitate traffic on both sides of the booth.

Alterations & Additions

- The original Art Deco ticket booths were replaced with small, one story wood frame structures with gabled roofs.
- In 1953, new toll plazas were installed at the entrances to the park. The toll plazas are connected to brick building set on the side of the road.
- New ticket booths are currently under design.



Ticket Booths, c.1930's



Toll Plaza & attached building 2013



Ticket Booths, c.1930's



Watchman's Booth, 2013

This historic structure (1930's) is currently being re-used as a ticket booth at one of the Parking Fields. The structure octagonal structure is constructed of bronze and glass with wide overhanging eaves. The building also features it's original green glass lantern.

Zone 4—The Parking Fields & Comfort Stations

Chronology of Development & Use:

Two types of Comfort Station were constructed at the Parking Fields. The Comfort Stations at Parking Fields 2 & 6, which were constructed at the same time, were based on the same building plan. The Comfort Station at Field 1 was constructed slightly later and featured a different design.

Comfort Station—Fields 2 & 6

- One and a half story, low horizontal building with a hipped roof.
- Primarily identical facades (north and south)
- Open pass-through concept, open passageways through the center of the building from the north to the south. These passages provided a clear view from the north to the ocean.
- Square sandstone towers flanking the main entrance with flagpoles.
- Sandstone piers dividing the central section of the building.
- Horizontal design reinforced by the sandstone bands that run through the windows.
- Constructed of Barbizon Brick and Ohio Sandstone.
- Originally featured a wood shingle roof.



Comfort Station, c.1960's

Comfort Station—Field 1

- One and a half story, low horizontal building with a hipped roof.
- Hierarchy of facades, with the primary elevation of the beach (south elevation)
- Long shed style dormer on the south elevation.
- Sandstone piers flanking the main entrance.
- Constructed of Barbizon Brick and Ohio Sandstone.
- Originally featured a cedar shingle roof.
- Designed by Skidmore, Owings & Merrill, Architects & Engineers, 1951



Parking Field 1, Comfort Station, c.1951-2

Comfort Station Under Construction c.1950



Zone 4—The Comfort Stations Parking Fields 2 & 6

Original Construction (1950)

- The Comfort Stations originally featured a small number of restrooms and a snack bar/soda fountain area.
- The snack bar was located in the open central section of the building.
- The restrooms were located in the flanking wings.
- The half story above the central section was used for storage.
- The open passages in the central section provided a clear view thru the building to the ocean. Roll down doors were used to secure the opening when the structure was closed.

Additions/Alterations

- Doors were installed on the central bay openings. The door reduced the open breezeway effect of the original design.
- In the 1980's the buildings were expanded. Low, one-story wings with flat roofs were added to the east and west. The additions were constructed to expand and update the restroom facilities.
- The wings were constructed of a modern, poor match for the historic Barbizon brick and featured limited sandstone trim.
- The wings featured open passages connecting the north and south sides of the buildings.
- A concession windows was installed in the sandstone towers on the south façade of the buildings.
- The small cast stone windows on some of the other towers were replaced with large metal windows with reflective glass.



Comfort Station, south elevation 2009



Comfort Station, north elevation 2013



Comfort Station c.1960's
Materials



Honed Sandstone
 Rock Faced Sandstone
 Cast Stone
 Barbizon Brick

Zone 4—The Comfort Stations Parking Fields 2 & 6

Original Construction (1950)

- The Comfort Stations were constructed of the requisite Jones Beach Barbizon Brick and sandstone, a different type of sandstone and finish was used.
 - Rock-faced sandstone was used for the towers and piers. This sandstone is a slightly different variety than used in the early building campaign at Jones Beach (1930's). It is possible that the type and color range originally used in the park was no longer available or a different type of stone was desired. The sandstone is primarily a consistent light yellow sandstone.
 - A honed (smooth) sandstone finish was also used on the building. The honed sandstone was same color and variety of sandstone used for the rock faced portion of the building. The honed sandstone was used for the horizontal banding at the windows and at the cornice.
- The horizontal bands of sandstone reinforced the horizontal character of the building.
- Cast stone caps were used on the towers and Barbizon brick was used for the remainder of the building façade, excluding wood trim.
- The windows were set behind the bands of sandstone and tilted in. Each window featured six fixed rectangular lights.
- The sandstone towers each featured a long narrow gun slit window. This window was also divided by bands of honed sandstone.
- The sandstone towers projected from the building in a series of steps. The recessed areas also the façade were designed as planting beds. The towers also featured flagpoles set in recessed niches.

Sandstone Tower & Planting Bed, 2013



Sandstone Tower & Flagpole, 2013



Sandstone banding at windows, 2013



Comfort Station—Parking Field 1 c.1950's

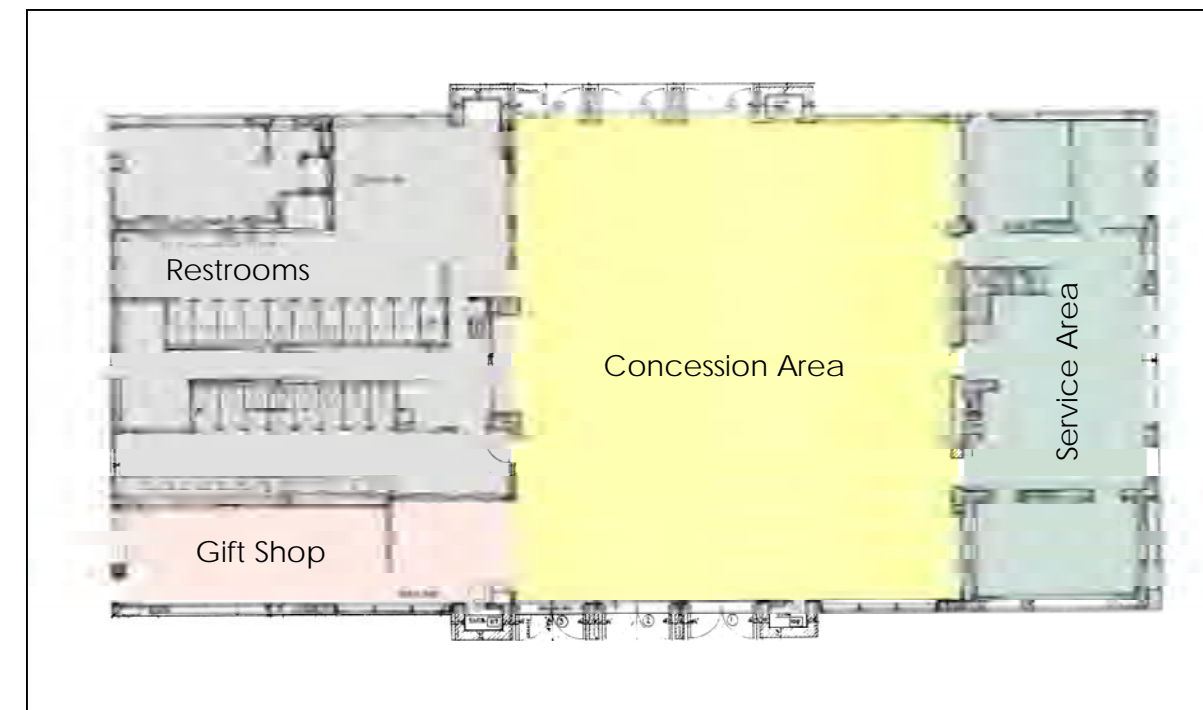

Comfort Station—Parking Field 1, Floor Plan c.1951

Zone 4—The Comfort Stations Parking Fields 1

Original Construction (1950)

- This Comfort Station originally featured a small number of restrooms and a snack bar/ soda fountain area and gift shop.
- The snack bar was located in the open central section of the building with service counters on the west elevation.
- The restrooms were located in the east wing.
- A gift shop was also located in the east wing along the south elevation.
- The west wing housed the concession storage/kitchen and service area.
- The half story above the central section was used for Park offices/storage.

Additions/Alterations

- In the 1980's the buildings were expanded. Low, one-story wings with flat roofs were added to the east and west. The additions were constructed to expand and update the restroom facilities.
- The wings were constructed of a modern, poor match for the historic Barbizon brick and featured limited sandstone trim.
- The original doors on the central section of the building were replaced.



Comfort Station, north elevation 1996—*National Register Nomination Image*



Detail of severe sandstone pitting (south elevation). The surface should be smooth. 2009

The Comfort Stations Parking Fields 2 & 6 Existing Conditions

Overall the Comfort stations at Fields 2 & 6 are in fair condition. Deterioration, however, is a problem for specific materials at certain locations.

Sandstone Pitting

- The sandstone that was procured for the construction these buildings was from a different source than the Ohio sandstone used in the 1930's at Jones Beach.
- This sandstone is unfortunately much *less* durable.
- On the south elevations (ocean side) the blowing beach sand has caused severe pitting of the sandstone. Nearly 100% of the exposed sandstone on the south elevation is in poor condition.
- The rock-faced sandstone on the towers is less visibly deteriorated than the honed (smooth) sandstone used on the rest of the façade.

Sandstone Cracking

- The sandstone used to span the windows does not appear to have the proper tensile strength. This has led to cracking at multiple locations

Biological Growth

- Biological growth is primarily a problem on the rock-faced sandstone. Here the irregular surface allows particles to cling to the stone and grow. Biological growth is a problem because it traps moisture on the stone leading to more rapid deterioration.

Wood Deterioration

- Extreme weathering and poor maintenance has led to the deterioration of wood trim elements including the cornice and fascia.



Biological growth— sandstone towers (north elevation). 2009



Sandstone & Wood deterioration (south elevation). 2009

ZONE 4 THE PARKING FIELDS & COMFORT STATIONS : USE, SIGNIFICANCE & PRESERVATION

SPACE & USE

Parking Fields:

The Parking Fields are currently and have historically been used as parking fields.

| Parking Field | Square Foot (Estimated) |
|---------------|-------------------------|
| Field 1 | 700,000 sq. ft. |
| Field 2 | 400,000 sq. ft. |
| Field 3 | 715,000 sq. ft. |
| Field 4 | 1.5 million sq. ft. |
| Field 5 | 1.3 million sq. ft. |
| Field 6 | 350,000 sq. ft. |
| Field 10 | 60,000 sq. ft. |

Comfort Stations

The Comfort Stations are currently and have historically been used as parking fields. The building provide restrooms and snack bars.

SIGNIFICANCE

The Parking Fields are significant:

1. As an important reminder of the importance the automobile in the creation and success of Jones Beach.
2. For the architectural design. The Comfort Stations and original ticket booths clearly contributed to the Jones Beach aesthetic by the use of materials and Art Deco architectural style.

Significant Elements include:

1. Plan/Layout.

Parking Fields:

North of Ocean Parkway.

- Paved parking area only, parking aligned perpendicular to the Parkway & as vast open spaces with limited intrusions.

South of Ocean Parkway.

- Comfort station & parking field, parking aligned parallel to the Parkway & as vast open spaces lined with curbs and light poles.

Comfort Stations:

- Open central passage with views to the north and south.

2. Materials:

- Comfort Stations: Barbizon brick with sandstone.
- Ticket Booths: Copper roofs, glass and wood trim.
- Paving: concrete

3. **Architectural Style/Scale:** The buildings maintain the low, horizontal character of the structures along the beach. The building also feature the characteristic open passages between elevations.

Period of Significance: 1930-1953

TREATMENT

Recommendations: Rehabilitation

Retention and preservation of Historic Materials

1. The impact of alterations, repairs and additions should be weighed of their effect on the Park design and historic fabric. Code requirements specifically the ability to meet health and safety, energy codes and ADA requirements should be addressed without damaging historic spaces, features or finishes.

Repair of Historic Materials and Features

1. Historic landscape features are threatened by deterioration including the honed sandstone and wood fascias. The sandstone on the south elevation is especially threatened.
2. When necessary deteriorated fabric should be replaced in kind but the primary goal should be the preservation of historic fabric.

Replacement of Missing Historic Features

1. The original ticket booths were a key feature of the Parking Fields. In addition to providing a necessary function the structures brought the character of the Park to the otherwise unembellished Parking Fields.

Removal of Inappropriate modern additions/features

1. The doors in the Comfort Station should be replaced (when necessary) with doors the better achieve the sense of openness intended by the architects.
2. The windows and service windows installed in the sandstone towers should be removed.

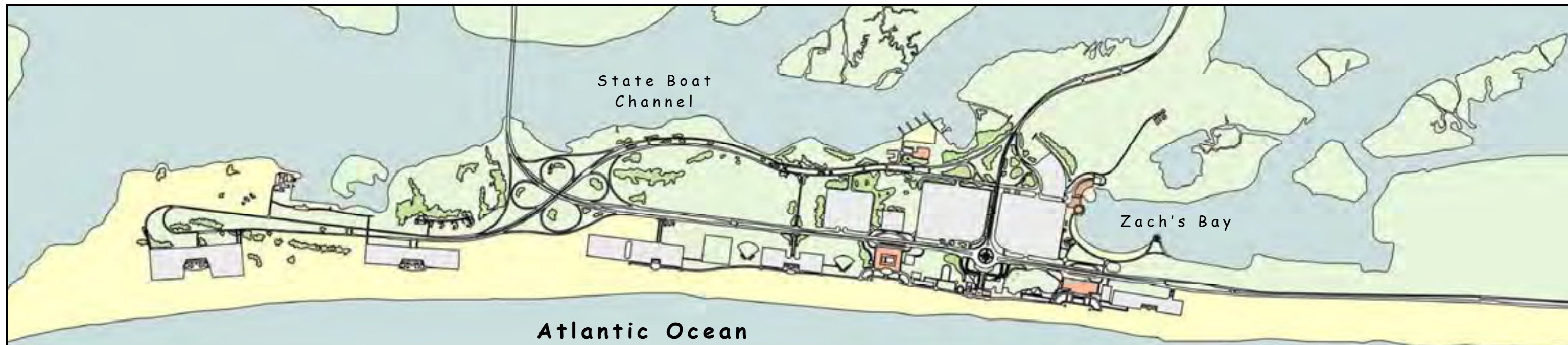

Zone 5: Infrastructure (Buildings)

*Jones Beach State Park
Wantagh, Long Island
New York*

*New York State Office of Parks,
Recreation & Historic Preservation*



Police Headquarters
Staff Residences (3)

Maintenance Building

Electrical Vault

Sewage Treatment

High Hill Maintenance
Complex

*Please Note: Additional Buildings not shown due to map scale.

Zone 5—Infrastructure

Jones Beach State Park was designed to serve hundreds of thousands of patrons in a single day and millions of people over a season. To meet this goal, the Park required a vast infrastructure network similar to that of a small city. Infrastructure in the Park included maintenance areas, concession support areas, water and septic services, electrical service, Police, and staff housing.

Additional infrastructure not fully explored in this report includes the unprecedented (in recreation) engineering feat of the construction the island itself from a chain of shifting barrier islands, or the building of a impressive system of causeways, parkways and bridges.

The beauty and harmony expressed in the architecture of the key buildings like the Water Tower of West Bathhouse was carried through all aspects of the Park's Infrastructure; from the Police Headquarters to the sewage holding tanks.

Parking Field 5, 1936

Sewage Treatment Plant c.1950

Zone 5 Infrastructure

The Park's infrastructure discussed in this section includes building and spaces that add to the significance of the Park and were constructed during the period of significance 1925-55.

The infrastructure can be divided into two categories:

Public Buildings: building that were designed to be seen and actively used by the public.

- Police Headquarters
- Gas Stations

Service Building: building or areas that provide necessary functions but are not be accessed by the general public.

- Maintenance Storehouse
- Commissary
- Sewage Treatment Facility
- High Hill Maintenance Complex
- Pump Houses
- Electrical Vaults
- Fort Benedict Reservoir
- Watchman's Booths
- Staff Residences

Gas Station & Pump House c.1930's.



Police Headquarters' 2013 .



Maintenance Storehouse & Park's staff c1936.



Sewage Treatment 1950's .



Police Headquarters' under construction (south elevation) 1937.



Police Headquarters' - north elevation 2013

Zone 5—Infrastructure

Police Headquarters

The Police Headquarters is an Beaux Arts building with Art Deco trim. The building is located at the west end of the Park on the north side of Bay Parkway.

Description—1937

- Two-story, three bay wide structure with one-story flanking wings. The central bay of the building features a slightly projecting rectangular tower.
- The building is constructed of Barbizon brick with cast stone trim. Cast stone is used for the lintels, sills, cap stones, niches, blocks and decorative banding. The cast stone lintels on the first floor features Art Deco relief; zigzags, chevrons etc.
- Decorative brickwork was used in addition to cast stone to call out elements and add ornamentation to the building.
- The building originally featured twelve-over-twelve, double hung wood windows or divided light, wood casement windows.
- Cast stone lintels with dentils are set over the deeply recessed doors.

South Elevation

- On the south elevation a large, decorative cast stone emblem is set at the top of the tower. The emblem represents the seal of New York.
- Cast stone niches were set into the brick parapet. Roof drains were built into the niches with external copper downspouts with decorative leader boxes.
- A entrance bay is located on the east bay and featured bronze lanterns on the sides of the door.

North Elevation

- The main entrance is located on the south façade under a large cast stone arch. The arched opening is set between two brick towers that project from the main façade.

Alterations

- All of the windows have been replaced. The replacement windows do not match the configuration, style or reflective quality of the original windows.
- The original doors have also been replaced. The doors are now almost flush with the building façade and do not reflect the historic configuration.
- The original bronze lanterns at the doors have been replaced with light bubs in aluminum cages.
- Inappropriate light fixtures have also been installed along the parapet on the south elevation.
- Air conditions are installed in many of the windows.

Condition

- Overall the Police Headquarters appears to be in generally good condition.
- The cast stone emblem of the seal of New York has extensive copper staining. The green staining is so prominent that it is visible from several thousand feet away.
- Minor efflorescence on the brick is visible as a result of water inflation at the parapet.



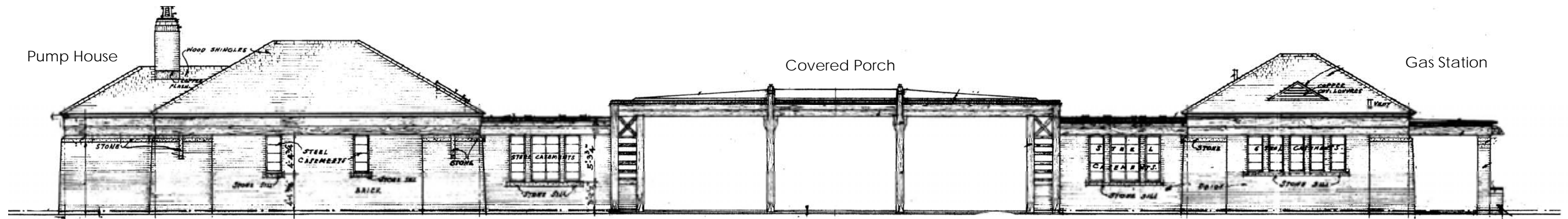

Gas Station & Pump House—original drawing 1933.

Zone 5—Infrastructure

Gas Station & Pump House

The Gas Station and Pump House were constructed to serve two distinct purposes. The pump house was built to pump water through the Park. The Gas Station was built to provide a rest stop and gas station on the route to/from Jones Beach on the Watauga Parkway. The Gas Station provided restrooms and Police and staff offices.

Description—1930's

- The Pump House and the Gas Station were designed as a single building connected by a three bay wide covered porch.
- The building was designed by Herbert Magoon, AIA & approved by W. Earle Andrews in 1933.
- The buildings are primarily constructed of Barbizon brick. The wall of the buildings feature battered brick piers similar to those used on the Bathhouse.
- The porch that connected the buildings featured wood posts, fascias and distinctive cross bracing. The bracing was similar that used on other early Park buildings including the 1929 restaurant at the Central Mall.
- The area under the porch was paved with flagstones.
- Each small, one-story building features attached flanking wings. The wings were either brick or open porches supported by brick piers.
- The central section featured a wood shingled hipped roof while the flanking wings had flat roofs.
- The buildings featured cast stone trim including window sills, lintels, cornices and cap stones.
- Copper flashing was used extensively on the buildings including on the fascia of the wood porch.
- Decorative wood trim was applied over the brick on one end of the Gas Station.
- The windows were originally long narrow steel casement. The building also featured skylights.
- The doors were wood panel with divided lights in the upper half.

Alterations

- The Gas Station section of the building is currently vacant and the plaza around the building is no longer open to the public.
- The covered wood porch that connected the two buildings has been removed. The only evidence that remains that the two buildings were connected is the deteriorated stone plaza between the building.
- On the Gas Station many of the windows have been sealed with brick. The remaining windows on the Gas Station and Pump House have been boarded up.
- The applied wood trim has been removed.
- The landscaped plaza around the buildings has also been lost.

Condition

- Overall the Gas Station & Pump House are in poor condition.
- Vegetation is growing out of the roof, cornice and brickwork.
- Water damage has caused extensive deterioration of the fascia boards and wood trim.
- The wood framing was also left exposed when the wood porch connecting the building was removed. This has led to deterioration and water infiltration.
- The masonry is in especially poor condition:
 - The brick piers supporting the porch on the Gas Station are in very poor condition. The piers show evidence of severe cracking and displacement.
 - Cracks resulting from differential settlement are visible in many locations.
 - Spalling brick and cracked brick.
 - Efflorescence resulting from water infiltration
 - Areas of brick loss have also been repaired with inappropriate materials.



Zone 5—Infrastructure

Storehouse

Jones Beach was designed to be incredibly self sufficient. The Storehouse was the central location for all of the Park's trades. Everything that could be done 'in house' was—from carpentry to tailors was housed in the Storehouse. The building housed the Park's fire truck and ambulance, as well as the awning shop, uniform tailor, sign shop, & machine shop.

The Storehouse is one of the larger buildings at Jones Beach, with over 40,000 square feet of interior space. The building is located on the north side of Bay Parkway, between the Parkway and the Boat Channel.

Description—1930's

- The building was designed by F. L. Gregory, AIA & approved by Sidney Shapiro, Architect/Engineer in 1934.
- The Storehouse is roughly horse shoe shape (with one end shorter than the other) in plan. The 'open' end of the horse shoe is enclosed with a brick screen wall. Large hinged gates provided access to the central courtyard.

Central Block

- The core of the building was used for loading and receiving. The building also housed a large storage area, the tailor/uniform office, laundry storage, maintenance office and building utilities.
- The Central portion of the building is a roughly rectangular, one-story with 18' ceilings.
- The main 'receiving' entrance is centered on the façade and outlined with a corbelled brick arch over the opening. The entrance is flanked by stepped brick towers with cast stone capstones.
- The exterior walls (not courtyard) feature battered brick piers at regular intervals.
- The windows are set in groups of three with cast stone sills and lintels. The windows were originally casements with fixed transoms.
- The buildings parapet is marked by a soldier course of brick.
- A copper clad clerestory/cupola ran the length of the building.
- The building is constructed of Barbizon brick with cast stone and copper trim.



Storehouse, 2013



Aerial View of Storehouse, 1949

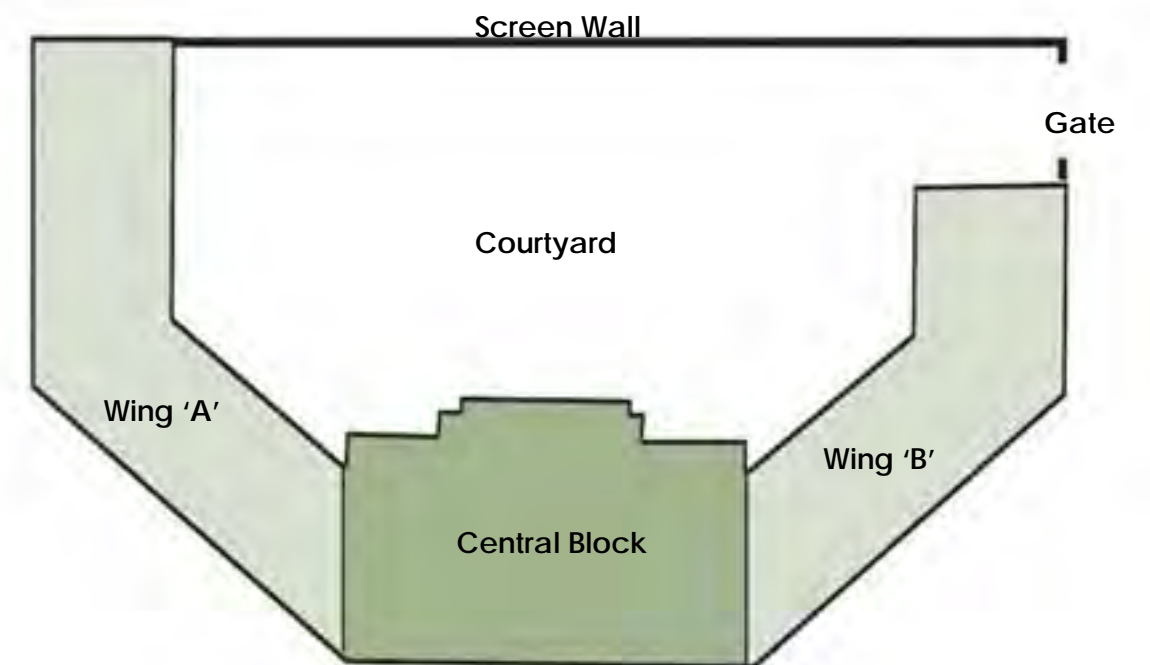

Sketch of building plan.



Commissary, 2013

Zone 5—Infrastructure Commissary

The Commissary was constructed to serve as temporary delivery or storage area for Park's concessions. The building is currently used for maintenance storage.

The Commissary is located to on the north side of Bay Parkway, between the Parkway and the Boat Channel to the west of the Storehouse.

Description—1930's

- The Commissary is a large one-story rectangular building with a flat roof.
- The building was constructed in 1935.
- The building is fairly simple, constructed of Barbizon brick with cast stone sills and cap stones.
- The building has a concrete water table.
- Two facades feature loading docks with a projecting roof.
- The windows and doors have all been replaced.
- A number of windows have also been replaced with metal vents.

Alterations

- The building is currently used for maintenance storage and is not frequently accessed.
- The windows have all been replaced.
- The doors have also been replaced.

Condition

- Overall the Commissary is in poor condition.
- The masonry is in especially poor condition:
 - Cracks resulting from differential settlement are visible in many locations.
 - Spalling brick and cracked brick.

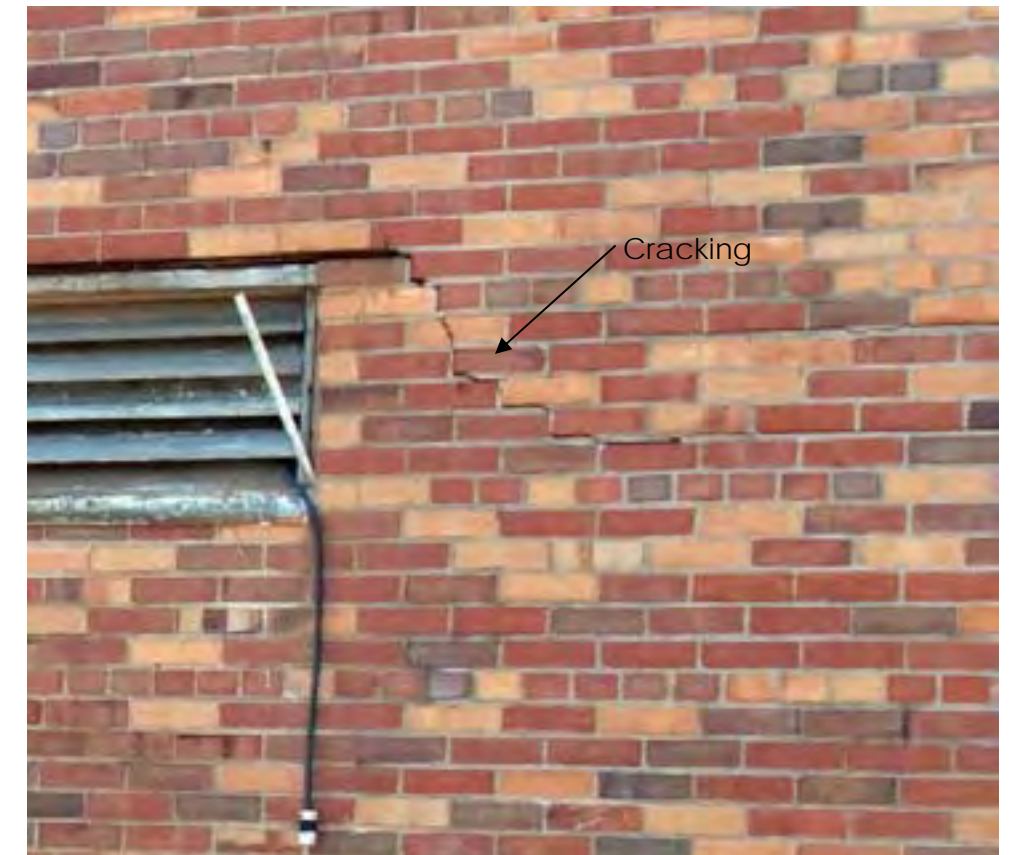

Detail of brick deterioration. 2013

Zone 5—Infrastructure

Sewage Treatment Complex

The Sewage treatment complex was constructed in response to growing concerns regarding water pollution and increased visitation at Jones Beach. Between 1930 and 1950, visitation at Jones Beach increase ten fold. Therefore there was also a ten fold increase in sewage.

The Sewage Treatment Complex includes a number of structures, most of which are still in use today. Structures still in use include the main building, digester building, the trickling plant, grit chamber, tanks and effluent chambers. The greenhouse is no longer an active part of the sewage treatment process.

The Sewage Treatment Complex was constructed to the north of Zach's Bay and to the east of the Wantagh Parkway.

Description—1950's

- All of the building were constructed of Barbizon brick with cast stone trim. The cast stone trim was limited to cap stones. Decorative brick accents were used including soldier, header and projecting courses.
- The buildings featured awning style windows.
- Many of the building featured prominent entrances with windows and oversized doors.
- The Greenhouse was constructed on a concrete platform with a masonry water table (Barbizon brick and cast stone). The upper portion of the greenhouse was metal and glass.
- The Greenhouse also featured a steel armature at the main entrance for moving material in and out of the building.

Alterations

- The buildings have undergone very few changes.
- The windows and doors are original.
- Some of the machinery including piping, pumps, fitting etc. have been replaced due to wear.

Condition

- The condition of the building in the Sewage Treatment Complex ranges from good to poor. Many of the buildings that are still function as vital components are in good condition. The Greenhouse is in very poor condition.
- The Greenhouse has lost many, if not most of the glass units and the metal supports are beginning to fail.



Treatment Plant c.1952



Treatment Plant 2013



Main Building c.1952



Main Building, 2013



Greenhouse c.1952



Greenhouse 2013

Zone 5—Infrastructure High Hill Maintenance Complex

The High Hill Maintenance Complex is located to the east of Zach Bay on the north of Ocean Parkway. The Maintenance complex includes roads, a number of small buildings and a maintenance garage.

Before there was a High Hill Maintenance Complex there was High Hill Beach. High Hill Beach was a small, late 19th century beach and fishing community. High Hill Beach included about 100 residences with a hotels and boardwalk. The community could only be accessed by boat and extended from the bay to the ocean across the island.

High Hill Beach and Jones Beach State Park co-existed for about a decade. Obviously the High Hill residents did not want to give up their property or community but eventually Robert Moses and eminent domain prevailed. Many of the High Hill structures were relocated in Oyster Bay or Hempstead, a few were re-used at Jones Beach but most were demolished in 1940.



High Hill Maintenance Complex, 2013

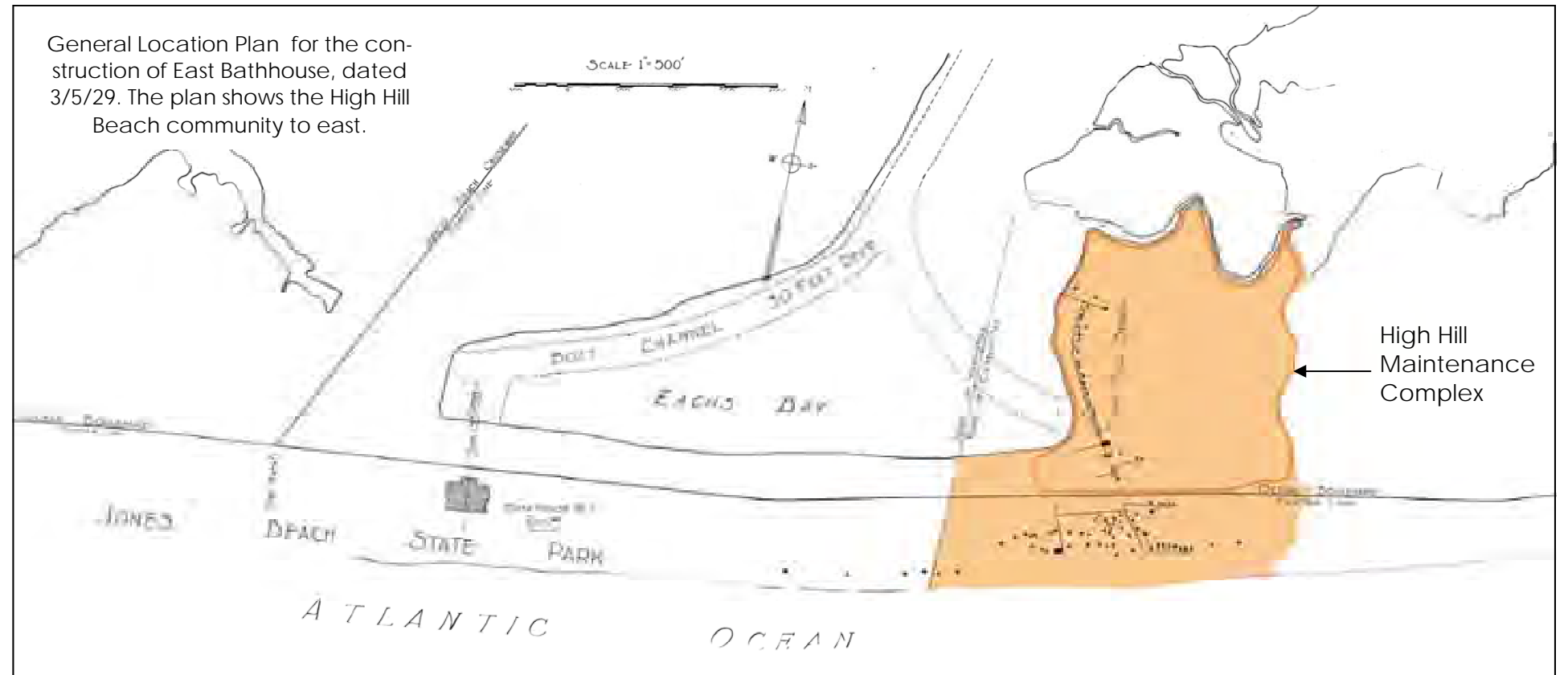

Post Card (date unknown)
High Hill Beach



Post Card (date unknown)
High Hill Beach

Zone 5—Infrastructure High Hill Maintenance Complex

Description

- The current High Hill Maintenance complex is between 150 and 170 acres. The area is to the north of Ocean Parkway and east of Zach's Bay.
- There are currently between 8-10 contributing (NR) buildings in the Maintenance Complex.
- The majority of the buildings appear to have been constructed in the early 1940's.
- The buildings are primarily small, one-story rectangular or square buildings with gabled roofs.
- Many of the buildings are wood frame with wood siding.
- Two buildings are masonry, one brick and one stucco.
- A one-story, five-bay maintenance garage is constructed of Barbizon brick. The building has a new asphalt shingled roof.

Alterations

- The buildings have undergone a number of changes.
- Some of the windows and doors have been replaced and new openings have been created.

Condition

- With the exception of the five bay maintenance garage the condition of the buildings in the High Hill Maintenance Complex is terrible.
- Many of the buildings appear ready to collapse.
- The roofs have failed leading to deterioration of the structural framing.
- The windows and doors are falling out or boarded up.
- Many of the buildings have large holes or gaps in the exterior caused by animals or vandals.
- The buildings are covered with vegetation which is accelerating the deterioration of the buildings.



High Hill Maintenance Complex, 2013



High Hill Maintenance Complex, 2013



High Hill Maintenance Complex, 2013



High Hill Maintenance Complex—5 Bay Garage, 2013



High Hill Maintenance Complex, 2013

Zone 5—Infrastructure

Pump Houses & Transformer Vaults

Jones Beach State Park has over a dozen pump houses and transformer vaults scattered throughout the Park. A number of the buildings were constructed during the Parks period of significance (1925-55). These buildings were executed in the characteristic architectural style of the Park.

Description

- The transformer buildings and electrical vaults are small, one story buildings.
- The majority of the buildings have either flat or hipped roofs.
- The buildings are masonry, constructed of Barbizon Brick with cast stone trim. The cast stone trim is generally reserved for cap stones or sometimes window lintels.
- Decorative brickwork is common, many of the buildings feature projecting courses and soldier or header courses.
- The buildings are generally symmetrical with awning style windows and wood panel doors.

Alterations

- The buildings have undergone a number of changes.
- Some of the windows and doors have been replaced and new openings have been created.
- Many new openings have been created for machinery upgrades including fans, vents, wiring and plumbing.
- The buildings have also been adversely affected by the addition of conduit, vents, fans and equipment placed on the exterior facades.

Condition

- The buildings are generally in fair condition.
- The installation of conduit and fixtures and security grilles on the exterior has resulted in ferrous masonry staining in many locations.
- Roofs were not inspected as part of this survey.



Transformer Vault, 2013



Transformer Vault, Marine Theater, 2013

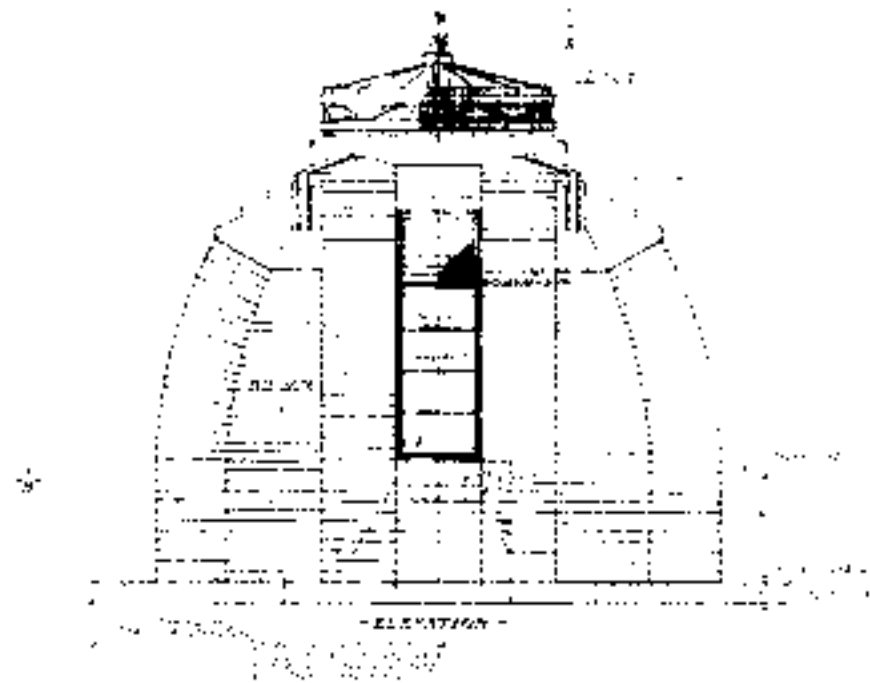

Original Drawing—Well House #1
1934—Demolished



Pump House, 2013

Zone 5—Infrastructure

Fort Benedict Reservoir

The Fort Benedict Reservoir was constructed between 1929-35 to supplement the water held in the Water Towers.

Description

- The Fort Benedict Reservoir is primarily constructed below ground.
- The section of the building above ground is a concrete bunker constructed into the hillside.
- The interior of the structure features a wide open space designed to hold thousands of gallons of water.
- A ladder originally extended down from the roof into the structure.

Alterations

- The buildings is no longer used as a water reservoir.
- A large garage opening has been cut into the façade. A roll down garage door was installed in the opening.
- The building is currently used for maintenance storage.

Condition

- The buildings are generally in fair condition.



Fort Benedict Reservoir, 2013.



Interior of Fort Benedict Reservoir, 2013.

Zone 5—Infrastructure

Watchman's Booth

Jones Beach required a number of watchman's booths for security. These building were located throughout the Park, but especially at the Parking Fields and the far east and west ends of the Park.

Description

- The Watchman's Booth is a small, octagonal building with windows on all faces.
- The building is completely clad in bronze—from the roof to the window sashes.
- A bronze lantern with green glass tops the structure.

Alterations

- The buildings has been moved to its current location. The Watchman's Booth is now used as a ticket booth for one of the Parking Fields.
- The building does not appear to have been altered.

Condition

- The structure appears to be in fair condition.
- Corrosion is apparent on the bronze.



Watchman's Booth, 2013



Watchman's Booth, 2013



Zone 5—Infrastructure

Staff Residences - LI 31—33

- Jones Beach State Park includes three residences for Park's Staff. The staff housing is located at the west end of the Park on the north side of Bay Parkway. The three buildings are set on a slight rise. The 'Superintendents House' (LI-33) and other two residences were constructed in 1932.

Description

- All three buildings are Colonial Revival structures typical of those constructed elsewhere on Long Island in the early 20th century.
- All of the buildings are wood frame with wood shingles and asphalt shingled roofs.

Alterations

- All of the buildings have had garages and small porches added.
- The original wood shingle roofs have been replaced with asphalt shingles.
- The porches have been enclosed.

Condition

- The buildings are generally in fair condition.

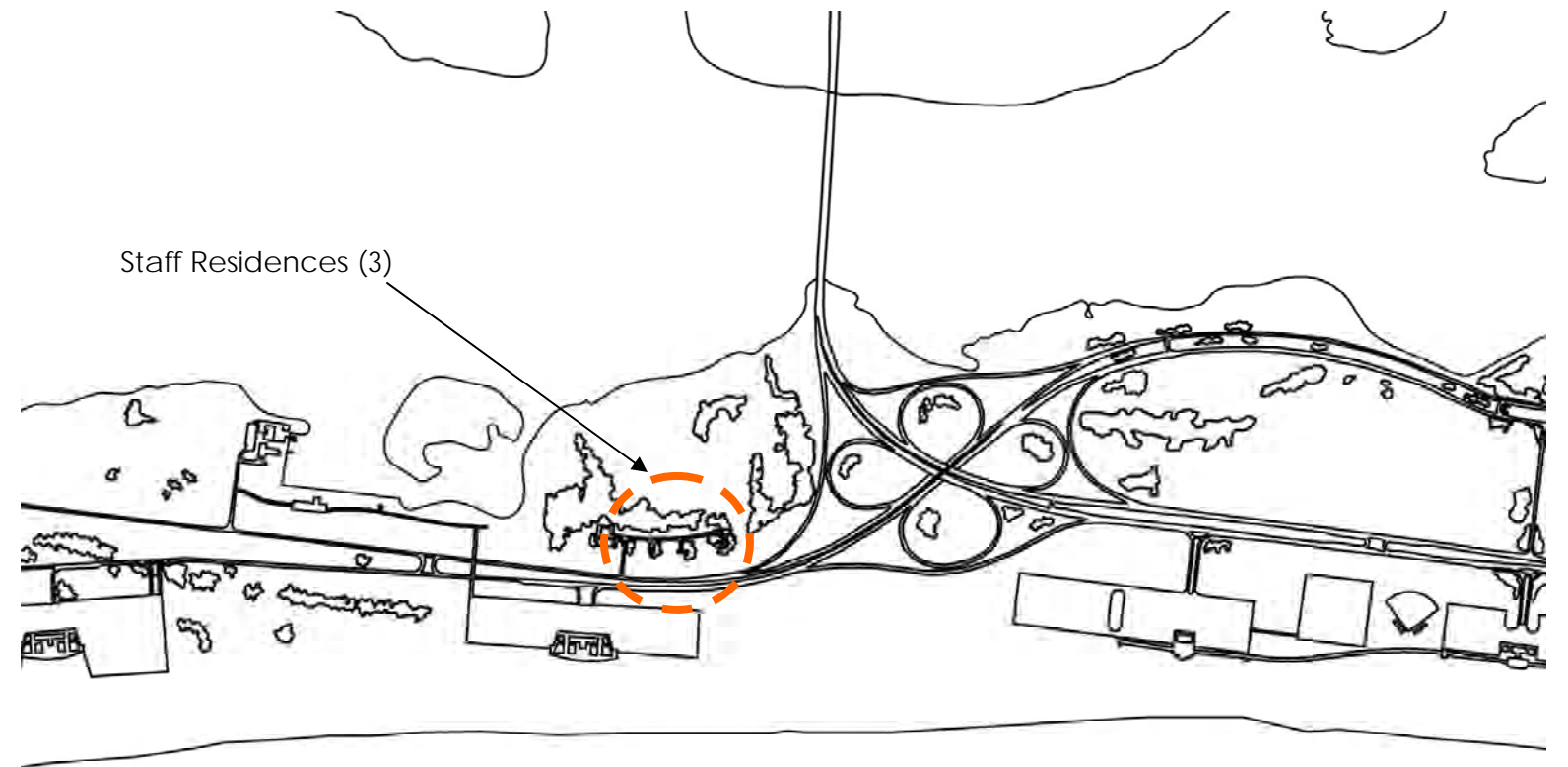

West End of Jones Beach State Park



Staff Residence, LI-31, 2013



Staff Residence, LI-32, 2013



Staff Residence, LI-33, 2013

ZONE 5—INFRASTRUCTURE : USE, SIGNIFICANCE & PRESERVATION

SPACE & USE

Infrastructure :

Infrastructure in the Park included maintenance areas, concession support areas, water and septic services, electrical service, Police, and staff housing.

SIGNIFICANCE

The infrastructure at Jones Beach is significant:

1. As important features of the original Park Design as well as example of the vast network of services buildings that allowed the Park function.
2. For the architectural design. Many of the building identified in this section contributed to the Jones Beach aesthetic by the use of materials and Art Deco architectural style.

Significant Elements include:

1. **Materials:**
 - Barbizon brick. Decorative brick work was also used on many building (projecting courses, soldier & header courses)
 - Cast Stone. Cast stone was used as accent element on many buildings, the more prominent or more public building, the more cast stone was used. Decorative cast stone was only used on public buildings.
 - Copper, glass and wood trim were used on many buildings and contributed to the overall Jones Beach aesthetic.
 - Steel & glass structure of the Greenhouse.
 - Bronze—Watchman’s Booth.
 - Wood framing & siding.
2. **Architectural Style/Scale:**
 - The buildings maintain the low, horizontal character of many of the buildings at Jones Beach.

Period of Significance: 1930-1953

TREATMENT

Recommendations: Rehabilitation

Retention and preservation of Historic Materials

1. The impact of alterations, repairs and additions should be weighed of their effect on the Park design and historic fabric. Code requirements specifically the ability to meet health and safety, energy codes and ADA requirements should be addressed without damaging historic spaces, features or finishes.

Repair of Historic Materials and Features

1. Historic features are threatened by deterioration. When necessary deteriorated fabric should be replaced in kind but the primary goal should be the preservation of historic fabric.
2. The historic buildings at the High Hill Complex should not be allowed to be demolished by neglect.

Replacement of Missing Historic Features

1. The wood porch that connected the Gas Station and Pump Station should be re-established.
2. Windows and doors should be replaced as necessary with units that better replicate the historic configuration.

**ZONE 6: ZACH'S BAY
& THE MARINE THEATER**

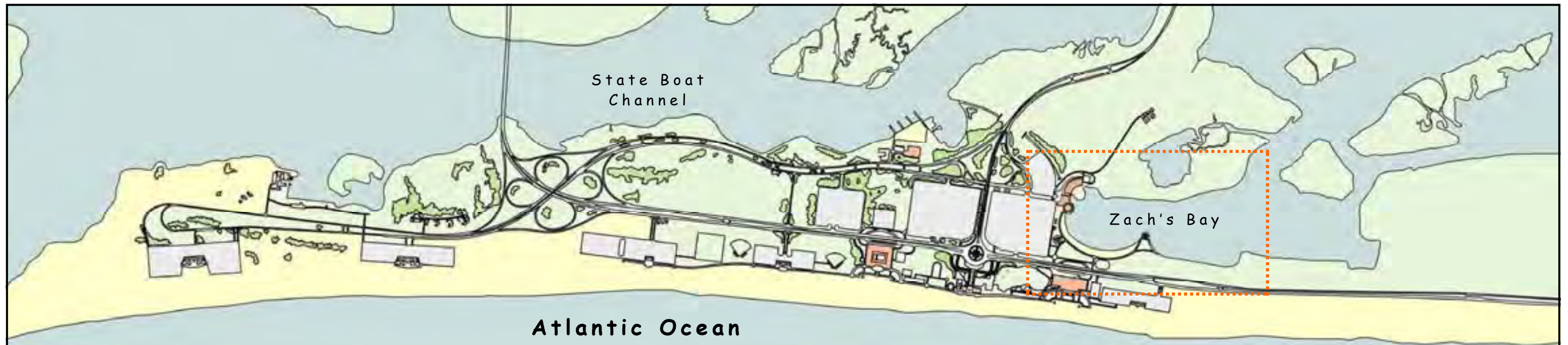

Atlantic Ocean

*Zone 6: Zach's Bay
& The Marine Theater*

*Jones Beach State Park
Wantagh, Long Island
New York*

*New York State Office of Parks,
Recreation & Historic Preservation*

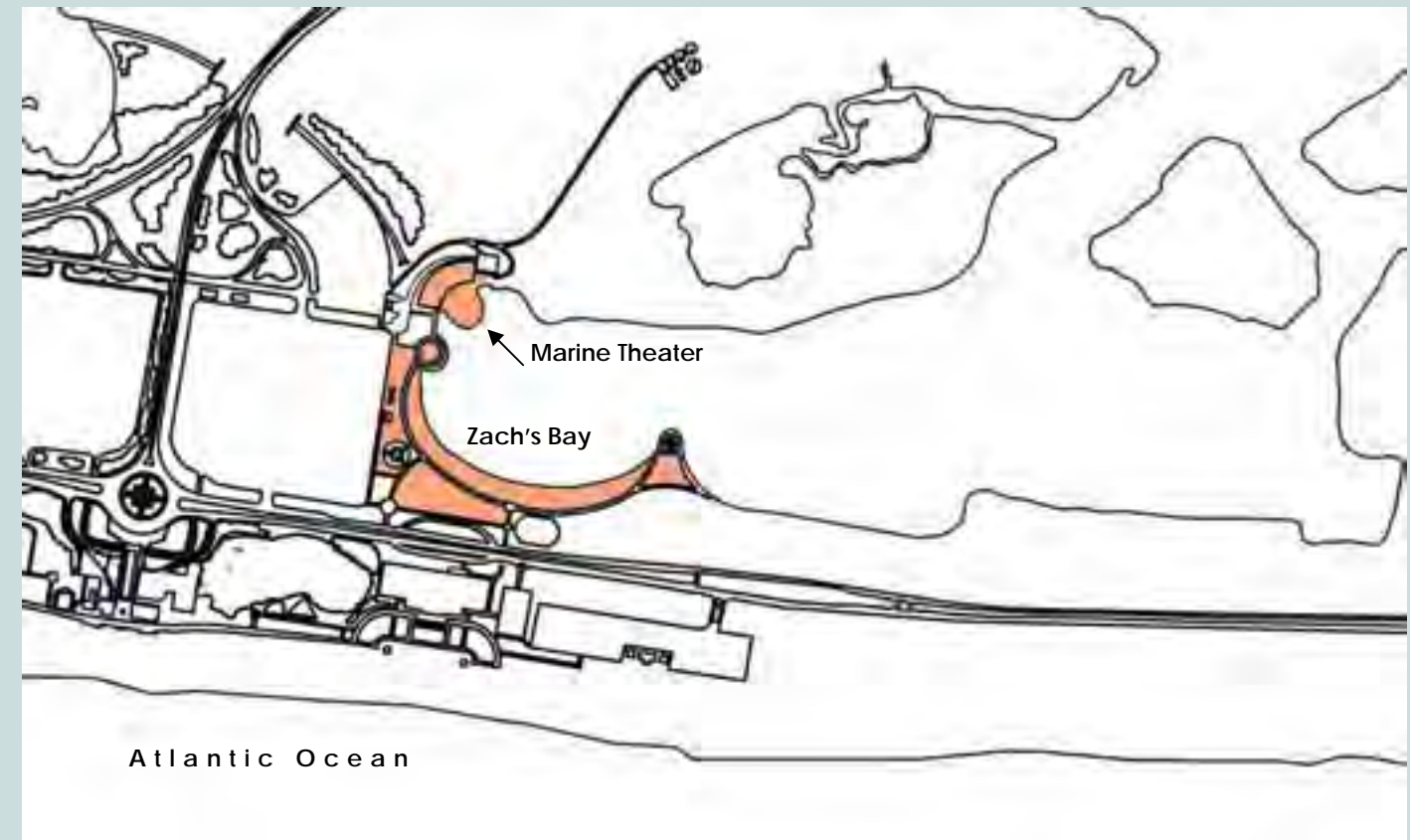

Atlantic Ocean



Zone 6—Zach's Bay & The Marine Theater

Jones Beach may be primarily known for its wide expanse of beach along the Atlantic Ocean but the Park also features impressive bay side features.

Zach's Bay is a large still water bay located on the north side of the Park. The bay is defined by a sweeping crescent of sand that lines the south side of the bay. The Bay featured swimming, diving, sunbathing as well as service amenities.

The northwest corner of the Bay was dominated by a huge Art Deco amphitheater, The Marine Theater. The theater's stage was originally set in the Bay, separated from the theater seating by a narrow channel of water.

Unfortunately, many of the significant features of the Marine Theater have been lost leaving the building with little historic or architectural integrity.

ZACH'S BAY

DESCRIPTION

- Zach's Bay is a large, still water bay. The Bay is used for swimming, boating and the Marine Theater.
- Zach's Bay was largely constructed as part of Jones Beach. Early drawings indicate a rough bay in the area, but the current shape was completely man made.
- Zach's Bay was completed as part of the first building campaign at Jones Beach. The area, including the Bay and support structures were complete by 1932-33.
- The original buildings at Zach's Bay were designed by Herbert Magoon and approved by Earle Andrews.

Buildings:

- There are two primary buildings at Zach's Bay, a comfort station and cafeteria building. The area also featured a few small support buildings. The primary buildings at Zach's Bay are far less ornate than many of the structures lining the Boardwalk. The character of these buildings is more in line with the Park's comfort stations or infrastructure buildings.
- The comfort station and cafeteria are located on a narrow strip of grass between Zach's Bay beach and Parking Field 5.
- It is important to note that in the case of Zach's Bay the more significant façade is the north elevation, which faces Zach's Bay.



Detail of Map of Jones Beach c. 1950

DESCRIPTION

Landscape:

- The east and west ends of the Zach's Bay area are marked by circular plaza's that extend out into the bay and the south boundary is marked by Ocean Parkway. The far north shore of the Bay is not accessible to the public.
- Zach's Bay was originally slightly less formally landscaped than the core of Jones Beach. The area featured large expanses of grass with key areas marked by rough lines of hedges.
- The only example of the formal Parterre landscape style is at the Pavilion Plaza. The Pavilion Plaza is circular, with a central garden area with walkways extending out like spokes on a wheel. The center of the wheel featured closely trimmed hedges and lawn area set out in a geometric pattern. Awning covered pavilions lined the outer perimeter of the circle.
- Many, if not all of the landscape features have been lost. Areas have been paved and trees and hedges removed. However, many of the pathways and fundamental areas remain which would facilitate reestablishing sections of the landscape.
- Original landscape features Zach's Bay included a playground area shielded by trees, a diving platform, & the yacht basin. Later the Yacht basin was converted into a pedal boat launch. A kindergarten was added later as were play fields and a miniature golf course (The Wood Pile). The area now features the beach, viewing plazas, picnic area.

ZACH'S BAY COMFORT STATION

DESCRIPTION

- The Zach's Bay Comfort Station was designed by Herbert Magoon in 1932.
- The comfort station provided restrooms, a smoking room, umbrella rental counter and Park offices at Zach's Bay.
- The building is a low, one-story, horizontal building.
- The building is approximately 4000 square feet including the open porch and umbrella rental area.
- The Comfort Station was constructed of Barbizon brick with limestone trim. Limestone was used selectively at other buildings including the West Bathhouse, but it's use is a deviation from the traditional cast stone accent material.
- The building also featured a wide wood fascia.
- On the Bay side elevation the building featured a open porch with brick and stone piers. The narrow piers featured a vertical band of a repeated "x" geometric pattern.
- The windows were originally steel casement set in vertical columns. The doors were wood panel.
- The open awning rental counter featured a roll down screen.
- The building also featured a narrow copper cupola that ran the length of the central block of the building. The cupola featured louvers for ventilation.

ALTERATIONS

- The Zach's Bay Comfort Station has been significantly altered.
- The windows, doors and cupola have all been removed or replaced. The windows have been replaced with inappropriate units that recall the geometric pattern used on the porch piers. The new abundance of ornament considerable alters the building.
- The awning rental counter has also been enclosed with screens that again replicate the repeated "x" pattern.

CONDITION

- The Zach's Bay Comfort Station is in fair to good condition.
- The masonry appears sound without extensive areas of deterioration.
- The wood fascia has small areas of deterioration and could be repainted to extend the service life the material and improve the overall appearance.
- Prominent lighting fixtures have also been added.

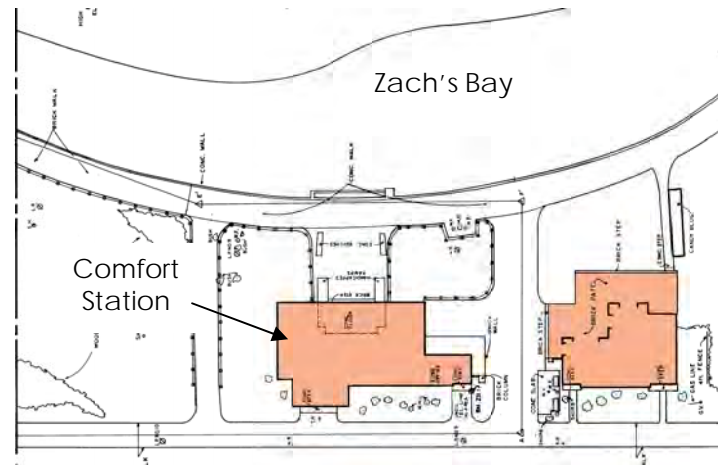

Location Plan, Comfort Station
Zach's Bay 1970's

Floor Plan, Comfort Station
Zach's Bay 1933

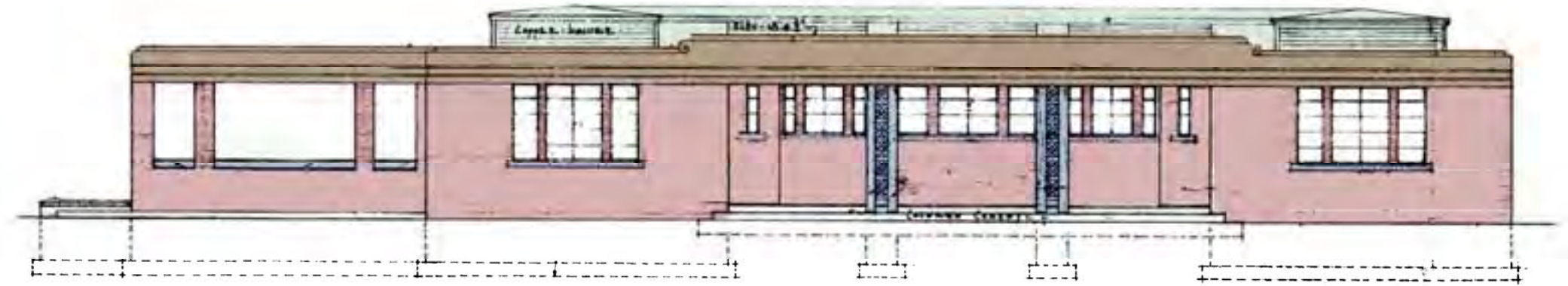
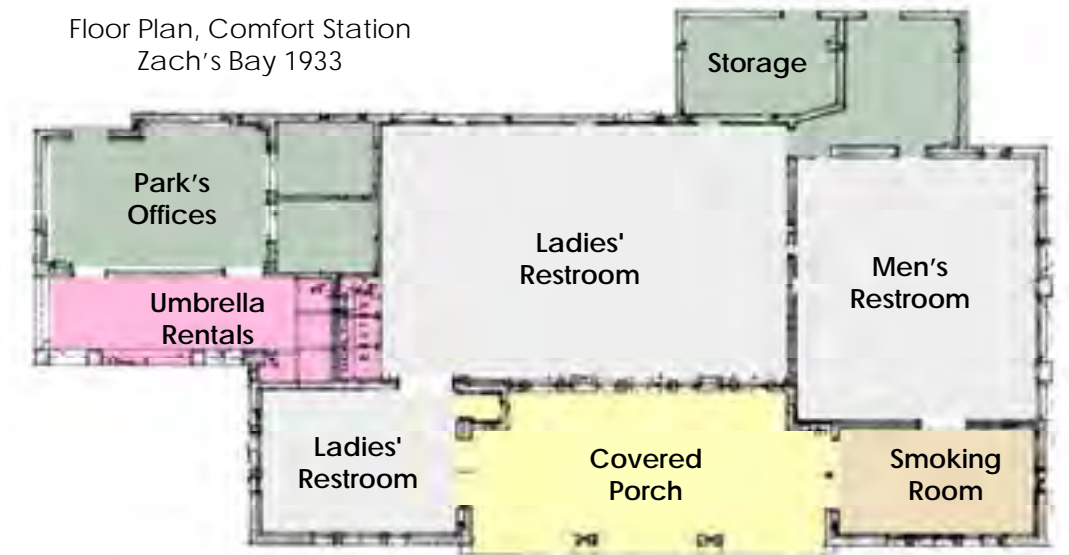

Original Drawing—North Elevation (front) , Comfort Station, Zach's Bay, 1932



South Elevation, Comfort Station, Zach's Bay, 2013

ZACH'S BAY COMFORT STATION

DESCRIPTION

- The Zach's Bay Cafeteria was designed by Herbert Ma-goon in 1932.
- The cafeteria a food service area at Zach's Bay. The cafeteria provided window take out service with out-door seating.
- The seating area was located on the north side of the building overlooking the Bay.
- The building is a low, one-story, horizontal building.
- The Comfort Station was constructed of Barbizon brick with limestone trim. Limestone was used selectively at other buildings including the West Bathhouse, but it's use is a deviation from the traditional cast stone accent material.
- The building also featured a wide wood fascia.
- The windows were originally steel casement set in verti-cal columns. The doors were wood panel.
- The building also featured a narrow copper cupola that ran the length of the central block of the building. The cupola featured louvers for ventilation.
-

ALTERATIONS

- The Zach's Bay Cafeteria has been significantly altered.
- The windows, doors and cupola have all been removed or replaced. The windows on the north have been re-placed with inappropriate units that recall the geomet-ric pattern used on the porch piers of the adjacent Comfort Station. The new abundance of ornament considerable alters the building.

CONDITION

- The Zach's Bay Comfort Station is in fair to good condi-tion.
- The masonry appears sound without extensive areas of deterioration.
- The wood fascia has small areas of deterioration and could be repainted to extend the service life the mate-rial and improve the overall appearance.
- Prominent lighting fixtures have also been added.

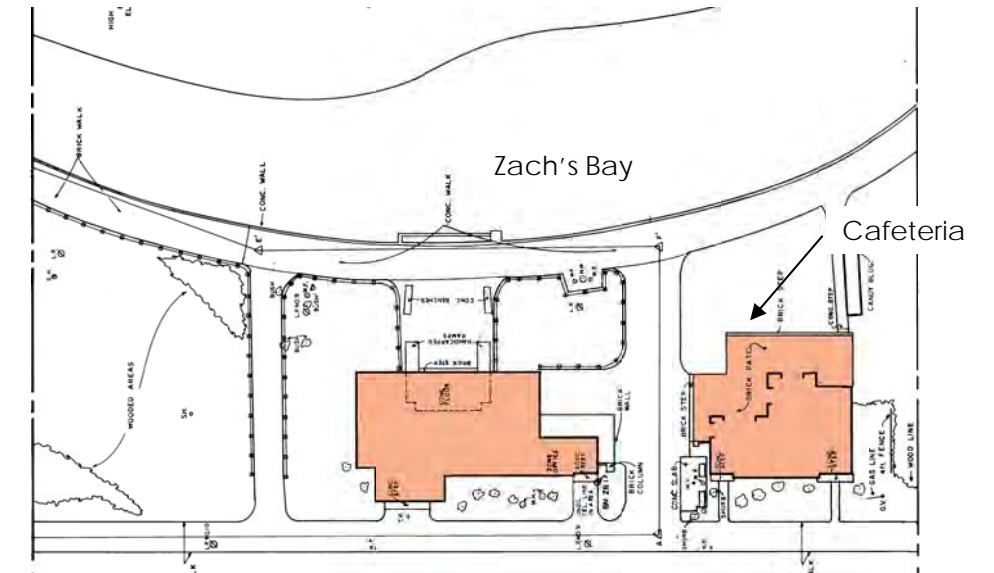

Location Plan, Cafeteria
Zach's Bay 1970's



ZACH'S BAY: USE, SIGNIFICANCE & PRESERVATION

SPACE & USE

Recommendation:

The Zach's Bay .

Description

Sq. Foot (Aprox.)

Zach's Bay Beach

240,000 sq. ft.

Comfort Station :

4,000 sq. ft.

Cafeteria:

2,500 sq. ft.

SIGNIFICANCE

Zach's Bay is significant:

1. As an important component of the original Park Design.
2. For its formal landscape design, especially the use of Parterre landscaping at the pavilion plaza.

The Comfort Station & Cafeteria are significant:

1. For their architectural design. The building reflected careful thought regarding use, layout, materials and ornamental design. These elements are skillfully used together to create a structure that works individually and as part of the overall park design.

Significant Elements include:

1. **Materials.** The use of specific materials was consistent throughout Jones Beach and helped maintain a sense of unity through the large park. Important materials uses at the Comfort Station and Cafeteria include, Bar-bizon brick, limestone and copper and wood trim elements.
2. **Design Elements.** Important design elements include:
 - Low horizontal massing of the building.
 - Symmetry of facades
 - Higher level of ornamentation on primary elevations.

Period of Significance: 1932

TREATMENT

Recommendations: Rehabilitation

Retention and preservation of Historic Materials

1. The impact of alterations, repairs and even code upgrades should be weighed in terms of their effect on historic fabric. Code requirements specifically the ability to meet health and safety, energy codes and ADA requirements should be addressed without damaging historic spaces, features or finishes.

Repair of Historic Materials and Features

1. When necessary deteriorated fabric should be replaced in kind but the primary goal should be the preservation of historic fabric.

Replacement of Missing Historic Features

1. Doors & windows should be replaced as their lifespan comes to an end with windows and doors that replicate the appearance of the original windows and doors.
2. Original openings should be re-established.
3. Where possible the historic landscape should be reestablished around the remaining features.

Removal of Inappropriate modern additions/features

1. Removal of inappropriate ornamentation, specifically the repeated geometric patterns.

MARINE THEATER (1949-52)

DESCRIPTION

EXTERIOR

- The Marine Theater is located in the northwest corner of Zach's Bay. The Theater opened in 1952 with a seating capacity of 9000.
- The Marine Theater was designed and constructed in the post war period between 1949-52. The theater was designed in the Art Deco style consistent with the earlier sections of the Park.
- The Marine Theater is a large open theater based on the classic amphitheater design. The most unique feature of the Marine Theater was the open channel (of water) between the amphitheater and the stage. The amphitheater was constructed of Barbizon brick with cast stone trim. The stage was constructed of poured concrete.

Amphitheater (Seating)

- The amphitheater was five stories high with a raised box seating at the top level.
- The open seating area featured tiered seating extending from the water's edge up to the box seats.
- The rear of the building presented a streamlined appearance with curved walls, columns of windows and rows of flagpoles along the parapet.
- The structure was faced with Barbizon brick with cast stone banding over the windows and along the parapet.

Stage

- The stage was set on an island in Zach's Bay. A narrow channel of water separated the stage from the seating area.
- The stage mimicked the curved, streamlined appearance of the amphitheater.
- The two-story, semicircular stage was anchored by five story concrete towers. The towers featured very modern, Art Deco undulating walls. Performance platforms extended from the towers at various levels. The two-story section of the building housed equipment and storage areas.
- A rear platform on the stage allowed for boats to dock.



Marine Theater, Amphitheater under construction, c. 1949-52.

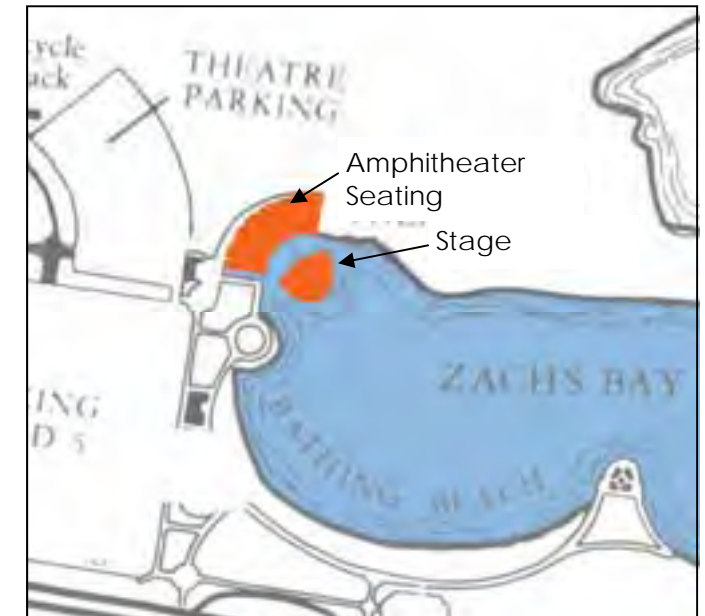

Site Plan, Marine Theater, c.1960's. Note channel between amphitheater seating and stage.



Marine Theater, stage under construction, c. 1949-52.



Marine Theater, Amphitheater stage under construction, c. 1949-52.



Marine Theater, Amphitheater stage, c. 1949-52.



Marine Theater, Amphitheater seating c. 1949-52.



Marine Theater, Amphitheater seating c. 1960's

MARINE THEATER (2013)

DESCRIPTION

EXTERIOR

- The Marine Theater had undergone substantial changes in the decades since its construction. Unfortunately, the changes has drastically altered the structure. It is nearly impossible to see the original Art Deco building though all of the changes. The building has little historic and architectural integrity.
- The alterations to the building have also impacted Jones Beach as a whole. The height of the building allows it to compete with the Water Tower as the significant reference point in the Park.
- The buildings at Jones Beach, were also carefully designed to present a harmonious and complementary whole. Materials, style and design were used to achieve this goal. The materials and design of the 'new/ remodeled' Jones Beach Theater, impacts the entire Park. Detracting from the sence of p



Amphitheater (Seating)

- The amphitheater has been completely remodeled.
- A new tier of seating was added. The new tier covers the top of the historic building and extends out over the building.
- New seating was also added at the base of the amphitheater. The seating now extends to the stage. The unique and character defining feature of the open channel between the seating area and stage has been eliminated.
- The row of open theater boxes have also been eliminated. A new enclosed box with a gabled roof has been installed.
- The color, type and style of the materials used to construct the upper seating tier were completely inappropriate for the Marine Theater and for Jones Beach.

Stage

- The stage is now covered with a large arched canopy. The canopy is partially enclosed with fiberglass panels.
- The color, type and style of the materials used to construct the canopy (including the side panels) were completely inappropriate for the Marine Theater and for

Marine Theater, 2013

